



This is a digital copy of a book that was preserved for generations on library shelves before it was carefully scanned by Google as part of a project to make the world's books discoverable online.

It has survived long enough for the copyright to expire and the book to enter the public domain. A public domain book is one that was never subject to copyright or whose legal copyright term has expired. Whether a book is in the public domain may vary country to country. Public domain books are our gateways to the past, representing a wealth of history, culture and knowledge that's often difficult to discover.

Marks, notations and other marginalia present in the original volume will appear in this file - a reminder of this book's long journey from the publisher to a library and finally to you.

Usage guidelines

Google is proud to partner with libraries to digitize public domain materials and make them widely accessible. Public domain books belong to the public and we are merely their custodians. Nevertheless, this work is expensive, so in order to keep providing this resource, we have taken steps to prevent abuse by commercial parties, including placing technical restrictions on automated querying.

We also ask that you:

- + *Make non-commercial use of the files* We designed Google Book Search for use by individuals, and we request that you use these files for personal, non-commercial purposes.
- + *Refrain from automated querying* Do not send automated queries of any sort to Google's system: If you are conducting research on machine translation, optical character recognition or other areas where access to a large amount of text is helpful, please contact us. We encourage the use of public domain materials for these purposes and may be able to help.
- + *Maintain attribution* The Google "watermark" you see on each file is essential for informing people about this project and helping them find additional materials through Google Book Search. Please do not remove it.
- + *Keep it legal* Whatever your use, remember that you are responsible for ensuring that what you are doing is legal. Do not assume that just because we believe a book is in the public domain for users in the United States, that the work is also in the public domain for users in other countries. Whether a book is still in copyright varies from country to country, and we can't offer guidance on whether any specific use of any specific book is allowed. Please do not assume that a book's appearance in Google Book Search means it can be used in any manner anywhere in the world. Copyright infringement liability can be quite severe.

About Google Book Search

Google's mission is to organize the world's information and to make it universally accessible and useful. Google Book Search helps readers discover the world's books while helping authors and publishers reach new audiences. You can search through the full text of this book on the web at <http://books.google.com/>



3 3433 08243881 7

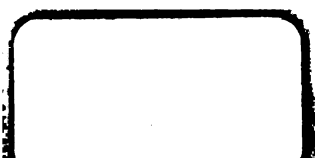



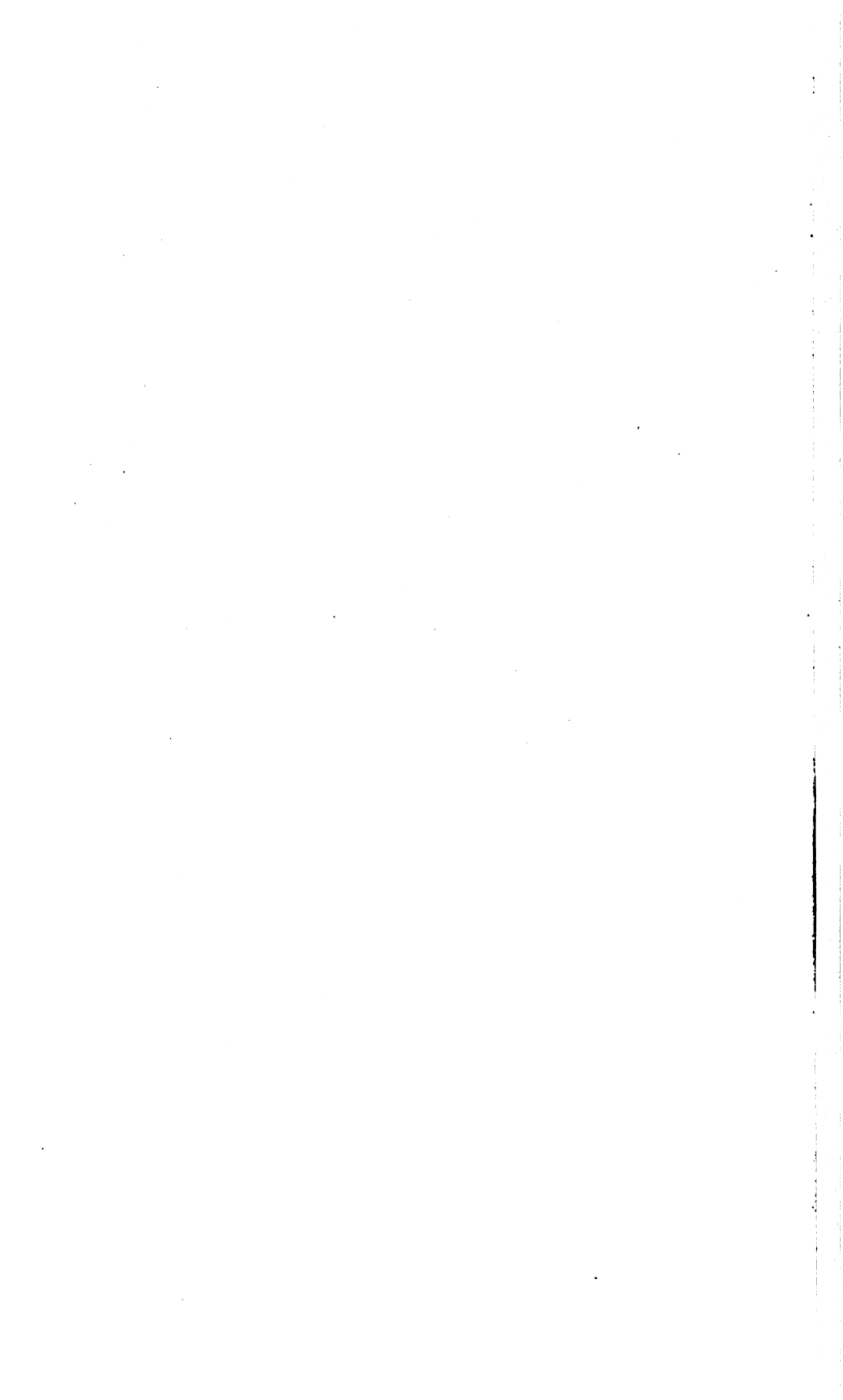

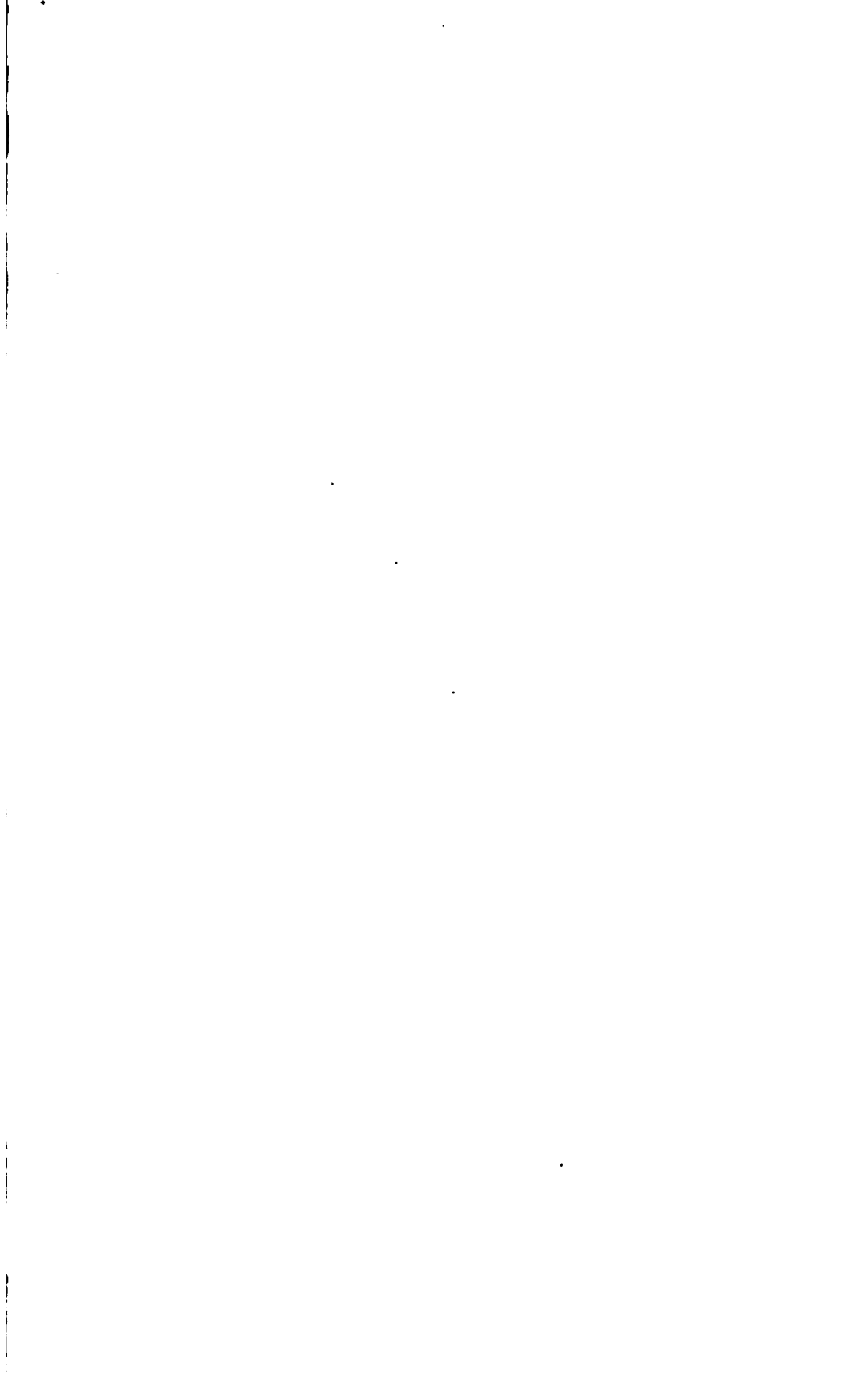

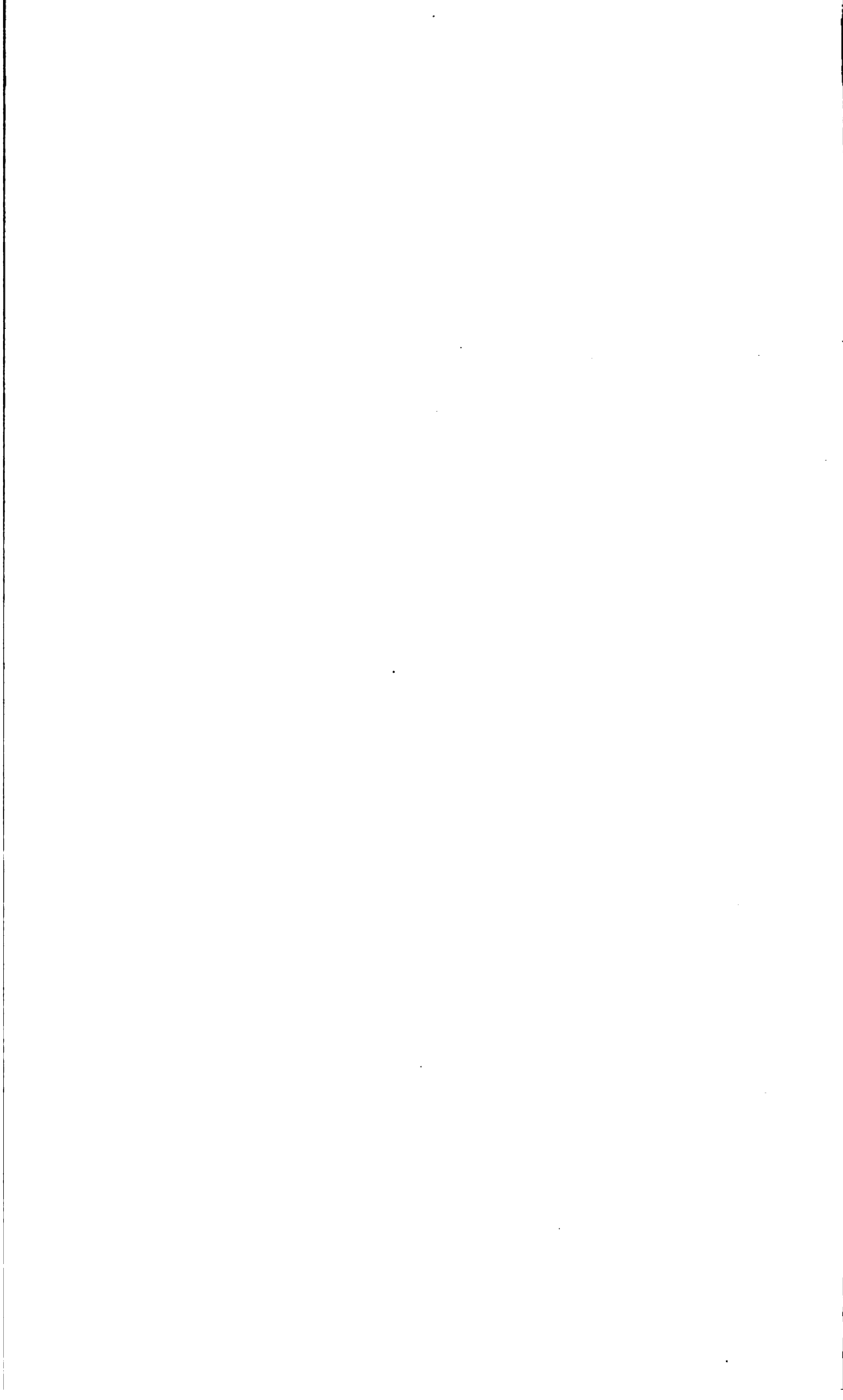

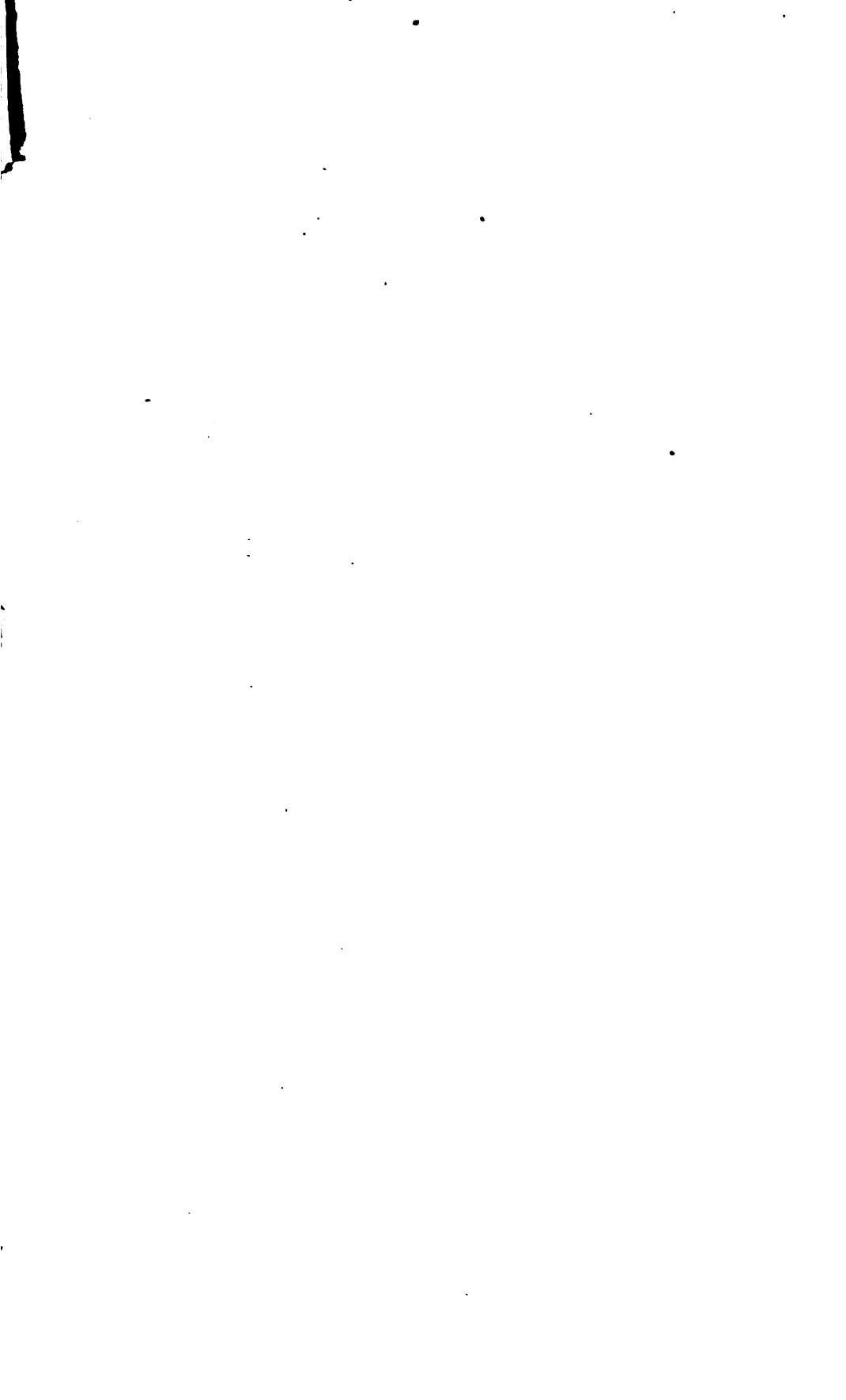

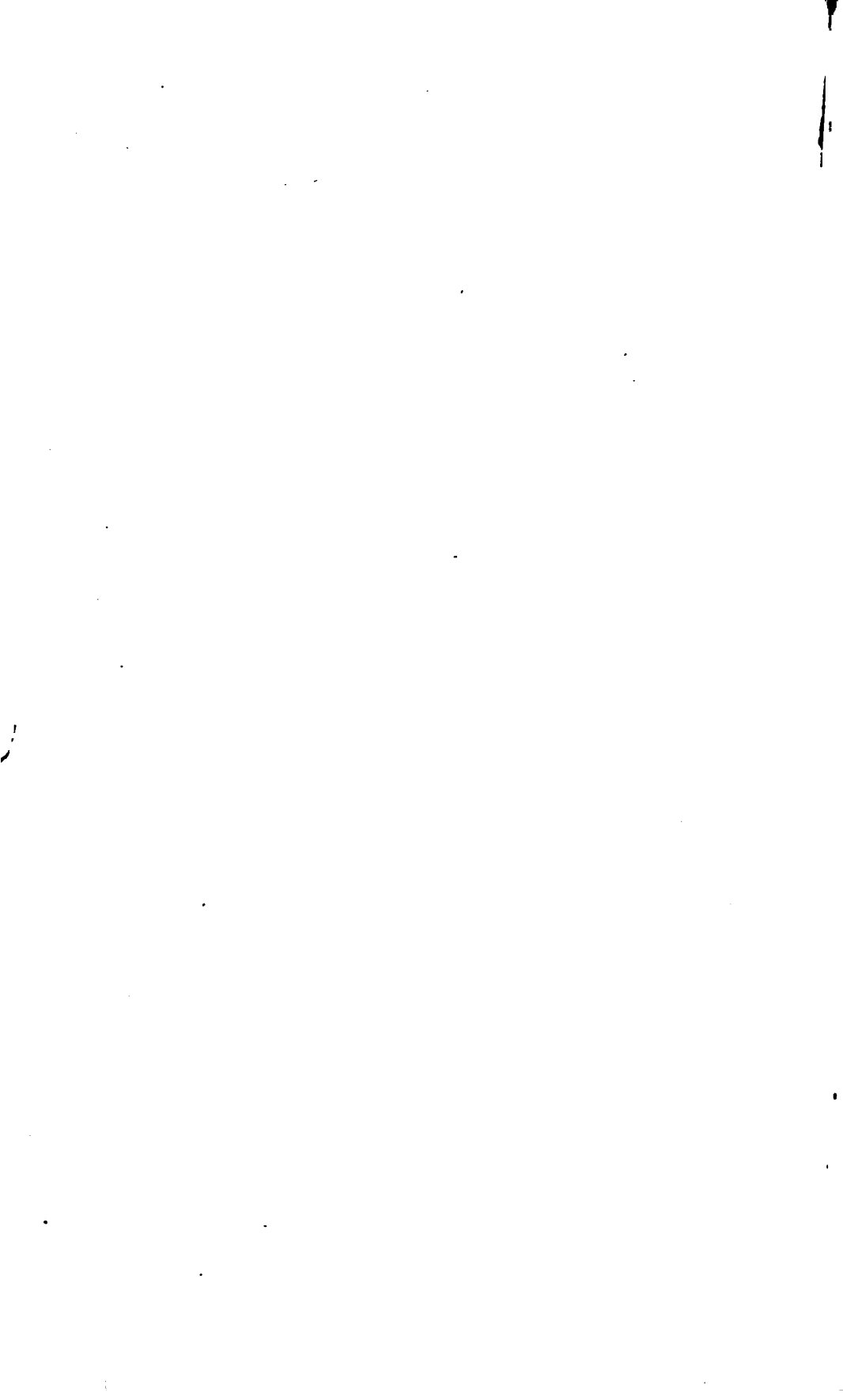

BIHĀR PEASANT LIFE,

BEING

A DISCURSIVE CATALOGUE

OF THE

SURROUNDINGS OF THE PEOPLE OF THAT PROVINCE, .

WITH MANY ILLUSTRATIONS FROM PHOTOGRAPHS TAKEN
BY THE AUTHOR.

Prepared, under Orders of the Government of Bengal,)

BY

GEORGE A. GRIERSON, B.C.S., M.A.S.B., M.R.A.S.,

FELLOW OF THE UNIVERSITY OF CALCUTTA: FORMERLY SANSKRIT AND HINDUSTANI
EXHIBITIONER, TRINITY COLLEGE, DUBLIN.

Calcutta:

THE BENGAL SECRETARIAT PRESS.

LONDON: TRÜBNER & Co., 57 & 59, LUDGATE HILL.

1885.

G. A. Grierson

34936



ROY WOOD
JUN
1940

TO

Sir Augustus Ribers Thompson,

K.C.S.I., C.I.E.

IN GRATEFUL ACKNOWLEDGMENT

OF THAT COUNTENANCE AND ASSISTANCE WITHOUT WHICH IT WOULD

NEVER HAVE BEEN WRITTEN,

THIS BOOK

IS DEDICATED

BY

THE AUTHOR.

Bankipore, 4th April 1885.



INTRODUCTION.

WHILE this work professes to be a catalogue of the names used by the Bihar peasant for the things surrounding him in his daily life, yet, in order to relieve the dryness which such a mere list would possess, the writer has attempted to give a description, more or less complete, of that life and of its character and incidents. The book is in fact a discursive catalogue, and it is hoped that it may serve as a solid foundation for more elaborate disquisitions on the Bihar *raiyat* and his surroundings.

Such a work as this is nothing if not accurate, and no ordinary pains have been spared to compass the greatest accuracy possible. Existing treatises on Indian rural life are not always trustworthy; and as it is impossible to tell what is and what is not correct in them, the writer has avoided taking them as the groundwork of his compilation. Every word in this book has been collected from the mouths of the people, and noted on the spot where it was spoken, either by the writer himself or by one of his assistants. When the work began to assume shape, it was carefully compared with every available book of reference, and where discrepancies occurred, they were either reconciled or explained. Finally the proof-sheets have been circulated to all the Bihar districts, and have been again checked on the spot by competent observers, different from the original persons who collected the materials on which the book was founded.*

So far, therefore, as its contents go, this book may claim to be entirely original, and the writer hopes, to a certain degree, accurate. No originality can, however, be claimed for its general system and arrangement. This is closely modelled on Mr. Crooke's "Materials for a Rural and Agricultural Glossary of the North-Western Provinces

* The writer would here tender his thanks to the various district officers of Bihar, who have spared no trouble in having this local checking performed in a satisfactory manner. The amount of new information gained, and of mistakes and misprints corrected through their help, has been very considerable.

and Oudh.”* The writer has followed him very closely in the arrangement of his matter, and in many cases has not scrupled to use his very words when they were the most suitable that could be adopted. The vernacular words embodied in this book have in fact been brought together from two sources, viz. the writer’s own private researches during the past seven years, checked and supplemented by actual translations of the words given by Mr. Crooke’s work made by the writer’s assistants once and sometimes twice over in every district of Bihār. It will thus be seen how much the writer is indebted to the latter gentleman. Mr. Crooke’s book differed from the present work in being to some extent a compilation from existing dictionaries; and as these were not all of them as accurate as could be wished, it was impossible that it should not contain some mistakes. But as one who has probably worked through it with more minute attention than most people, the writer gladly bears witness to its general accuracy. This may be considered as really wonderful, when the extremely slovenly scholarship of some of the books on which Mr. Crooke had to depend is taken into account.

In the present work every native word is written twice over—once with accuracy in the native character for those who are able to read it, and once in the English character for those who are not acquainted with the Indian vernaculars. This transliteration does not pretend to be scientifically accurate. Such a transliteration with its diacritical dots and dashes would only puzzle those for whom it is intended, viz. those who are ignorant of the language. All that has been attempted for them is to give them a general idea of the correct pronunciation of the words, without professing to tell them the exact pronunciation, which they hardly require, and which would be difficult to do. For these persons all that is necessary is that they should pronounce the vowels as in Italian, and the consonants as in English, and they will then approach sufficiently near to the way in which the natives themselves pronounce the words.† For those who are acquainted with the

* Allahabad, 1879. Printed at the North-Western Provinces and Oudh Government Press. The writer would take this opportunity of acknowledging his indebtedness to Mr. Crooke for this really admirable work. Without it the present book could never have been written without an expenditure of labour which few district officials like the writer would have been able to bestow.

† The system of transliteration adopted may be briefly described as the Jonesian system, with every possible diacritical mark omitted. In pursuance of this the cerebral letters are given no dots, and, as nearly every final vowel is long, the long mark has been omitted from final vowels.

vernacular languages, no instructions for pronouncing the words in their vernacular dress are necessary.

In quoting Arabic and Persian words in the Nāgri character, the dots, which are sometimes used to indicate an original *s*, &c., are omitted, for the reason that the words are given as they are pronounced in Bihār, and that all the dots in the world will not make a Bihāri pronounce a *s* as other than *j*, or a *sād* as other than *s*.

In order to understand the meaning of the words which the writer has used to express locality, it is necessary to explain that, under the name Tirhut, he has included the whole tract which lies between the river Gandak on the west and the river Kosi on the east, and which is bounded on the north by the Nepal frontier and on the south by the Ganges. He, therefore, indicates under this term not only the districts of Muzaffarpur and Darbhanga, but also North Bhagalpur and North Munger (Monghyr). This was rendered necessary by the language of these latter tracts being practically the same as that of Darbhanga. By North-West Tirhut he means the Sitāmarhi and Sadr subdivisions of Muzaffarpur; by South-West Tirhut, the subdivision of Hajipur; by North-East Tirhut, the Sadr and Madhubani subdivisions of Darbhanga and the Supaul subdivision of North Bhagalpur; and by South-East Tirhut, the Tajpur subdivision of Darbhanga, North Munger, and the Madaipūra subdivision of North Bhagalpur. By North Bihār he means all Bihār north of the Ganges, and by South Bihār all Bihār south of it. When he speaks of the east or the west, the north-east or the north-west, he means, of course, the east, west, north-east, and north-west respectively of Bihār.

One more word of warning regarding these localities. When the writer says that a word is used in a certain place, he does not mean by implication that it is not used anywhere else. He means simply that the word has been noted by him in such and such a place, and not elsewhere. That it may be used elsewhere is very possible, and any notes on this or kindred topics addressed to the writer, care of the Secretary to the Bengal Government, Revenue and General Departments,* will be gladly welcomed.

Regarding the illustrations, they are all (with one or two small exceptions) lithographed or cut on wood from photographs taken by

* The writer would also suggest, as an excellent field for the discussion of the various points noted in this book, a magazine called *Punjab Notes and Queries*, edited by Captain Temple, Cantonment Magistrate, Amritsar. Although published in and taking its title from the Panjāb, this useful little work deals with the whole of Northern India.

the writer, who is glad to be able to thank Mr. Schaumburg and the students of the Government School of Art, Calcutta, for the excellent pictures they have produced out of what, he must confess, were too often very indifferent photographs. The difficulties experienced by the writer in taking some of these pictures were great. The most ludicrous reports spread through the city concerning his work. The camera of course was looked upon as a fearful engine of destruction, and sometimes half an hour has been wasted in futile diplomacy to persuade an old lady to allow the lens to be pointed at her. Under these circumstances photographs had almost always to be taken by the instantaneous process, which, however certain it may be in the hands of the professional, frequently disappoints the mere amateur. The last photograph the writer took—that of a native house—was spoilt because the grandmother of the family refused to allow any of the children to appear in the picture, her reason being that the Government was building the bridge across the Gandak and wanted children to bury under its foundations. Just, however, as the plate was exposed, one of the little boys determined to immortalize himself, and leaped in front of the lens to the dismay of the female members of his family. He had his wish in appearing in the picture, but he was so near the lens that he covered half of it with his shoulders. On other occasions the writer was believed to be collecting carts and boats for the Egyptian war, or to be counting the wells in the country, because he knew a famine was approaching, and so on *ad infinitum*. However, the pictures were finally taken, and, such as they are, are certainly accurate representations of the originals.

In conclusion the writer has to draw attention to the thoroughness and accuracy with which his assistants, Munshi Dilawar Ali and Munshi Moti Lal have done their portion of the work. The former has, the writer much regrets to say, died since the above was first written. The latter has been his assistant to the last, and the writer begs to record his high sense of his industry and intelligence, and to recommend his services to the favourable notice of Government.

ADDENDA ET CORRIGENDA.

A GOOD many types have broken in the process of printing. Advantage is taken of this list of errata to add information obtained after the sheets went to press.

These *addenda* and *corrigenda* are printed on one side of the paper only, and can be cut up and pasted in the appropriate places in the book.

| Page. | Line. | Section. | For | Read. |
|-------|--------------------------------|----------|----------------------|--------------------------|
| 3 | 5 | | समधर ... | समधर. |
| 5 | | 27 | फहोडा, फहोरा | फहोडा, फहोरा. |
| 10 | 16 | | ढकीया ... | ढकीया. |
| 13 | | 63 | फहया ... | फहया. |
| 17 | 4 | | खाना ... | खाना. |
| 21 | 4 | | चावक ... | चावक. |
| 22 | | 113 | बागडोर <i>bagdor</i> | बाग डोर <i>bag dor</i> . |
| 23 | 7 from bottom. | | चखबंघना ... | चखबंघना. |
| 24 | 3 | | बेंतकी ... | बेंतकी. |
| 25 | Last line of foot- note. | | देखे ... | देखे. |
| 26 | | 137 | थपकी ... | थपकी. |
| 27 | 2 | | नदोइ ... | नदोइ. |
| 34 | 2 | | खूँटिहरी ... | खूँटिहरी. |
| 42 | | 230 | पटेकी ... | पटेकी. |
| 44 | | 238 | सूते, सुतेवनियां | सूर्ते, सुर्तेवनियां. |
| 52 | 5 | | ढेंकुहा ... | ढेंकुहा. |
| 58 | | 317 | चबतरा ... | चबुतरा. |
| 63 | 5 | | upper screw ... | upper roller. |
| 63 | Title of illustration. | | CHARKI ... | CHARKHL |





| Page. | Line. | Section. | For | Read. |
|-------|----------|----------|---------------------------------|--------------------------|
| 78 | 15 | | बकसा | बकसा. |
| 85 | | 404 | बकुरा | बकुरा. |
| 87 | 17 | | बुरसा | बुरसा. |
| " | 29 | | गरीव | गरीव. |
| 95 | 1 | | तनाकुवासा | तनाकुवासा. |
| " | 2 | | तनाकुवासा | तनाकुवासा. |
| " | Last ... | | <i>dorasa</i> | <i>dorassa.</i> |
| 96 | 18 | | <i>nariyal</i> | <i>nariyal.</i> |
| 97 | Last ... | | बकुरा | बकुरा. |
| 102 | | 510 | धीकणी | धीकणी. |
| 103 | | 516 | बहुना | बहुना. |
| 105 | | 538 | बकरसान <i>chakar sän</i> | बकरसान <i>chakarsän.</i> |
| 108 | | 558 | <i>thatherar</i> | <i>thathera.</i> |
| 109 | | 567 | बुँटा, बुँटी | बुँटा, बुँटी. |
| 110 | | 570 | नरि | नरी. |
| 111 | | 572 | निषण | निषण. |
| " | | " | <i>kumhain</i> | <i>kumhain.</i> |
| " | | 575 | पिँदुरी | पिँदुरी. |
| 112 | | 584 | बकुरा | बकुरा. |
| 113 | 14 | | बुरे | बुरे. |
| 114 | | 586 | कागणी | कागणी. |
| 117 | 1 | | कोलसुप <i>kolsup</i> | कोलसुप <i>kolsup.</i> |
| 128 | | 660 | बिरहरा <i>birhara</i> | बिरहरा <i>birahra.</i> |
| 134 | | 713 | बईया | बईया. |
| 141 | | 715 | बवण | बवण. |
| 145 | | 732 | जाना <i>jama</i> | जाना <i>jāma.</i> |
| 152 | | 759 | बुँदुर, बुँदुर | बुँदुर, बुँदुर. |
| 153 | 7 | | बतरना | बतरना. |
| 154 | | 766 | <i>sari</i> | <i>sāri.</i> |

| Page. | Line. | Section. | For | Read. |
|-------|----------------|----------|---|----------------------|
| 154 | 3 from bottom. | | विचचि | विचचो. |
| 155 | | 771 | किंकिनि, वृषप, वृषप | किंकिनी, वृषप, वृषप. |
| 157 | 2 from bottom. | | उच | उच. |
| 159 | | 784a | Add—'A homestead is also called डींवा <i>diāra</i> or डींवा <i>diāro</i> in South Bhagalpur.' | |
| 161 | | 786 | After 'goriatta,' add—'or in South Bhagalpur गोरण्टी <i>goranti</i> .' | |
| 164 | 12 | | For 'तरि' read 'तरौ.' | |
| " | | 794 | Add—'Soil mixed with coarse gravel is also कंकरोटिया <i>kankrotiya</i> , and hard rocky soil पथरौटी <i>pathrauti</i> in South Bhagalpur.' | |
| 165 | | 797 | Before 'खिलकट,' insert 'कुराव <i>kurāo</i> ;' and before 'and पौह,' add—'कनिल <i>kanil</i> in South Bhagalpur.' | |
| 166 | 1 | | After 'chānch,' add—'or पड़ परती <i>paḥ parti</i> .' | |
| " | | 801 | After 'melani,' add—'or छिटा <i>chitta</i> ,' and also add—'Irrigation from wells is कुँदिया चास <i>kunriya chās</i> in South Bhagalpur.' | |
| 168 | | 806 | For 'होवती <i>hōvti</i> ' read 'हँवती <i>hōvti</i> .' | |
| " | | 812 | For 'धन कियारी <i>dhan kiyāri</i> ' read 'धनकियारी <i>dhan kiyāri</i> .' | |
| " | | 814 | After 'बीटो <i>bito</i> ,' add—'or बेरो <i>bero</i> .' | |
| 169 | | " | After 'laugāchhi,' add—'or नौगाछी <i>naugāchhi</i> .' | |
| " | | 815 | Add,—'Land producing brushwood is जाँटी <i>jhānti</i> in South Bhagalpur.' | |
| 171 | | 818 | After 'phāran,' add—'and in South Bhagalpur हर समौध <i>har samaudh</i> .' | |
| 173 | | 827 | After 'dahina,' add—'and in South Bhagalpur, उखड़ हाल <i>ukhar hāl</i> .' | |
| ... | | 828 | For 'bhauriya' read 'bhauriya,' and add—'in South Bhagalpur मण्डो जोस <i>mando jot</i> or चीनण्डो <i>chaumandi</i> .' For 'जमाउदी' read 'जमा उदी,' and after 'other names current are,' add—'लमती <i>lamti</i> in South Bhagalpur.' | |



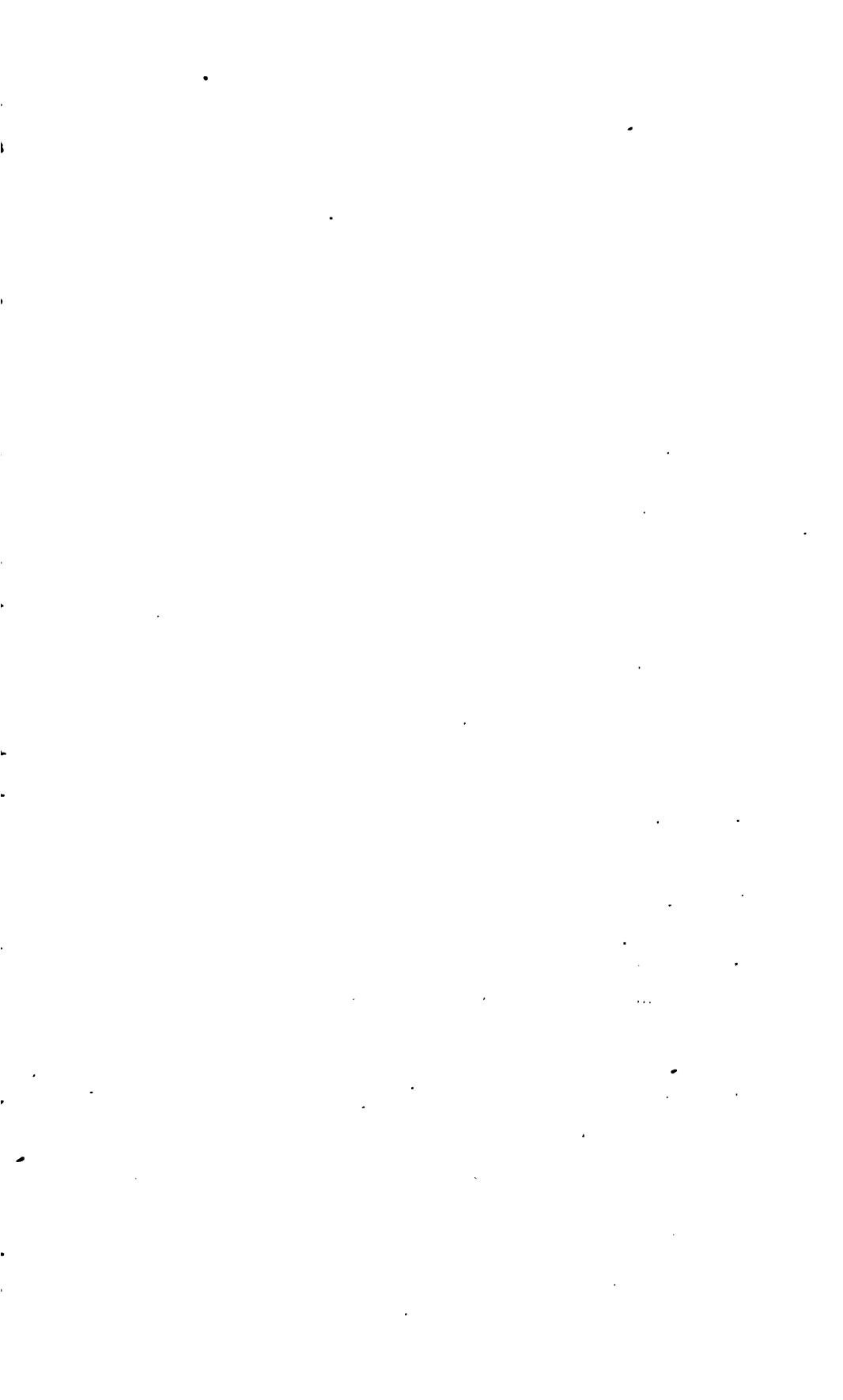

| Page. | Line. | Section. | |
|-------|----------|----------|---|
| 174 | | 830 | For 'हैगात्र' read 'हैगात्र.' |
| ,, | Last ... | | For 'हरकौ बाबा' read 'हरकौ बाबा.' |
| 176 | | 837 | For 'सौंके' read 'सौंके,' and for 'हँकिवा' read 'सँकिवा.' |
| 177 | 2 | | After 'somāta,' add—' or हर समौच har samaudh.' |
| ,, | | 842 | Add—'A ploughman who works for advances is साण्ख saonkh in South Bhagalpur.' |
| 179 | | 848 | Add—'Manure is also called हूरा hūra in South Bhagalpur.' |
| 180 | | 850 | Add—'Heavily-manured land is also said to be पटाख patāēl north of the Ganges.' |
| 182 | | 856 | Add—'Barren seeds are called कुब्बी kubbi in South Bhagalpur.' |
| 183 | 3 | | For 'बावर' read 'बावरा.' |
| ,, | | 859 | After 'barua,' add—'and in South Bhagalpur कुब्बी kubbi.' |
| 184 | | 862 | After 'benga,' add—'and in South Bhagalpur बिचरा bichra or बिहन्तर bihantar. |
| ,, | | 864 | For 'बीहन्तर' read 'बिहन्तर.' |
| ,, | | 864 | Add—'The bamboo on which the seedlings are carried is called धरङ्गी dharangi in South Bhagalpur.' |
| 185 | | 866 | Add—'Hoeing is called केलौनी kelauni or कम्पौनी kamauni in South Bhagalpur.' |
| ,, | | 867 | After 'kelauni,' add—'or कम्पौनी kamauni.' |
| 186 | | 871 | For 'सकालेदा' read 'सकालेदार.' |
| 187 | | 873 | Add—'Cane-cutting is पतौर पारब pataur pārāb in South Bhagalpur.' |
| ,, | | 875 | After 'agra,' add—'or अग्रा alga.' |
| 188 | 1 | | For 'jhārjharāēl' read 'jharjharāēl.' |
| 192 | | 887 | Add—'Treading grain is दमाही damāhi in South Bhagalpur.' |

| Page. | Line. | Section. | |
|-------|----------------|----------|---|
| 192 | | 888 | Add—'The first treading out of the grain is also called <i>खूपा khūa</i> or <i>खोपा khaa</i> , and the second treading <i>तरकार tarjār</i> in South Bhagalpur.' |
| " | 3 from bottom. | | For 'दोगहा <i>dogha</i> ' read 'दोगहा <i>dogaha</i> .' |
| 193 | | 891 | After 'खूपा <i>khūa</i> ,' add—'or <i>खोपा khaa</i> or पौर <i>paur</i> .' |
| 194 | | 894 | Add—'Loose straw that has been threshed is <i>मीरा mīra</i> in South Bhagalpur.' After 'नौदरी,' add—'or in South Bhagalpur गमौरी <i>gabhauri</i> .' |
| " | | 895 | Add—'घोरान <i>ghoran</i> is also used in South Bhagalpur.' |
| 195 | | 896 | After 'थाथेरो,' add—'When applied to <i>jenera</i> (<i>holcus sorghum</i>).' |
| 196 | | 902 | After 'कुरतली,' add—'when between tenant and subtenant.' |
| 198 | | 911 | For 'खूद काशत <i>khūd kāshṭ</i> ' read 'खूदकाशत <i>khuddkāshṭ</i> .' |
| 201 | | 915 | Add—'A man irrigating is in South Bhagalpur लरवाहा <i>larwāha</i> .' |
| 203 | | 918 | After 'धुर्का,' add—'or उपाटा <i>upta</i> .' |
| 204 | | 922 | Add—'The spring is in South Bhagalpur also बूर <i>bhūr</i> or खोपा <i>soa</i> .' |
| 206 | | 939 | Add—The 'wooden framework is called जाला <i>jalāla</i> in South Bhagalpur.' |
| 214 | 5 | | For 'खुपाज' read 'खुपा.' |
| " | | 958 | For 'दूँका' read 'दूँका.' |
| 224 | 14 | | For 'खौरिया' read 'खोरिया.' |
| 226 | 8 from bottom. | | For 'मज' read 'मेज.' |
| 228 | 4 | | For 'रहरैठा' read 'रहरैठा.' |
| " | 6 | | For 'देदो' read 'देदो.' |
| 230 | | 1001 | For 'पटाएज' read 'पटाएज.' |
| 247 | 10 | | For '1464' read '1458.' |

... the ...

... the ...

... the ...

... the ...

... the ...

... the ...

... the ...

... the ...

... the ...

... the ...

... the ...

... the ...

... the ...

... the ...

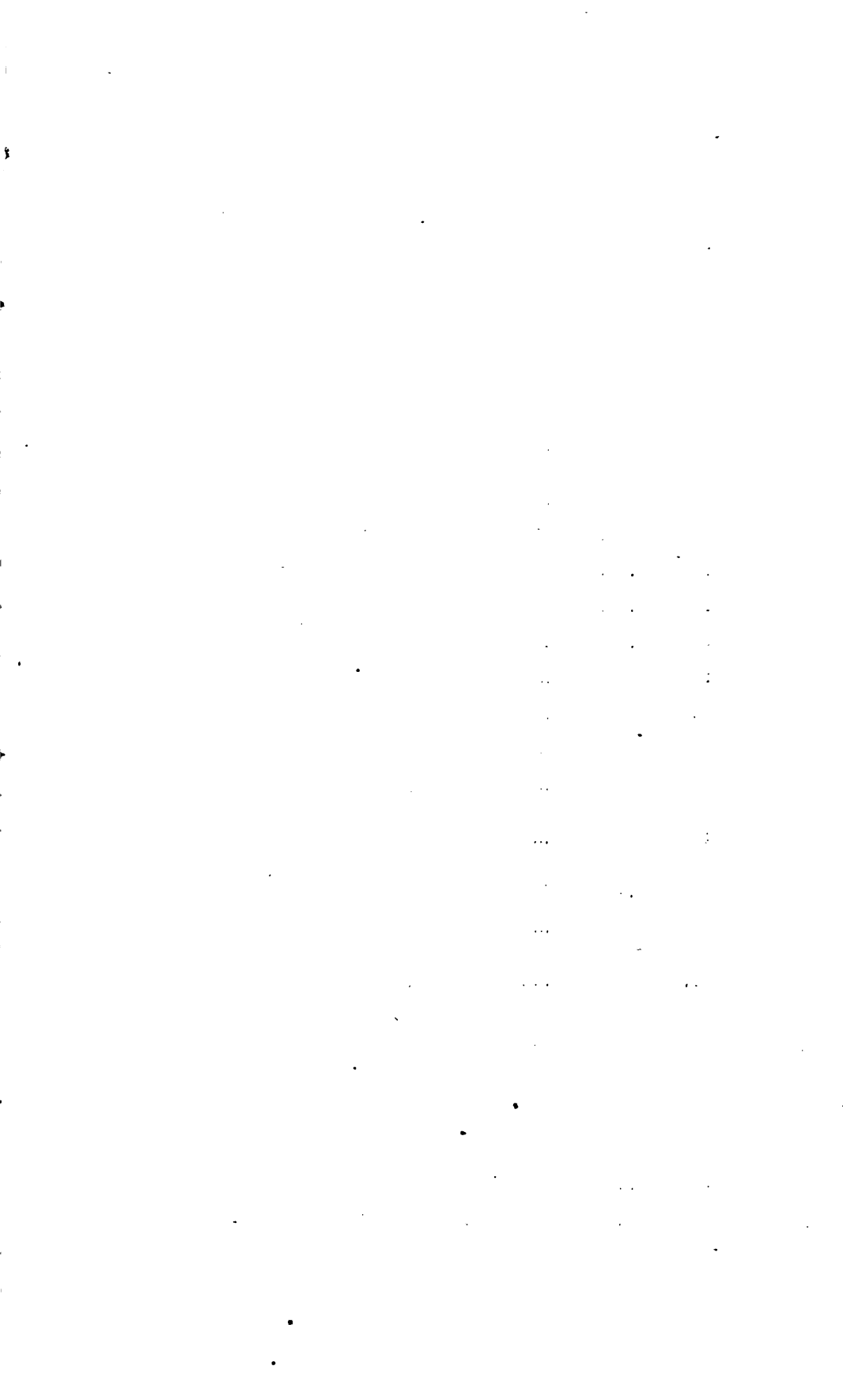

| Page. | Line. | Section. | |
|-------|-----------------|----------|---|
| 248 | | 1050 | For 'नीट <i>bhit</i> ' read 'नीट <i>bhith</i> .' |
| 253 | 5 from bottom. | | For 'गङ्गुष्ठा' read 'गङ्गुष्ठा.' |
| 273 | | | In last column, for 'ससग्नी' read 'ससग्नी.' |
| 274 | 10 from bottom. | | For 'सवात' read 'सावत.' |
| 280 | 16 from bottom. | | For 'वरसे' read 'वरसे.' |
| " | 4 from bottom. | | For 'सामवास' read 'समावस.' |
| 281 | 3 | | For 'neede' read 'need.' |
| 290 | | 1110 | For 'जेर' read 'जेर.' |
| 292 | | 1117 | For 'रककट' read 'करकट.' |
| 299 | | 1147 | For 'उद्वार' read 'उद्वार.' |
| 300 | | 1151 | After 'kās charāi,' add—'काह चराह <i>kāh charāi</i> .' |
| 310 | 13 | | For 'मङ्गुपाटी' read 'मङ्गुपाटी.' |
| " | 15 | | For 'खेन' read 'खेन.' |
| " | 17 | | For 'चोरा' read 'चोरो.' |
| 316 | 10 from bottom. | | For 'टकही <i>takahi</i> ' read 'टकही <i>takhi</i> .' |
| 318 | 12 from bottom. | | For 'केयाली <i>keyāli</i> ' read 'केयाली <i>keāli</i> .' |
| 322 |: | 1200b | After 'rent-free,' add—'or revenue-free.' |
| 323 | 8 from bottom. | | For '1487' read '1482.' |
| 330 | 2 | | For 'money rents are always assessed,' read 'extra money rents are assessed.' |
| 333 | 8 from bottom. | | For 'झाउनी' read 'झाउनि.' |
| 337 | 7 | | For 'सोदया' read 'सोदया.' |
| 357 | 4 from bottom. | | For 'महराह' read 'महराह.' |
| 359 | | 1285 | For 'बरेलि' read 'बरेली.' |
| 360 | | 1288 | For 'बका' read 'बका.' |

| Page | Line. | Section. | |
|-----------|-------------------|----------|--|
| 366 | | 1323 | <i>Add at end of section—'and in West Tirhut लठङ्गर lathangar.'</i> |
| 369 | | 1338 | <i>Add at end of section—'and in West Tirhut खिरखियाणी khirkhiyani.'</i> |
| 372 | | 1349 | <i>Add—'The ceremony of cutting the nails is called in West Tirhut नौह छिल्ली nauh chhilli.'</i> |
| 389 | 4 from bottom. | | <i>For 'दोनी doni' read 'दोनी donni.'</i> |
| 391 | 3 from bottom. | | <i>For 'nagra' read 'nagar.'</i> |
| 412 | | 1461 | <i>For 'धारनिक' read 'धारनिक.'</i> |
| APPENDIX. | | | |
| 2 | | No. 2 | <i>For 'खसारा' read 'खसारा.'</i> |
| „ | | No. 2a | <i>For 'गफराखसारा' read 'गफराखसारा.'</i> |
| 14 | | 14 | <i>For 'am' read 'ām.'</i> |
| | | 15 | <i>For 'बडा' read 'बडा.'</i> |



CONTENTS.

| | PAGE. |
|--|------------|
| DIVISION I.—IMPLEMENTS AND APPLIANCES USED IN AGRICULTURE AND RURAL MANUFACTURES | 1 |
| Subdivision I.—Implements used in preparing land for cultivation | <i>ib.</i> |
| CHAPTER 1.—The plough | 1—5 |
| " 2.—Mattocks and spades | 5—6 |
| " 3.—The harrow | 7—8 |
| " 4.—Rakes used in field work | 8 |
| " 5.—Pickaxes, pitchforks, &c. | 8—9 |
| Subdivision II.—Implements used in sowing, weeding, and irrigation | 9 |
| CHAPTER 1.—Baskets | 9—11 |
| " 2.—Brooms | 11—12 |
| " 3.—Implements used in weeding, &c. | 12—13 |
| " 4.—Implements used in connection with irrigation | <i>ib.</i> |
| Subdivision III.—Appliances used in field-watching | <i>ib.</i> |
| CHAPTER 1.—The sling | 13—14 |
| " 2.—The scarecrow | <i>ib.</i> |
| " 3.—The watchman's platform | 14—15 |
| Subdivision IV.—Implements used in harvesting | 15 |
| CHAPTER 1.—The sickle or reaping-hook | 15—16 |
| " 2.—Rakes used on the threshing-floor | <i>ib.</i> |
| " 3.—Granaries | 16—18 |
| Subdivision V.—Implements and appliances used in connection with cattle | 18 |
| CHAPTER 1.—The fodder-cutter and trough... | 18—19 |
| " 2.—The muzzle and blinkers | 19—20 |
| " 3.—The whip and goad | 20—21 |
| " 4.—Hobbles for cattle | <i>ib.</i> |
| " 5.—Ropes | 21—24 |
| " 6.—Pads for cattle | <i>ib.</i> |
| " 7.—Grain-bags and paniers for loaded cattle... .. | 25 |
| " 8.—Canvas, leather, or tarpaulin covers | <i>ib.</i> |
| " 9.—Vessels from which animals are fed | <i>ib.</i> |
| " 10.—Dairy utensils | 25—27 |
| Subdivision VI.—Appliances used in the conveyance of goods or passengers | <i>ib.</i> |
| CHAPTER 1.—The country cart | 27—28 |
| " 2.—The large, complete country cart | 28—37 |
| " 3.—The light country cart | 37—38 |
| " 4.—The bullock carriage | 38—39 |
| " 5.—The pony carriage | 40—42 |
| " 6.—The country boat | 42—45 |
| " 7.—The litter | 45—46 |
| Subdivision VII.—Appliances used in rural manufacture | 46 |
| CHAPTER 1.—Appliances used in the manufacture of oil | 46—49 |
| " 2.—Appliances used in the manufacture of sugar | 50—60 |

| | PAGE. |
|--|------------|
| CHAPTER 3.—Appliances used in the manufacture of indigo ... | 60—62 |
| " 4.—The spinning-wheel | 62—69 |
| " 5.—The weaver's loom | 69—76 |
| " 6.—The saltpetre manufacture | 76—77 |
| " 7.—A distillery of country liquor | 77—78 |
| Subdivision VIII.—Appliances used by miscellaneous village traders and professionals | 79 |
| CHAPTER 1.—The palm-juice seller | 79—80 |
| " 2.—The bird-catcher | <i>ib.</i> |
| " 3.—The barber | 80—81 |
| " 4.—The country surgeon | <i>ib.</i> |
| " 5.—The farrier | <i>ib.</i> |
| " 6.—The washerman | 81—82 |
| Subdivision IX.—Tools and appliances used by country artizans | 83 |
| CHAPTER 1.—The carpenter and turner | 83—85 |
| " 2.—The blacksmith | 85—88 |
| " 3.—The mason or bricklayer | 88—90 |
| " 4.—The grain-parcher | 90—92 |
| " 5.—The baker | 92—93 |
| " 6.—The confectioner | 93—94 |
| " 7.—The tobacco-manufacturer | 95 |
| " 8.—The pipe-maker | 96—97 |
| " 9.—The pipe-stem maker | <i>ib.</i> |
| " 10.—The cotton-carder | 98 |
| " 11.—The shoe-maker | 98—99 |
| " 12.—The blanket-weaver | 99—100 |
| " 13.—The fancy silk or fringe-maker | 100—101 |
| " 14.—The embroiderer | <i>ib.</i> |
| " 15.—The dyer | 101—102 |
| " 16.—The wood-painter | <i>ib.</i> |
| " 17.—The tinman | 102—103 |
| " 18.—The jeweller | 103—105 |
| " 19.—The lapidary | 105 |
| " 20.—The seal-maker | 106 |
| " 21.—The gold-washer | <i>ib.</i> |
| " 22.—The brazier | 107—108 |
| " 23.—The brass-founder | <i>ib.</i> |
| " 24.—The brass-bangle maker | <i>ib.</i> |
| " 25.—The glass-maker and glass bangle-maker | 108—110 |
| " 26.—The lac bangle-maker | <i>ib.</i> |
| " 27.—The potter | 111—112 |
| " 28.—The firework-maker | 112—114 |
| " 29.—The bookbinder | 114—115 |
| " 30.—The rope-twister | 115—116 |
| " 31.—The weaver's brush-maker | <i>ib.</i> |
| " 32.—The bow-maker | <i>ib.</i> |
| " 33.—The weapon-cleaner | <i>ib.</i> |
| DIVISION II.—DOMESTIC APPLIANCES AND UTENSILS | 117 |
| Subdivision I.—Appliances used in the preparation of food | <i>ib.</i> |
| CHAPTER 1.—Sieves | 117—118 |
| " 2.—The pedal for husking grain | 118—119 |
| " 3.—The pestle and mortar used for husking grain | 119—120 |
| " 4.—The hand grinding-mill | 120—121 |
| " 5.—The grindstone for spices | <i>ib.</i> |
| " 6.—The roller for making paste | <i>ib.</i> |

| | PAGE. |
|--|---------|
| Subdivision II.—Domestic furniture | 120—121 |
| CHAPTER 1.—Stool | 121—122 |
| " 2.—The bed and cot | 122—123 |
| " 3.—The weighing scales | 123—124 |
| " 4.—Nets | 124—126 |
| " 5.—The pad used for supporting water-pots, &c., on a woman's head | ib. |
| " 6.—The stick | 126—127 |
| " 7.—Boxes | 127—128 |
| " 8.—Metal vessels used in cooking and for ordinary domestic purposes | 129—134 |
| " 9.—Earthen vessels | 134—140 |
| " 10.—Wooden vessels | 141 |
| " 11.—Leather vessels | 141—142 |
| " 12.—Leaf platters | ib. |
| " 13.—Stands for vessels | ib. |
| Subdivision III.—Clothes, ornaments, &c. | ib. |
| CHAPTER 1.—Clothes | 142—150 |
| " 2.—Carpets and mats | ib. |
| " 3.—Jewelry... .. | 151—156 |
| Subdivision IV.—Appliances used in worship | 156—157 |
| DIVISION III.—SOILS | 159 |
| CHAPTER 1.—Classification of soils | ib. |
| " 2.—Soils classified according to their distance from the village site | 159—160 |
| " 3.—Soils classified according to their constituent elements | 160—162 |
| " 4.—Soils and water action | ib. |
| " 5.—Muddy and water-logged soils | 162—163 |
| " 6.—High lands and low lands | ib. |
| " 7.—Ravines, mounds, &c. | 163—164 |
| " 8.—Stony soils | ib. |
| " 9.—Cultivated and waste | 165 |
| " 10.—Fallow | 165—166 |
| " 11.—Richness and poorness of soil | ib. |
| " 12.—Irrigated and dry lands | ib. |
| " 13.—Lands which retain and which do not retain moisture | 167 |
| " 14.—Lands bearing a single and a double crop | ib. |
| " 15.—Terms used in connection with different crops | 167—169 |
| " 16.—Land impregnated with salt, &c. | ib. |
| DIVISION IV.—GENERAL AGRICULTURAL OPERATIONS | 171 |
| Subdivision I.—Ploughing and harrowing | ib. |
| CHAPTER 1.—Ploughing and harrowing | 171—174 |
| " 2.—Fields | 174—175 |
| " 3.—Boundaries | 175—176 |
| " 4.—Furrows | ib. |
| " 5.—Miscellaneous terms used in connection with ploughing | 176—177 |
| " 6.—Ploughman and agricultural labourers generally | 177—178 |
| " 7.—Reciprocal assistance in cultivation | 178—179 |
| Subdivision II.—Manuring | ib. |
| CHAPTER 1.—Kinds of manure | 179—180 |
| " 2.—Modes of manuring | ib. |
| " 3.—Manure used as fuel | 180—181 |
| Subdivision III.—Sowing and transplanting | ib. |
| CHAPTER 1.—Sowing | 181—182 |
| " 2.—Modes of sowing | 182—183 |

| | PAGE. |
|--|------------|
| CHAPTER 3.—Seed-beds and nurseries | 184 |
| " 4.—Sowing time | <i>ib.</i> |
| " 5.—Transplanting | <i>ib.</i> |
| Subdivision IV.—Digging, hoeing, and weeding | <i>ib.</i> |
| CHAPTER 1.—Digging | 184—185 |
| " 2.—Hoeing | <i>ib.</i> |
| " 3.—Weeding | 185—186 |
| Subdivision V.—Watching crops | 186—187 |
| " VI.—Reaping and gleanng | <i>ib.</i> |
| CHAPTER 1.—Reaping | 187—188 |
| " 2.—Cutting of unripe crops | <i>ib.</i> |
| " 3.—Gleaning | <i>ib.</i> |
| Subdivision VII.—Threshing and winnowing | 189 |
| CHAPTER 1.—The threshing-floor | <i>ib.</i> |
| " 2.—Sheaves and bundles | 189—191 |
| " 3.—Treading out grain | 191—193 |
| " 4.—Crops on the threshing-floor | 193—195 |
| " 5.—Winnowing | 195—196 |
| " 6.—Miscellaneous | <i>ib.</i> |
| Subdivision VIII.—Division of crops | <i>ib.</i> |
| CHAPTER 1.—Division and valuation | 196—197 |
| " 2.—The shares into which the crop is divided | 197—198 |
| " 3.—Deductions and remissions | 98—199 |
| " 4.—Mode of division | 199—201 |
| Subdivision IX.—Irrigation | <i>ib.</i> |
| CHAPTER 1.—Irrigation generally | <i>ib.</i> |
| " 2.—Kinds of irrigation | 203 |
| " 3.—Irrigation from canals | 203 |
| " 4.— Ditto wells | 203—204 |
| " 5.—Construction of wells | 204—205 |
| " 6.—The lever used in raising water | 206—207 |
| " 7.—The skin bag used for drawing water | <i>ib.</i> |
| " 8.—Other well appliances connected with irrigation | 208—209 |
| " 9.—The pathway for bullocks, &c. | <i>ib.</i> |
| " 10.—The workmen employed at the well | 209—210 |
| " 11.—The Persian wheel | <i>ib.</i> |
| " 12.—Irrigation from tanks and streams | <i>ib.</i> |
| " 13.—Water-lifts and other terms common to irrigation by the swing-basket and the spoon-lever... .. | 211 |
| " 14.—Water-channels | 211—212 |
| DIVISION V.—AGRICULTURAL PRODUCTS AND THEIR ENEMIES | 213 |
| Subdivision I.—Agricultural products | <i>ib.</i> |
| CHAPTER 1.—Wheat | 213—214 |
| " 2.—Mixed crops | 214—215 |
| " 3.—Barley and oats | <i>ib.</i> |
| " 4.—Rice | 215—223 |
| " 5.—Indian corn or maize | 223—224 |
| " 6.—The large millet | 224—225 |
| " 7.—The small bulrush millet | <i>ib.</i> |
| " 8.—The small millets | 225—227 |
| " 9.—Pulses | 227—229 |
| " 10.—Peas | 230 |
| " 11.—Gram | 231—232 |
| " 12.—Sugarcane | 232—237 |
| " 13.—Cotton | 237—239 |



| | Page. |
|--|----------------|
| CHAPTER 14.—Tobacco | 239—241 |
| " 15.—Opium poppy | 241—243 |
| " 16.—Hemp | ib. |
| " 17.—Indigo | 243—244 |
| " 18.—Other dyes | 244—246 |
| " 19.—Oil-seeds | 246—247 |
| " 20.—Fibres | 247—248 |
| " 21.—Betel | 248—249 |
| " 22.—Garden crops | 250—257 |
| Subdivision II.—Insects and causes of injury to crops ... | ib. |
| CHAPTER 1.—Destructive insects and diseases | 257—265 |
| " 2.—Noxious weeds | 265—269 |
| " 3.—Miscellaneous | 269—270 |
| DIVISION VI.—AGRICULTURAL TIMES AND SEASONS | 271—285 |
| DIVISION VII.—CATTLE AND OTHER DOMESTIC ANIMALS | 287 |
| CHAPTER 1.—Cattle generally | ib. |
| " 2.—Bulls | ib. |
| " 3.—Bullocks | 287—291 |
| " 4.—Cows and breeding | 291—292 |
| " 5.—Calves | 292—293 |
| " 6.—Buffaloes | 293—294 |
| " 7.—Goats | ib. |
| " 8.—Sheep | ib. |
| " 9.—Pigs | 294—295 |
| " 10.—Horses, mules, and asses | ib. |
| " 11.—Elephants | 295—296 |
| " 12.—Camels | ib. |
| " 13.—Straying of cattle | ib. |
| " 14.—Colours of cattle | 296—297 |
| " 15.—Hides | ib. |
| " 16.—Cattle slaughter | 297—298 |
| " 17.—Feeding cattle | 298—299 |
| " 18.—Pasturage | ib. |
| " 19.—Fences | 300 |
| " 20.—Grazing-fees | ib. |
| " 21.—Cow-houses and enclosures for cattle, cattle-owners, &c. | 300—301 |
| " 22.—Cattle-dealers | ib. |
| " 23.—Milk and its preparations | 301—303 |
| " 24.—Cattle diseases | 304—306 |
| " 25.—Cattle fodder | 306—311 |
| DIVISION VIII.—LABOUR, ADVANCES, WAGES, AND PERQUISITES | 313 |
| CHAPTER 1.—Pay and advances to labourers | 313—314 |
| " 2.—Advances to tenants | 314—315 |
| " 3.—Dues paid by tenants | 315—320 |
| DIVISION IX.—LAND TENURES | 321 |
| CHAPTER 1.—Tenures | ib. |
| " 2.—Proprietary tenures | 321—323 |
| " 3.—Intermediate tenures | 323—324 |
| " 4.—Shares and sharers | 324—325 |
| " 5.—Cultivating tenures | 325—327 |
| " 6.—Rents | 327—330 |

| | PAGE. |
|--|---------------|
| DIVISION X.—THE NATIVE HOUSE | 391 |
| CHAPTER 1.—The native house | 331—332 |
| " 2.—Parts of a house | 332—338 |
| " 3.—Materials used in the construction of the house | 338—342 |
| DIVISION XI.—FOOD | 343 |
| CHAPTER 1.—Meals | <i>ib.</i> |
| " 2.—Kinds of food | 343—356 |
| DIVISION XII.—CEREMONIES AND SUPERSTI- TIONS OF RURAL LIFE | 367 |
| CHAPTER 1.—Marriage | 367—369 |
| " 2.—Wedding ceremonies generally | 369—362 |
| " 3.—Special wedding ceremonies amongst the Hindus | 362—374 |
| " 4.—Marriage ceremonies amongst the Musalmāns | 374—386 |
| " 5.—Birth customs generally | 386—388 |
| " 6.—Ceremonies peculiar to the birth of a Hindu child | 388—390 |
| " 7.—Birth customs amongst Musalmāns | 390—391 |
| " 8.—Disposal of the dead amongst the Hindus | 391—395 |
| " 9.—Disposal of the dead amongst Musalmāns | 395—396 |
| " 10.—Ceremonies at ploughing and sowing and trans- planting. | 397—398 |
| " 11.—Harvest ceremonies | 398—399 |
| " 12.—Miscellaneous | 399—401 |
| " 13.—Arbitrations, oaths, &c. | 401—402 |
| " 14.—Miscellaneous superstitions | 402—409 |
| DIVISION XIII.—TRADE, MONEY-DEALINGS, AND ACCOUNTS | 411 |
| CHAPTER 1.—Trade and bazār accounts | 411—413 |
| " 2.—Accounts between landlord and tenant | 413—418 |
| " 3.—Interest, discount, and commission | 419—420 |
| " 4.—Rates of interest | 420—421 |
| " 5.—Mortgage | 421—422 |
| " 6.—Miscellaneous | 422—424 |
| DIVISION XIV.—WEIGHTS AND MEASURES | 425 |
| CHAPTER 1.—Measures of length | 425—427 |
| " 2.—Superficial measure | 428 |
| " 3.—Measures of proportion | 428—429 |
| " 4.—Measures of weight | 429—431 |
| APPENDIX | i—xvii |



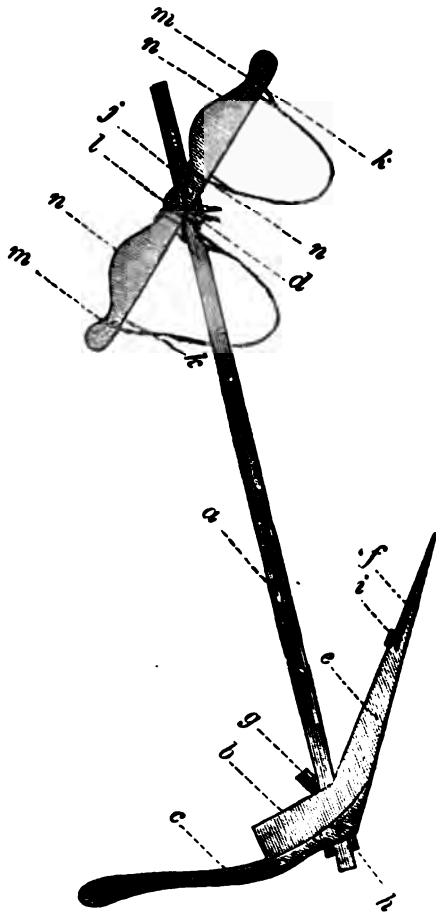

The Country Plough.

(NOTE.—The front portion of the body is given in section, so as to show the position of the share.)

DIVISION I.

IMPLEMENTS AND APPLIANCES

USED IN

AGRICULTURE AND RURAL MANUFACTURES.

SUBDIVISION I.

IMPLEMENTS USED IN PREPARING LAND FOR CULTIVATION.

CHAPTER I.—THE PLOUGH.

1. The ordinary country plough is generally known as **हर** *har*. Sometimes the Hindi form of the word, **हाल** *hal*, is used. In Gaya the word **लंगल** *lāngal* is also used.

2. **खिनौरी** *khinauri* is used for an old or worn plough. In the South-East and in North-West Tirhut this is **थेंथी** *thenthi*, and generally over North-East and South Tirhut **थेंठा** *thentha*. In Shahabad it is **खुतहरा** *khutahra*. A new plough is **नवन्था** *nawtha* or **नौठा** *nautha* to the west, **नवघर** *nawghar* in Champāran, and **लवन्था** *lawtha* generally over North-East and South Tirhut.

3. In West Bihār and South Bhagalpur **सांग** *sānga*, and in South Munger **सांगल** *sāngal*, mean the plough and all its appurtenances, as in the sentence **सांग** (or **हर सांग**) **लेने बाब बहियार** *sānga* (or *har sānga*) *lene āw bahiyār*,—bring the plough, &c., to the field.

4. The various parts of the common plough are as follows:—

5. *The beam* (a).—North of the Ganges this is **हरिस** *haris*, and so also in Shahabad. In East Tirhut it is also called **हरसी** *haris*. In Patna, Gaya, and South Munger it is **सांर** *sānrh*. In South Bhagalpur it is **रिस** *ris*. **हरिस** *haris* is, however, understood more or less everywhere.

6. *The body (b).*—This is everywhere *हर har*.

7. *The handle or stilt (c).*—In Shahabad and north of the Ganges this is *परिवह parihath*; in the eastern portion of the latter tract it is also *लागन lāgan*. *लगना lagnā* is used in South Munger, Patna, and Gaya, and *नांगनो nāngno* in South Bhagalpur. In South-Western Shahabad *परिवह parihat* is used. The knob at the end of the body near the handle is in Patna *चंदवा chandwa*, in Gaya *चाँदी chāndī*, north of the Ganges and in Shahabad *मूठ mūth* (or in the south-west of the district *चंदुली chanduli*), and in the south-east *मुठिया muthiya*. In South Bhagalpur *मकरी makri* is a piece used for mending it when broken. The first, second, and fourth names are only used if it is a separate piece of wood.

8. *The notches on the beam (d)*, by which the share is raised or lowered.—In Sāran *खेड़ा kherha*, in Gaya *खेड़ी khenrhi*, and in Shahabad *खेड़ी kherhi*. In Patna they are *खेड़ा kheha*, in Champāran *खाला khāta*, and throughout Tirhut *खारी khārhi*. In South-East Tirhut it is also *खरखा kharha*, and in South-East Bihār *खौरा khonrha* or *खार खारh*.

9. *The sole (e)*, in which the share is fixed.—

In West Bihār it is *टोर tor* or *टोरा tōra*. In East Bihār it is *नास nās* or *नासा nāsa*.

North of the Ganges the thicker end of the sole is called *नाँच mānth* or *नाँचा mānthā*.

10. *The share (f).*—Everywhere *फार phār*. In North-East Tirhut also *फारा phāra* or *फाला phāla*, and in South-East Tirhut also *लोहामा lohāma*.

11. *The wedge fixing the beam to the body (g).*—North of the Ganges and in Shahabad and South Munger this is *पाट pāt*. Variants are *पटा patta* (Gaya), *पाटा pāta* (South Tirhut and Patna), and *पाटो pāto* (South Bhagalpur).

A second wedge is sometimes added, which is known as *चेही chāhī* everywhere north of the Ganges and in Gaya and the south-west, and also as *चेखनी chelkhi* in South-East Tirhut. In East Tirhut it is also called *चेरी cheri*. Another name is *पाचड़ pāchar* (in North-East Tirhut and Shahabad), or *पचड़ी pachri* everywhere south of the Ganges. In South Bhagalpur it is called *उपर पाटो upar pāto*.

12. *The peg (h)* passing through the shaft at the end, to prevent the body coming off.—This is *बराइन barāin* generally, or *बरेन barāin*

in Champāran and Tirhut; the latter is also used in South Munger. Other forms are, बरेन *baren* in North-East Tirhut, बरहण *barhan* in Sāran, बरेनी *baraini* in Patna, and बरन *baran* in Shahabad. Other names are सब धरिया *sabh dhariya*, सत धरिया *sat dhariya*, in Patna, and सबधर *sabhdhar* in Gaya, because it holds the whole plough together. Also तरेल *taraila* in South Bhagalpur, तरेली *taraili* in South-West Shahabad, and हम्मना *humna* in Patna.*

13. *The iron clamp (i)* for preventing the share falling off.— करुआर *karuār* or करुआरा *karuāra* everywhere to the west. A variant is करुआरी *karuāri* (Patna, Champāran, and West Tirhut). In South-West Shahabad it is also called खुरा *khūra*. In Patna it is also called जोका *jonka*, and the same name is current all over Bihār. जोकी *jonki* and चोबी *chobhi* are also used in South-East Tirhut. In North-East Tirhut a wedge is also used for the same purpose, and is called गासी *gāsi*.

14. *The yoke*.—North of the Ganges always पादो *pālo*; so also in Patna, Gaya, and South Munger, with a variant पाळ *pāla* in South Bhagalpur. In Shahabad and Gaya the word is generally जुआठ *juāth*, which is also sometimes used in Sāran and the east. Sometimes it is made up of two bars. The upper bar then is considered the yoke proper, and is hence usually called the जुआठ *juāth*. The lower bar is generally तरंगेला *tarsaila*.

This double-bar arrangement is not commonly found in the plough yoke. It is more usually met with in the yoke for well irrigation (मोट *mot*); so also the two following pins. As a general rule पादो *pālo* or जुआठ *juāth* (according to locality) may be safely used for the single-bar plough-yoke and for the double-bar irrigation yoke, and जूआ *jūa* for the single-bar cart-yoke. See § 938.

15. *The outer pins*, which join the two bars of the yoke, are सेला *saila* or समेल *samail* to the west and कनेल *kanail* to the east. They are also कनकिल्ली *kankilli* in South Bhagalpur.

16. *The inner pins* are समेल *samail* or (Patna and the south-east) समेला *samaila* and (Gaya) समैया *samaiya*.

17. *The leather thongs (j)*, which attach the yoke to the beam of the plough.—These are from Patna to the east of the South Gangetic tract, and in Champāran, नारन *nāran*, with a variant लरनी *larni* in

* About हम्मना *humna* there is a story of a Jolha (the proverbial fool of Bihār stories) who found a *humna* on the road and cried out in his foolishness पासी हर के हम्मना, खेतोकरव बनाय *pāsi har ke humna, kheti karav banāy*,—I have found the rear peg of a plough, I'll turn a farmer at once.

North-West and South-East Tirhut, and optionally लारन *lāran* in South-East Bihār. नाथा *nādha* and नरेली *naraili* are used in Shahabad, and variants of the former word occur in लरणा *ladha* (South-East Tirhut), लेथा *leidha* or लाथा *lādha* (North-East Tirhut), and हर लथी *har ladhi* or हर नाथा *har nādha* over South Tirhut generally. नाथा *nādha* is also used in Gaya. हर ना था *har nādha* in Sāran is only used when they are of string. When they are of leather, in that district they are called दुवाली *duālī*. South Bhagalpur has डोंडा *donra* or लेथा *ledha*.

18. *The ropes (k)* which go round the bullocks' necks.—These are everywhere except in the extreme west जोती *jōti*. In the extreme west (Sāran, Champāran, and Western Shahabad) the masculine form, जोता *jōta*, is the usual one. In North-East Tirhut they are also सनेल *samel* or सनेल *samil*, and in South Bhagalpur डॉंस *phānsa*.

19. *The projecting knob (l)* in the middle of the upper part of the yoke.—Round this the thongs which fasten the yoke to the beam are fixed. This is everywhere महादेवा *mahādeva*. Variants are महादेवो *mahādeo* (Patna and Gaya) and महदवा *mahdava* (South Munger). In South Bhagalpur it is मंजवार *manjwāra*.

20. *The notches (m)* near each end of the yoke.—To these the ropes which go round the bullocks' necks are fixed. These are खँड़ी *khānri* in Patna, with variants खड़ी *khārhi* in South-East Tirhut and खेड़ी *kherhi* to the west. South-West Shahabad has खड़ी *khaddhi*. In Gaya the word used is कनौची *kanausi*, and in South Bhagalpur खात *khāta*, while सिमल *simal* or नकटी *nakti* are optional names in South-East Tirhut.

21. *The leaf of the yoke (n)*.—This is पत्ता *patta*, पला *palla*, or (in South Munger) पलर *palai* and (in Sāran) पाता *pāta*.

22. *The trough* in which the share lies when fixed in the body is खोल *khol*, or in South Bhagalpur खोली *khōli*.

23. *The bamboo whip* with which the bullocks are driven is पेना *paina*, and its lash is चिटि *chhiti* in North-East Tirhut. Other names will be found in § 98 and ff.

24. *A drill plough*.—This is generally टार *tār*, with variants in South-East Tirhut टॉरी *tānri* and टोर *tor* in South Munger. The share is टारसू *tarsū*. खिला *khilla* is the nail which fastens the share to the body. The bamboo pipe is in West Bihār बॉसा *bānsa*, also sometimes बन्सा *bansa* in Shahabad. In East Bihār this is generally चोंगा *chonga*, except in South Munger, where it is हर चॉड़ी *har chānri*.

The cup at the top, into which the grain is poured, is in West Bihār माला *māla* or महवा *mahwa*. In East Bihār it is पैला *paila* (sometimes spelt परला *paila* or पाइला *paēla*) or माली *mālī*. In South Munger it is also उखरी *ukhri*, and in Patna अकरी *akri*.

25. *The sharpening of a ploughshare is called as follows in the various districts:—*

Shahabad: धार पिटावल *dhār pitāval*; or in the south west of the district धार फरगावल *dhār phargāwal*.

Patna: धार असराय *dhār asrāēb*.

Gaya: असार *asār*.

South Munger and South Bhagalpur: धार पजाव *dhār pajāv* or असार *asār*.

North of the Ganges generally: धार पिटावल *dhār pitāwal*.

Also, North-West Tirhut and Sāran: धार पिजावल *dhār pijāwal*.

North-East Tirhut: धार बनाव *dhār banāēb*.

South-East Tirhut: धार करा काय *phār kerā lāēb*.

26. When a man wishes to *plough deep* he harnesses the yoke higher up the beam in the notches (*d*). This is called in West Bihār औगार *augār*. In North-West Tirhut it is called लगार *lagār*, and in the rest of Tirhut तराख *tarakh*. In South-West Shahabad it is called अवाइ *awāē*, in South Munger ठाहा *thārha*, and in South Bhagalpur ठाह *thārkh*. Light ploughing is done in the converse way, and is known everywhere as सेव *sev*, or in North-East Tirhut सेब *seb*.

CHAPTER II.—MATTOCKS AND SPADES.

27. A large mattock is in West Bihār and Gaya फौरा *phaura*. Variants are फहोड़ा *phahora* (Patna and Gaya), फहोरा *phahora* (South Munger), फहोरा *phaōra* (Patna and Gaya), and फहरा *phahura* or फरहा *pharaha* in Shahabad. In South-West Shahabad it is फरसा *pharsa*. In Tirhut it is कुदर *kudār*, and in South Bhagalpur and South Mungēr कोदर *kodār*. Another name current in Gaya is जाम *jhām* or जामा *jhāma*. In the same district आभी *abhi* is a heavy kind of wooden spade tipped with iron for hard soils, and खुरनी *khurni* or खुदनी *khudni* is a kind of spade.

28. A mattock with a narrower blade is कुदारी *kudāri*, कोदारि *kodāri*, or कोदारी *kodāri*. South of the Ganges it is also कुदाली *kudālī*.

कुदाळ *kudāl* and कुदार *kudār* are often used to signify also the smaller variety. In South Bhagalpur it is ठेंडी कोदार *thenthi kodār*.

29. The handle is बेंट *bent*, and the upper end of it, which projects beyond the socket, हूरा *hūra* or हूर *hūr*, or (in South-West Tirhut) मुठा *mūtha*. Other names for this end are एड़ा *era* or अड़ानी *ārāni*, and in South Bhagalpur पाटा *pāta*. The ring or socket in the blade, to which the handle is fixed, is पास *pās* or पासा *pāsa* (or in South Bhagalpur पासो *pāso*). In South-West Shahabad it is पंवारो *pamwānri*, and in South Munger (optionally) पसाटा *pasāta*. The curved part of the blade is in Sāran and Patna फरी *phari*. Elsewhere, north of the Ganges and in South Munger, फरकी *pharki*. In Patna and South Munger it is also called फल *phal*, in South Bhagalpur फरो *pharo*, and in Gaya फारी *phāri*. In Shahabad it is धार *dhār*, and in the south-west of the district दम्प *damp*. The place where the ring and the blade meet is कन्धी *kanthi* in Patna and Gaya; नहिन *nahin* in Shahabad, सन *san* or कन्ध *kanth* in South Bhagalpur, and सन *sun* in South Munger. In Sāran the part of the handle which is grasped is मुठ *mūth*, and the corners काना *kāna*. A new mattock is नवघर *naughar*, and a worn one ठेंडी *thenthi*.

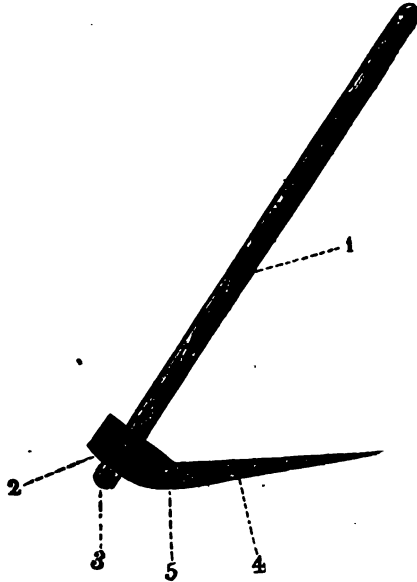

1. *Bent* (handle).
2. *Pāsa* (socket).
3. *Hūra*.

4. *Phari* (blade).
5. *Kanthi* (neck).

The Mattock (Phaura or Kodār).

CHAPTER III.—THE HARROW.

30. This is usually the *flat plank*, with (in the east) a grove along the underside. It is dragged along the ground to break the clods after ploughing, while a man stands on it to give weight. In West Bihār and in South-East Tirhut it is called हेंगा *henga*, and in East Bihār more usually चौकी *chaunki* or चौकी *chauki*. In Patna it is also called सिलवे *silve*, पटवे *patwe*, or लगवरी *lagāwri*.

31. When drawn by one pair of oxen—one ox at each end—it is called हेंगी *hengi* in Champāran, दुगोड़ी *dugori* in Tirhut, एक हारा *ek hara* in South Bhagalpur, and दोबरन्दा *dobarda* elsewhere. When drawn by two pair of oxen—one pair at each end—it is called in North-East Tirhut चौगोड़ा *chaugora*, in the rest of Tirhut चरगोरी *chargori*, दो हारा *do hara* in South Bhagalpur, and elsewhere चौबरन्दा *chaubarāda*.

32. The pegs to which the hauling ropes are fastened are generally खूँटी *khūnti*. In Shahabad they are also called संरु *sanrusa*, and in the south-west of the district गुली *gulli*. In Gaya they are बाँका *baunkha*, in Patna and South Munger बहखा *bahkha*, and in South Bhagalpur अंकोरा *ankora*.

33. The hauling ropes are, north of the Ganges generally, and in West Shahabad, बरही *barhi*. North of the Ganges they are also हेंगही *hengahi*. In Shahabad chains used for the purpose are सींकर *sinkar*, and in Patna and Gaya सीकर *sikar* when used with four bullocks abreast. These words are also used in North Tirhut. In Patna they are also चौक नारन *chauk nāran* when of rope. In South-East Tirhut they are also called मरिखर *marikhar*, and in South Bhagalpur जगदोरी *jagdori*. In South Munger they are सीकर *sikar* when made of chain, and मरिखर *marikhar* when made of rope, and मजौतर *majhautar* is the rope or leather strap joining the two yokes when four bullocks are used. So also in Patna and Gaya. The last word is मजौतर *majhotar* in East Tirhut. In East Tirhut, when made of leather they are called मैरन *mairan* or मेहन *merhan*, and when made of rope बरन्दा *barha* or बरही *barhi*. Sometimes long strips of bamboo are made to serve as hauling ropes. They are then called in South Munger कुदंडी *kudandī*, in South Bhagalpur बसजोती *bansjoti*, and elsewhere चरीचा *arāua*.

34. The channel in the lower part of the plank to break the clods is in South Bhagalpur बघरी *ghaghri* or चार *ghāi*, in South Munger खदधा *khadha*, and elsewhere खड्डा *khaddha*. The channel is generally the

hollow of the stem of the talipot palm, the harrow being composed of the split half of a log of that tree.



1. *Henga* (harrow). 2. *Khānti* (pegs). 3. *Barki* (ropes).

The Harrow (Henga or Chauki).

35. The *cylindrical roller* is rarely used in the field. It is called everywhere by a corruption of its English name, viz. रोल *rol*. The block itself is called पत्ता *palla* (Patna), लकड़ी *lari* (Gaya), एकठा *ektha* in Shahabad, and लकड़ी *lakri* in South-West Shahabad. Elsewhere it is simply चौकी *chaunki* or चौकी *chauki*.

36. Sometimes the harrow is made of two parallel planks joined together. This is called हेंगा *henga* or चौकी *chauki*, &c., as above.

CHAPTER IV.—RAKES USED IN FIELD WORK.

37. Rakes are seldom used. Sometimes a bundle of thorns is dragged over a field to soften the surface when it has been baked hard by the sun after rain or irrigation. This has no special name. In parts of Tirhut the कन्टा *kanta* or खखोरनी *khakhorni* is a sort of rake or harrow worked by oxen to loosen the soil and extricate weeds from a crop of young rice. A पचपरिया *pachphariya* or (in Sāran) गेलनी *gelni* is a kind of plough with five shares used in indigo factories.

CHAPTER V.—PICKAXES, PITCHFORKS, &c.

38. *A pickaxe*.—North of the Ganges this is गैता *gainta*, south of the Ganges it is गैता *gainta* or गैती *gainti*. In South Bhagalpur it is गैचा *gaincha*, and in South Munger गता *gāta*.

39. The *dredger*, used in well-sinking, has various names. In Shahabad, Sāran, and South Tirhut it is चालना *chalna*, and in Champāran



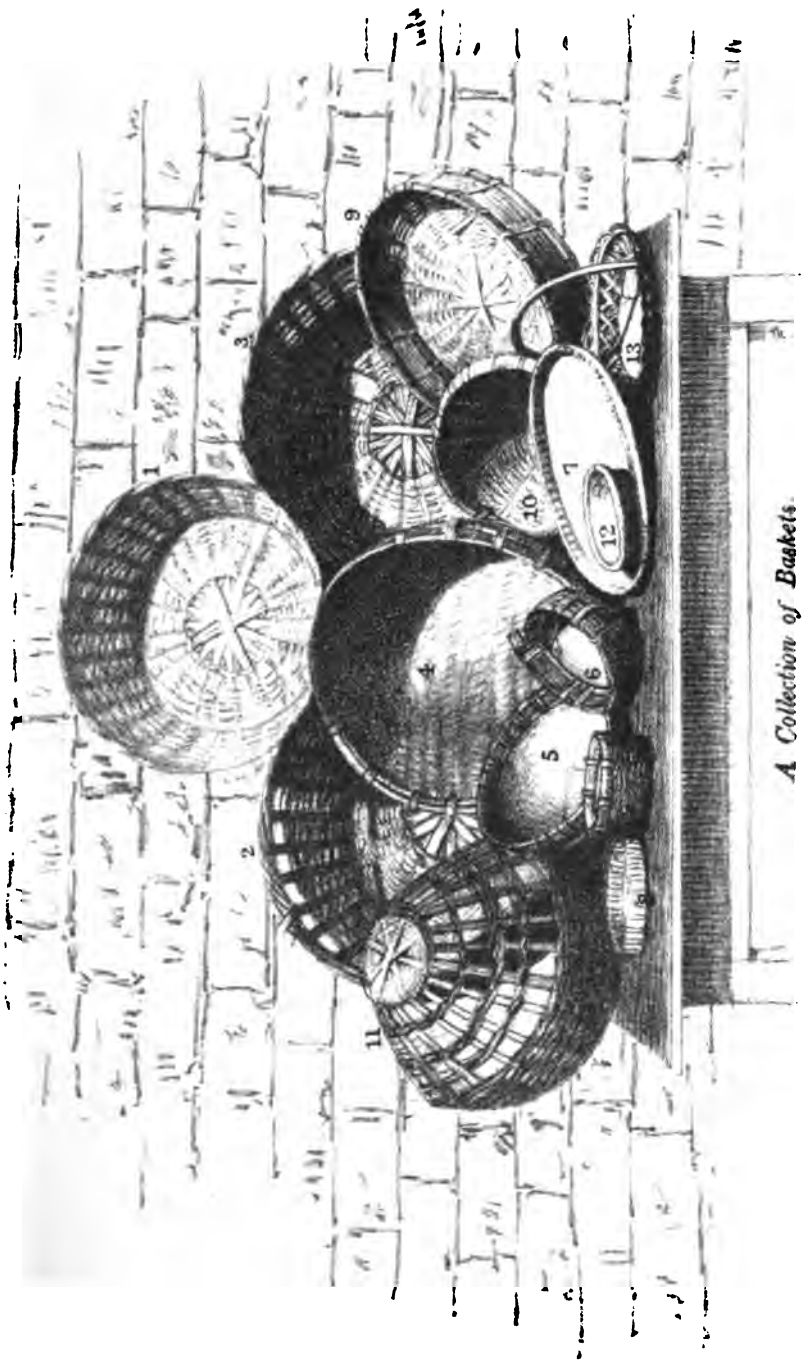

A Collection of Baskets.

- | | | | |
|--------------|--|--------------|--|
| 1. Chhainta. | made of split bamboo. | 8. Dagri, | made of split bamboo, edge sewn with tal leaves. |
| 2. Ditto | " ditto, woven up with tal fibre. | 9. Dais | " split bamboo. |
| 3. Oriya | " split bamboo. | 10. Tokri | " tal slips and bamboo. |
| 4. Daura | " ditto. | 11. Tap | " bamboo slips. |
| 5. Dauri | " ditto, strengthened with tal leaves. | 12. Sitabuti | " munj grass. |
| 6. Two ditto | " split bamboo. | 13. Phuldali | " flower-basket |
| 7. Dagra | " ditto, edge sewn with rattan. | | |

तरहकी *tarchhi*. In North-East Tirhut it is चौडी *chhiti*, कहुली *kathuli*, or पथिया *pathiya*. चौडी *chhiti* is also used in South-East Tirhut, where also occur कडवत *kathwat* and (also in Shahabad) तगाड़ी *tagāri*. Elsewhere south of the Ganges it is गैता *gainta* or खन्ती *khanti*, and in South Munger चौडा *chhita*.

40. The *pointed iron spear* for tapping the well-spring also has various names, viz. खुटा *khunta* north of the Ganges generally, गजाड़ा *gajāra* in Sāran, and गोभनी *gobhni* in South-West Tirhut. In Gaya it is खोभना *khobhna*, and in Shahabad खोभन *khobhan*, but in the south-west of the latter district it is लरहा *larha*. In South Munger it is देभन *debhan*, and in South Bhagalpur it is गजाड़ा *gajāra* or खन्ती *khanti*.

41. The *hooked stick* for pulling down fruit from trees is generally लग्गा *lagga* or लग्गी *laggi*. The hook of this is अंकुसी *ankusi* or (in South Bhagalpur) कानी *kāni*. The long pole with a small net at the end to catch the fruit as it falls is जोडा *jhola*, खोंची *khonchi*, or (in Sāran) जोरा *jhora*. Another optional name in South Munger is जलखारी *jalkhari*.

The short stick thrown up into fruit-trees to bring down fruit is जलथा *jhatha*, and also (in Sāran) लगुसी *lagūsi*.

SUBDIVISION II.

IMPLEMENTS USED IN SOWING, WEEDING, AND IRRIGATION.

CHAPTER I.—BASKETS.

42. Baskets are generally woven of bamboo slips or twigs. Unless otherwise stated, this may be assumed of all the following.

43. Baskets used specially by the sower are called generally ओड़ा *ora*, ओड़ी *ori*, or ओड़िया *oriya* (sometimes made partly with the fibre of the leaves of the tāl palm); also we meet, to the west, छैडी *chhainti*, and to the east चौडा *chhita* (a large one), चौडी *chhiti* (a small one), or दौरी *dauri*. South of the Ganges they are also called in Patna बट्टा *battā*, (also in Shahabad) दौरा *daura*, or दौरी *dauri* (sometimes made of the culm of the *sik* grass, *andropogon muricatum*), in Gaya (also in North-

East Tirhut) पथिया *pathiya* (also used for feeding cattle), and in South Munger खंचिया *khanchiya*. The only difference amongst all these is that in the case of the दौरा *daura* and दौरी *dauri* the bottom is woven of bamboo slips, like a mat.

44. There are likewise several other kinds of baskets, used indiscriminately for this and other domestic and agricultural purposes. Thus, small straw grain-baskets are चंगेली *changeli* or चंगेरी *changeri*, and sometimes दाली *dali* or दलिया *daliya*, especially towards the east. In Patna and South Munger they are called बटरी *batri*. Another very similar basket (but still smaller) is called very generally मौनी *maunni* or मौनिया *mauniya*, also बट्टा *batta* in Patna, Gaya, and South Munger, and फुलुकी *phuluki* in East Tirhut. A large open basket made of split twigs of bamboo generally woven up with the fibre of the leaves of the tál palm is called टोकड़ा *tokra*, धाका *dhāka*, धाकी *dhāki*, चोड़ा *ora*, or चैंटा *chainta*. A smaller variety is called गंजा *ganja*, टोकड़ी *tokri*, धाकिया *dhakiya*. When the bottom is very finely woven, so as even to hold water, it is called चोड़िया *oraissa*. The धामा *dhāma* is an open basket made of rattan. The खैंचा *khaincha* or खैंचा *khāncha* is a large coarse basket made of twigs of *cytiscus cajan* (*rahar*) or tamarisk (*jhāū*). South of the Ganges we also find देही *deli*. A smaller basket of the same kind is known as खैंची *khānchi* (also खैंची *khānji* in North-East Tirhut), खंचिया *khanchiya*, खचोली *khacholi*, पथुली *pathuli* (Gaya), नोनीचारी *nonihāri* (Patna), or (South Bhagalpur) दमहरिया *damhariya*. The दगगा *dagra*, दगरी *dagri*, also called south of the Ganges दौरा *daura*, दौरी *dauri*, or (in South Bhagalpur) दाला *dāla*, is a large shallow basket. These are all made of either bamboo twigs or slips, except the दौरा *daura* or दौरी *dauri* (see above). In Shahabad कररु *karūi* or डोकी *doki*, and north of the Ganges सिकहुती *sikahuti* or सिकौती *sikauti*, is a little basket made of the stalks of the *mūnj* grass.

45. A broken basket is चितनी *chhitni*, or in Gaya चतना *chhatna*, or in South Bhagalpur चितनी *chhitni*.* The जंपी *jhampi* or जंपिया *jhampiya* is a little basket with a lid. It is also called पौती *pauti* or पौतिया *pautiya* (being then generally made of *mūnj* grass) and पेटारी *petari* (made of bamboo or rattan). A larger kind is called जंपा *jhāmpa*. The lid of all these is called पेहानी *pehāni* or जंप *jhāmp*. डैचा *thaicha* or चंगोर *changor*, or in Shahabad डैचा *thaincha* or डौचा *thīncha*, is a kind of large open basket. फुलदाली *phuldāli* is a flower-basket.

* A common curse amongst Gaya women is चितनी बदनो जागो *chhitni barhni lāgau*,—may your wealth be swept away.

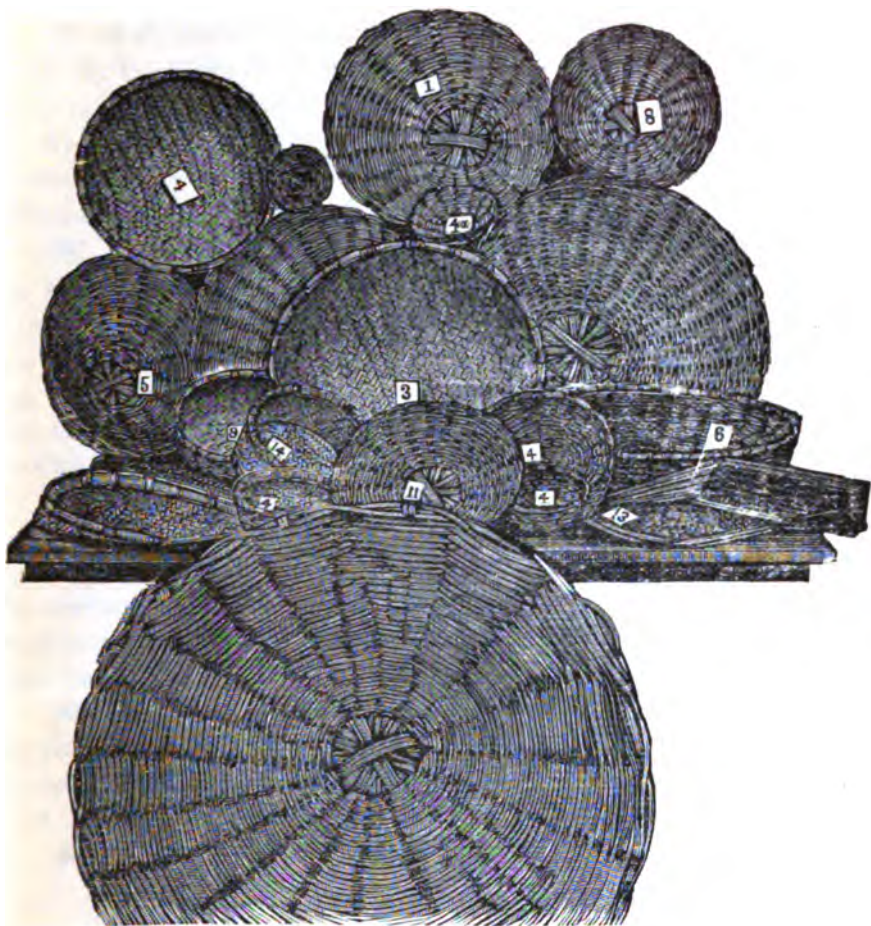

From a photograph.

A Collection of Baskets and of Other Articles of Basket-work.

1. Oriya.
2. Chhaintas of various sizes.
3. Daura.
- 4 & 4a. Dauris of various sizes.
5. Deli.
6. Khaincha.
7. Tāp.
8. Tokri.
9. Dagri.
10. Dagra.
11. Tarāju (scale-pan).
12. Kolsup. } (Winnowing sieves).
13. Sūp. }
14. Chalni (sifting sieves).

MATERIALS.

Nos. 1 and 8 are made of split bamboo twigs, woven up with the fibre of the leaves of the tāl palm.
 4a, of the culm of the *sik* grass (*andropogon muricatum*).
 5 & 6, of tamarisk (jhāū).
 7, of *rahar* (*cytisus cajan*).
 11, of bamboo twigs.
 13, of *sirki* (the upper joint of *saccharum procerum*).
 The rest are of bamboo slips.



बाजी *saji* is one with a handle. In North-East Tirhut बडोर *mator* is a basket used by betel-growers (बररै *barai*).

46. डेली *deli* is the basket employed by coolies when working on roads. In the North-Western Provinces the same word is used for a basket in which wild fowl, fish, or young pigs are kept.

47. A winnowing-basket or sieve is कोलसूप *kolsup*, or in North-West Tirhut दगन्ना *dagra*. A basket for sifting grains of various sizes is सूप *sap*. A scale-pan is तराजू *tarāju* or तरजूरी *tarjūri*.

48. There are several kinds of baskets used for catching fish, viz. टाप *tāp*, टापा *tāpa*, टापी *tāpi*; गंज *ganj* or गंजा *ganja*; सरैला *saraila* (Tirhut); अन्ता *anta* in East Tirhut; परन्ने *parwe* or चारन्ची *ārsi* in Patna; चरन्ची *arsi*, पेरन्ना *perwa*, or सैरा *saira* in South Bhagalpur; and चोपा *chhopa* in Shahabad. The last is also worn over the head and down the back in the rainy season to keep the wearer dry, and is called in Sāran चोपी *chhopi*.

49. South of the Ganges बींकी *bhaunki* is a large basket with a narrow mouth. तरौना *tarauna* in Gaya is a basket made of tamarisk for carrying refuse, and in Patna बोगिया *bogiya* is a small basket for cowdung. In South-East Tirhut चांग *chāng* is a large basket equal to four टोकरी *tokri* for carrying chaff. टंगौर *tangaur* is a similar kind, but made of *rahar*, and rougher.

50. In Sāran तरन्ना *tarchha* is a basket used in weeding poppies. टाप *tāp*, टापा *tāpa*, or टापी *tāpi*, or (in South-East Tirhut) खोप *khomp*, and in Sāran काँप *jhāmp*, is a basket under which chickens are kept. These are generally made of *rahar* (*cytisis cajan*).

51. बत्ती *batti* or बानी *bati* are the twigs used for weaving baskets.

CHAPTER II.—BROOMS.

52. These are used for various agricultural and domestic purposes.

53. The ordinary sweeper's broom is झाड़ू *jhāru* and झाड़ुआ *jhārūa* or जड़ुआ *jarūa*. In South-West Shahabad it is also called सेथन *sethan*, and near Ara कुँचा *kuncha*. South of the Ganges, to the east, it is called बोहन *borhan* or बोहनी *borhni*.

54. The broom used by women in sweeping out the house and also by sweepers is बरहनी *barhni*, or in North-East Tirhut also बरहन *bārhan* or बरहनि *bārhani*. According to Crooke it is so called because the family is supposed to prosper (*barhnā*). It is also called towards the west कुँची *kunchi*.

55. The broom used for sweeping up the grain on the threshing-floor has various names. North of the Ganges, in Sāran, it is बिरन्ना

sirhath, and in North-West Tirhut *सरहथ sarhath*. In Champāran it is *खरहरा kharhara*, and in the rest of Tirhut *खरै kharra*. South of the Ganges it is, in Gaya and South Munger, *कुचा kuchcha*, in Shahabad *कुंचा kūncha*, and in the south-west of the district *कुची kunchi* or *सेथन sethan*. In South Bhagalpur it is *जटरी jhatai* or *खरहरा kharhara*.

56. The broom used by grain-paroehers for turning the grain which is being parched is *आरु jhāru* in Patna and Gaya, *बहनी barhni* in the south and east generally, *खरना larna* in North-East Tirhut, *चिपनी chhipni* in South-East Tirhut, *चलौनी chalauni* to the west of the North Gangetic tract, and in South-East Bihār *भुजनाठी bhujnāthi*.

57. The long twig broom used for sweeping up leaves and rubbish is north of the Ganges, to the west, *खरहरा kharhara*, and to the east *खरै kharra*. South of the Ganges, in South Bhagalpur, it is *खरहरो kharharo*; but in Patna *आँटा jhānta*, in Gaya *आरु jhāru*, in Shahabad *सिरहत sirhat* or *आँची jhānki*, in the south-west of the same district *खरना jharna*, and in South Munger *आँटा jhānta* or *जटैनी jhataini*.

58. To sweep is in Patna and Gaya *बोहारब bohārab* or *बाहब bārhab*; the former is also used in the south-east. To the west it is *बहारब bahāral*, and in Tirhut *बाहब bārhub*, *आरब jhārab*, or *आरि खुरि देब jhāri jhuri deb*.

CHAPTER III.—IMPLEMENTS USED IN WEEDING, &c.

59. The *खुरपा khurpa* is a sort of hoe used for loosening the earth round young plants or in weeding.

60. Of this the iron blade is *खुरपा khurpa*, or in North-East Tirhut *पासङ्ग pāsāng*. The handle is *बेंड bent*. The iron ring-fastening in the blade is *साम sām* or *सामी sāmi*, and also in Shahabad *चुरिया churiya*, and in the south-west of the district *मुंदरी mundri*. The spike of the blade which goes into the handle is north of the Ganges *नार nār*, and south of it *नार nār* or *डन्डी danti* or (South-West Shahabad) *दाँड़ी dānri*. Towards the east we find, north of the Ganges, an optional variant *लार lār*, and in South Bhagalpur *लारु lāru*.

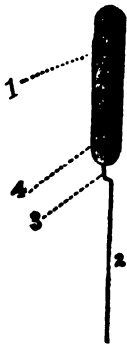

1. *Bent* (handle).
2. *Khurpa* or *khurpi* (blade).
3. *Nār* or *dānri* (spike).
4. *Sām* (ferule).

The Hoe (Khurpa or Khurpi).

61. A smaller instrument for scraping grass or weeding is called,

when the blade is curved, खुरपी *khurpi*, and (south of the Ganges) when it is straight पसनी *passni*. An optional name for the curved variety in Gaya is बँडुषा *bankua*.

CHAPTER IV.—IMPLEMENTS USED IN CONNECTION WITH IRRIGATION.

62. The beds formed in a field for irrigation are called किवारी *kiyāri*. In South Bhagalpur they are called केवारी *keāri*. In South Munger गँवारी *ganrāri* are smaller sized beds for the same purpose.

63. These are made with an implement with a handle and board fixed at the bottom, like a rake without teeth. This is worked by a single man, much as a rake is used. In the North-Western Provinces it is usually pulled with a rope, but not so usually in Bihār. It is called generally to the south of the Ganges फरुही *pharuhi*, and in East Tirhut फरुहा *pharuha*. North of the Ganges, to the west, it is called फहुरी *phahuri*. In South Bhagalpur it is called फरुषा *pharua*, and in South Munger फरुही *pharhi*. In Gaya it is called पँडुनी *penrni*.

64. A wooden shovel used in distributing the water in a field is called हथा *hatha* or हत्था *hattha*. South of the Ganges it is also called आभा *ābha*, in South Bhagalpur चिहा *chhitta*, and in South Munger कठौषा *kathaua*.

65. Other appliances used in connection with irrigation from wells, tanks, or streams will be found in the chapter on irrigation.

SUBDIVISION III.

APPLIANCES USED IN FIELD WATCHING.

CHAPTER I.—THE SLING.

66. This is generally डेहन्नास *dhelmās* or डेहन्वाँस *dhelwāns*. In Patna, Gaya, and (optionally) Shahabad it is also called डँकन्वाँस *dhenkwāns*. Another name current in Shahabad is डेकुषास *dhekuās*.

In South-East Tirhut it is also called डेलौरी *dhelauri*. In South Munger and South Bhagalpur it is दिंदोर *dinror*. गुरदेल *gurdel* or, to the east, गुलेती *guleti* is a pellet-bow.

CHAPTER II.—THE SCARECROW.

67. This is generally धूह *dhāh*, धूहा *dhāha*, or धुवा *dhua*. In Patna it is पुनखा *putla*, and in Gaya धही *dhahi*.

68. A scarecrow pulled by a string and hung on a tree is north of the Ganges धबद्धबवा *dhabdhabwa*, ठकरा *thakra* to the west, धकधकिया *dhakdhakiya* in South-West Tirhut, अकासी *akāsi* in South-East Tirhut, and elsewhere तारक चजा *tārak chhaja* or धुवा *dhua*. South of the Ganges it is in South-West Shahabad दमहौवा *damhaua*, elsewhere in the district दमको *damko*. In Patna it is दमकौवा *damkaua*, and in Gaya धककौवा *dhalkaua*. In South Bhagalpur and South Munger it is हरका or हकका *harka*.

69. Cultivators also usually put an old black earthen pot in a field to keep off the evil eye, which is called in Tirhut डोटका *totka*, or in North-East Tirhut तौका *taula*. South of the Ganges we find also डोटका *totka*, with variants डोटना *totma* (Gaya) and डोटवाँ *totwān* (South Bhagalpur). In Shahabad it is called टोना *tona* or नजर गोजर *najar gojar*, and in South Munger नजर गुजर *najar gujar*. Another general name is करिहार हाँकी *karikhāi hānri* or करखादि हँकिवा *karkhāhi hanriya*, from करिवा *karikha* or करखा *karkha*, 'soot.' Local variants of this last word are करखी *karkhi* (Shahabad), कारिख *kārikh* (Gaya), and करखो *karkho* (South Bhagalpur). Generally this pot is marked with lime (चूना *chūna*). Thus, a man of Ara would say हँकिवा में करिवा लगा के चुन्ना के ठीक दे के खेत में घै बावस जावा *hanriya men karikha laga ke chunna ke tik de ke khet men dhai āwal jāla*,—he has come back after setting up in the field the pot on which he has laid soot and marks of lime.

CHAPTER III.—THE WATCHMAN'S PLATFORM.

70. This is known as मचान *machān*, with an optional variant मँच *mānch* in the west.

71. The shed over the platform has various names, viz. north of the Ganges **झोंपड़ी** *jhompri* and **खोंपड़ी** *khompri* generally, **चपन्नी** *chhapri* (North-West Tirhut), **चाही** *chhāhi* (North-East Tirhut), and **लगौरी** *lagauri* (South-East Tirhut). South of the Ganges we have **चपन्ना** *chhapra* to the west and **मरुका** *maruka* and **चपन्नी** *chhapri* to the east.

72. **मरुई** *marai* and also (in East Tirhut) **मर्रा** *marra*, **गोहिवा** *gohiya* (South-West Tirhut) and **पलानी** *palāni*, is a shed on the ground without any platform.

SUBDIVISION IV.

IMPLEMENTS USED IN HARVESTING.

CHAPTER I.—THE SICKLE OR REAPING-HOOK.

These are either toothed or with a sharp cutting edge.

73. (a) *With a sharp cutting edge.*—These are everywhere **हंसुवा** *hansua*. A kind with a heavier blade is called **पघरिया** *paghariya* or **पघरुवा** *pagharua*, or **बधरा** *badhra*, **बधरी** *badhri*, **बधरिया** *badhariya*, or **बधरु** *badhāru*. It is also called in East Tirhut **संगिया** *sangiya*, in South Bhagalpur **दाबा** *dāba*, and in Gaya **चिलोही** *chilohi*.

(b) *With teeth.*—These are called **हंसुला** *dantula*, from **दांत** *dānt*, 'a tooth.' They are also called **कैचिया** *kainchiya*, of which **कचिया** *kachiya* is a variant in South-East Bihār.

74. **हंसुली** *hansuli* is a small sickle without teeth, principally used by girls for cutting spinach (**साग** *sāg*), and by toddy-sellers (**पासी** *pāsi*) for cutting palm-trees. The **पहंसुल** *pahsul* is a fixed upright sickle, which is kept in position by the foot resting on the wooden base in which it is fixed, and is used for cutting spinach and other vegetables. In Patna and Gaya, **कत्ता** *katta* is an instrument used by Doms for cutting bamboos, and **क्योचा** *kyoncha* is an instrument for barking wood.

75. The above names are also used for the curved part of the blade. The straight part of the blade is called **नार** *nār* or (to the east)

लार *lār*. Other names are दंडी *dānri* (South-West Shahabad), नरिया *nariya* (Gaya), and नाब *nāb* (Patna). The handle is बेंट *bent*.



The ordinary Sickle (hansua), and that of the Toddy-seller (hansuli).

CHAPTER II.—RAKES USED ON THE THRESHING-FLOOR.

76. This is खेना *akhaina*. It is a kind of hooked stick used for pushing the sheaves under the bullocks' feet while the grain is being trodden out. This word is only used south of the Ganges. Local variants are खेना *khenā* and खेना *akhena* (Patna, Gaya, and South Munger), खेन *akhain* in South-West Shahabad, and उखेनो *ukhaino* in South Bhagalpur. When it has five prongs, it is called पचखा *pachkha* north of the Ganges, in South Munger, and in Shahabad, and पाँचा *pāncha* also in the last district. This is also called in South Munger पाँचख *pānchakh*.

CHAPTER III.—GRANARIES.

77. These are of four kinds—

1st.—*A structure of straw or brushwood in the open air.*—These are बहार *bakhār*, बहारी *bakhāri*, or कोठी *kothi*. Local names are बेड़ी *berhi* north of the Ganges generally, टेक *thek* in South Bhagalpur, and बदारी *badāri* (also in South Bhagalpur) or मुनहर *munhar*

in South-East Tirhut. In Tirhut a गोडी *gohi* is a round कोठी *kothi*; जबर *jabra* in Gaya is a small granary.

2nd.—*Underground pits for storing grain.*—These are everywhere खाद *khād*, and also (south of the Ganges) खाता *khatta* or खाता *khāta*. Local names are चौर *chaur* in South-East Tirhut, माट *māt* in Gaya, and खाध *khādh* or खाता *khādha* in South Bhagalpur.

3rd.—*Granaries inside the house.*—In Sāran डेहरी *dehri* is a small circular closet for holding grain, and is generally made of wattle and mud. The कोठी *kothi*, कोठिला *kothila*, or कोठिली *kothili* is everywhere generally made of sun-baked mud, and is larger.

4th.—*A space surrounded by mats for holding grain* is ठेक *thek*. A granary made of straw only is in South Bhagalpur खोंचरी *khonchri*, and in South Munger बाँध *bāndh*.

78. The *support* of the granary is गोर *gora* generally. Local optional names are बेसना *besna* (South-East Tirhut), बैसक *baisak* (East Tirhut and South Munger), खुरा *khūra* (Patna), and ओटा *ota* (Shahabad).

79. The *cover* of a कोठी *kothi* is everywhere except in South-East Bihār पेहान *pehān* or पेहना *pehna*. In Sāran and Gaya it also means the plug or stopper (see § 81). Local names are जपना *jhapna* (South Tirhut and South Munger), धपना *dhapna* (East Tirhut and South Bhagalpur), and चाक *chāk* (Patna, Gaya, and South Munger). The opening covered by it is मुँहखार *munhkhār* in Sāran. In the same district the cover of a बखारी *bakhāri* is बाँध *khomp*.

80. The *bottom* is called everywhere पेंद *pend*, पेंदा *penda*, पेंदी *pendi*, or पेनी *peni*. The South Bhagalpur form is, however, पेंदी *pendo*.

81. The *hole* through which the grain is removed is generally आन *ān* or आना *ānā*, local names being आणन *ān* or मोहना *mohkhā* in East Tirhut and Patna, and मुँह *munh* north of the Ganges. The plug for filling the hole is दबकन *dabkan*, or in the south-east मुँदन *mūndan*. In Sāran and Gaya it is also पेहान *pehān* (see § 79), and in South Bhagalpur डेपी *thepi*.

82. A heap of grain is डेरी *dheri* or रास *rās*. In Gaya it is also सिल्ली *silli*. In South Munger a smaller heap is called कुद्री *kuddi*.

83. Various earthen vessels are used for holding grain. These are north of the Ganges generally कुँरा *kūnra*, माट *māt*, गेहा *ghāla*, or हंरिया *hanriya*. मटुका *matuka*, खोंद *chhonrh*, चेरु *cherui* are also used, but principally to the west. South of the Ganges we have चरवा *charua*,

खुम *khum*, खोरा *khora*, and मटकी *matki* in Patna, Gaya, and South Munger (the last two also in Tirhut); चौंड़ *chhōr* in Shahabad, and कुंरी *kūrī* in South Bhagalpur.

84. The covers of these are the same as those mentioned above; the local names are डकना *dhakna* (Shahabad), जकना *jhakna* (East Tirhut and Gaya), and मुन्दन *mundan* (East Tirhut and South Bhagalpur).

85. An earthen cupboard similar in shape to the कोठिली *kothili*, but used for keeping cooking-pots and curd-dishes, &c., is called जबरा *jabra*.

SUBDIVISION V.

IMPLEMENTS AND APPLIANCES USED IN CONNECTION WITH CATTLE.

CHAPTER I.—THE FODDER-CUTTER AND TROUGH.

86. This is गंड़ा *ganrās*, गर्रांस *garāns*, गंड़ाचा *ganrāsa*, or गंड़ाची *ganrāsi*. Local variants are गंड़ची *ganrsi* in North-West Tirhut and गर्रांसा *garānsa* in South Tirhut. The word गंड़ाची *ganrāsi* is the usual one. It has a short heavy handle. Other similar implements are दाव *dāv*, टंगाड़ी *tangāri* (Tirhut), and (in Patna, Gaya, and South Munger) काकुट *kākut* or कंकुट *kānkut*. The गंड़ा *ganrās* and गंड़ाचा *ganrāsa* are properly heavy implements at the end of a long handle, four or five feet long. They are weapons rather than fodder-cutters.

87. The heavy wooden part immediately over the blade of the fodder-cutter is called जाली *jāli*, जलिया *jaliya*, or मुंगरी *munگری*. Sometimes, especially to the east, it is simply called बेंट *bent*.

88. The blade is गंड़ाची *ganrāsi*, &c., as above. The handle is north of the Ganges मूठ *mūth* or मूठी *mūthi*, and south of it बेंट *bent*.

89. The knob at the end of the handle has various names, viz. एरा *era* north of the Ganges generally, हूर *hūr* in North-East Tirhut, ठेकवा *thekwa* in South-West Tirhut and in Shahabad, and आरहक *ārhak* in South-West Shahabad. Elsewhere no special name has been noted, unless we include मूठ *mūth* and मुठिया *muthiya* in South-East Bihār.

90. The spiked part of the blade, which goes into the handle, is खुरा *khura* or खुरी *khuri* to the west generally. Also, north of the Ganges, to the west, गोड़ा *gora*, and in North-East Tirhut चोबी *chobhi*.

A very general name is नार *nār* (East Tirhut, Patna, Shahabad, and South Munger), नारी *nāri* (Gaya), or लार *lār* to the east generally.



Fodder-cutter (*ganrāsi*) and block (*theha*).

91. The *block on which the fodder is cut*.—This is north of the Ganges and in Shahabad डेवा *theha*. Another name is परिबड *parikath* (Shahabad and North-East Tirhut), or परिबड *pariath* (South-East Tirhut and Gaya), परकडो *parkattho* or परैठो *paraitha* (South Bhagalpur), and परबडा *parhata* (South Munger). Other local names are कुकटना *kukatna* (Shahabad) and निहुवा *nisuha* (South-West Shahabad).

92. The *feeding-trough*—When made of earthenware this is नार *nād* or नार *nānd* generally, a local variant being लार *lād* or लार *lāed* towards the east.

93. In Champāran and North-East Tirhut पथिया *pathiya* is a basket used for the same purpose; elsewhere it is ओरैसा *oraisa*. In the same tract a wooden trough for feeding cattle is called नार *nāw*, a general name for the same being कठरा *kathra*. In Shahabad चरन *charan* or चरनी *charni*, in Gaya गौरी *gauri*, and in South Munger गौरी *gonri*, mean a long feeding-trough of sun-dried mud.

CHAPTER II.—THE MUZZLE AND BLINKERS.

94. The *net cattle-muzzle*, which is put on them when treading corn and at other times, is जाब *jāb*; local variants being जाबा *jāba* (Gaya) and जाबी *jābi* (East Tirhut, Patna, and South Bhagalpur). North of the Ganges (to the west) जाबी *jābi* means a smaller muzzle, put on calves to prevent them eating earth. Instead of जाब *jāb*, जाबी *jābi* is used in South Munger. मोचरी *mohri* in Shahabad is a rope attached to the head-rope of an animal to prevent it opening its mouth too wide.

95. The *conical wooden frame* put on a calf to prevent it suckling its mother is डील *dīl*, with for local variants डीला *dīla* (Shahabad

and the east) and **दोखो** *dilo* in South Bhagalpur. In South Bhagalpur another name is **कंटेखो** *kantelo*.

96. In Patna **दाथा** *dhātha* is a piece of wood tied round a bullock's mouth to prevent it eating. Elsewhere strings are used, and are called in Tirhut **बेरुवा** *berua* (west), **काजरी** *kajāri* or **लागामी** *lagāmi* (south-east), **तेमा** *tema*, (north-east), and **जूना** *jūna* (east generally).

97. *Blinkers* for cattle are in Sāran and Champāran **अनपट** *anpat*, and in Tirhut and the south-east **खोला** *kholsa*. To the east generally they are also **खोल** *khol* or **खोला** *khola*. In Shahabad they are **चोपनी** *chhopni* or **नोकना** *nokna*, in Patna **अंधियारी** *andhiyāri*, and in Gaya **अंधेली** *andheli*. In Patna **टोकनी** *tokni* or **खोला** *khola* are the blinkers used in oil-presses or sugar-mills. The cloth tied over the blinkers is **अंकमुंदनी** *ankmundni*.

CHAPTER III.—THE WHIP AND GOAD.

98. The *whip* used in driving *bullocks* is **पेना** *pena* or **पैना** *paina*. The latter is sometimes spelt **पापना** *paēna*.

99. Its *lash* is generally **चाहक** *chābhuk*, with a variant **चहकी** *chabhuki* in the north-west. In North-East Tirhut it is **चिहि** *chhiti*. **सैंता** *sānta* is found in South Bhagalpur, and local variants of this are **साटा** *sātā* in Sāran and South Tirhut and **सात्का** *satkā* in Shahabad. **चरकी** *chharki* is used in Patna and Gaya, and **जिही** *jhitti* in South Munger.

100. The *thong* at the end of the lash is **जबू** *jhabbū* in North-West Bihār, **गिरव** (the *knot*) in North-East Bihār, **धुना** *phunna* in Gaya, **फिक** *phik* or **फुदना** *phudna* in South Bhagalpur, and **फुदना** *phundna* in Shahabad.

101. The *spike* at the end of the stick is **आरि** *arai*, of which **आरौवा** *arauā* is a local variation in Patna and South Munger and **आर** *ār* or **आरवा** *arua* in South Bhagalpur.

102. An *elephant-goad* is **अकुस** *ankus* or **आंकुस** *ānkus*. A *spear* for driving elephants is **भाला** *bhālā*, **बरहा** *barchhā*, **बरकी** *barchhi*, or (in Shahabad and East Tirhut) **बल्लम** *ballam*. Another name is **गजनाक** *gajbāk* or (Patna and Gaya) **गजनाक** *gajbāg*. The *wooden club* studded with iron spikes, with which an elephant is beaten over the tail, is simply **मुगदर** *mugdār*. The **अकुरी** *akuri* is a *wooden goad* for young elephants, and when made of bamboo it is called (in South-West Tirhut) **कनार** *kanār*.

103. **दांग** *dāng* (East Tirhut and Patna), **देंग** *deng* (Gaya), and **सोंटा** *sonṭā*, are short *sticks* which may be used for driving cattle.

चाकुन *chhākun*, चकुनी *chhakuni*, or (South-West Shahabad) चिक-कच *chhikan* and (Gaya) पिचौर *pitaur*, are twig whips used for the same purpose.

104. A horse-whip is कोरा or कोड़ा *korā* or चाबक *chābuk*, and a spur कान्त *kāntā*.

CHAPTER IV.—HOBBLES FOR CATTLE.

105. These are चान *chhān* or चाँद *chhānd*.* Other local words are पैद *pairh* or पैदा *pairhā* or (in East Tirhut) पैकर *paikar* or पैंकर *painkar* and (in South Bhagalpur) गोदानी *gorāni*.

106. A piece of wood tied to the neck of a vicious or runaway animal is डेकर *thekar* or (to the west) डकर *thakar*. In South-West Tirhut it is डोकर *thokar*, and in North-West Tirhut डोकरा *thokra*. In Patna it is डेकरा *thekrā*, and in South Munger डेकर *thekur*. North of the Ganges we often find मुंगरा *mungra* or मुंगरी *mungri*, and other local names are दगरन *dagran* (Gaya) and गरगर *garhar* or गरगरो *garharo* in South Bhagalpur.

107. A cattle chain is सिक्कर *sikkar*, सीकर *sikar*, सिक्का *sikra* or सिकरी *sikri*. Sometimes these are spelt with a dotted *r*: thus सिक्कर *sikkaṛ*, &c.

CHAPTER V.—ROPES.

108. A. Those used for cattle.—The rope for tethering cattle is everywhere पगहा *pagha*, and also in South Bhagalpur जोर *zor* or गेंडा *gentha*. In Saran and Gaya it is also तगही *taghi*. The knots or loops by which they are tied are जोर *zor* or डेका *theka*.

109. In Gaya and the south-east सेली *seli* is a hair string tied from the neck to the feet of a calf when milking a cow. In Gaya it is also called सेल *sel*.

110. A tethering-rope, by which cattle are tied to a peg, is चान *chhān* generally, or (locally) गुरा *gūrha* (North-West Tirhut, Gaya, and Shahabad), गोदानी *gorāni* (South-West Shahabad), गोदर *gorār* (Patna and Gaya), गोदान *gorāwan* (Gaya and South Munger), देहौराजोर *derhaurājor* (Gaya and North-West Tirhut), मसौ *masau* (South-East Tirhut), जोर *zor* (Champaran and North-East Tirhut), and जोरो *joro* or गोदानी *gorāni* (South Bhagalpur). Most of these

* As in the proverb गदहा गेंडाह सरग, चान तगही गेंदेहि *gadha gelāh sarag, chhān tagle gelainhi*,—the donkey went to heaven and took his hobble with him; i. e., vices follow one to a future life.

refer rather to the kind of knot or loop with which they are tied than to the rope itself.

111. A double tether for wild cattle, held by two men round the animal's neck, is north of the Ganges **दोबग्गी** *dobaggi*, or in South-East Tirhut **दोगहा** *dogahā*, in North-East Tirhut **दोबगन्धी** *dobagli*, in North Bhagalpur **दोबानी** *dobāgi*, and in Saran **दुबगन्धी** *dubagli*. South of the Ganges **चरन्की** *chharki* is used in Gaya and Munger in the sense of this method of attaching ropes. It is also used for the mode in which a log is attached to an animal's neck.

112. **नाथ** *nāth* is a head-rope for cattle, passing through the animal's nose.

113. **अगाड़** (or **अगार**) *agār* or **अगाड़ी** (or **अगारी**) *agāri* is a head-rope for horses, a local name being **गखन्डोर** *galkhor* in Gaya and Shahabad. **पिछाड़ी** (or **पिछारी**) *pichhāri* is the heel-rope, which is also called (north of the Ganges) **पखाड़** *pachhār*. **बागन्डोर** *bāgdor* or **बगन्डोर** *bagdor* is a rope for tying horses. **तान्त** *tānt* or **मोजन्मा** *mojamma* is the thin leather rope tied round the horse's hooks. The halter tied round a horse's neck is **गरौन्धन** *garaundhan* or **गरन्दाँन** *gardānw*, or (in Shahabad) **गर औन्धा** *gar aundha*, and (in North-East Tirhut) **गरन्धन** *gardam*.

114. To the west and north **पैकर** *paikar*, **पैंकर** *painkar*, or **पैंकरा** *painkra* is a heel-chain for a camel, while to the south-east it is used for elephants. It is also used by travelling merchants for cattle. **नकैल** *nakail*, **नकैल** *nakel*, or in Saran **नकन्डोल** *naklol*, is the nose-rope of a camel.

115. *B. Ordinary ropes.*—An ordinary rope is **रस्सी** *rassi*, **रसरी** *rasri*, **जोर** *dor*, **जोरी** *dori*, or **जेंवर** *jemwar*. **जोर** *zor* is also used, and (in Tirhut, Patna, and Gaya) **जौरी** *jauri*.* **रस्सा** *rassa* is a cable. A ship's cable is **लाहासी** *lahāsi*, or in Saran **लाहास** *lahās*; and a tow-rope, **गून** *gūn* or (in Gaya and the south-west) **गोन** *gon*. **गैन्ता** *gainta* in Gaya is a rope for carrying beams. A coil of rope in the same district and in Champāran is **घुरन्धीला** *ghurchīla*. For the ropes used by a **पासी** *pāsi* or toddy-seller, see § 375. The string used in drawing water from a well with a brass vessel (**लोटा** *lota*, &c.) is called **जोरी** *dori*; while the general name with other vessels is **उबन्धन** *ubhan*, **उबन्धी** *ubhāni*, or (in South Bhagalpur) **उबन्धेन** *ubhain*, and in North-East Tirhut **उधेन** *ughen*. The knot round the neck of the vessel is north of the Ganges and in Shahabad **अरन्धन** *arwan*, and in Patna, South Munger, and South-East

* As in the proverb **जोरी जरि गेल, पैंठन ठामे** *jaurijari gel, aintan thāme*,—the rope may be burnt, but the strands remain (even though reduced to ashes); i.e., a rich man come down in the world retains his pride.

Tirhut रौना *rauna*. Other local names are फणकी *phanki* (North-East Tirhut), फँदनी *phandni* (Gaya), फॉस *phāns* (East Tirhut and South Bhagalpur), and फँसरगाही *phansargāhi* in Gaya and South Munger. A small piece of rope attached to the vessel and then tied on to the regular well-rope is generally फणखोर *panchhor*. A local name is छोरी *chhori* (Champāran and South-East Tirhut). Its knot is मुन्धी *mundhi* in Tirhut and the north-west, and मुन्धी *muddhi* in Shahabad. A thick well-rope is रसा *rassa* or बरसा *barha*.

116. The rope which is used in working the irrigation lever (छाटा *latha*, &c.) is बरसा *barha*, with an optional variant बरह *barah* in South Munger. Other names are हथबरही *hathbarhi*, and in Champāran and North-East Tirhut उबहनि *ubahani*. The short rope joining it and the bucket by a slip-knot is फणखोर *panchhor* or छोरी *chhori* everywhere, with the following local names:—छोर *chhor* (South-West Shahabad), जोना *jota* (Saran, Patna, and Gaya and the south-east), जोनी *joti* (Shahabad and South Munger), नाधा *nādha* (optionally in Gaya), नधान *nadhān* (optionally in Saran), and बगसा *bagha* (South Bhagalpur).

117. The strings used in working the irrigation swing baskets (चाँड़ *chānr*, &c.) are known as छोर *dor* or छोरी *dori*. In Saran they are जोनी *joti*.

118. The ropes used for dragging a harrow are north of the Ganges generally हेंगही *hengahi* or बरही *barhi*, &c., as described in § 33.

119. To the west मोजर *mojar* or मोजरी *mojri* is a rope put round the roots of young trees to hold up the earth as they are being transplanted, other names (in South-West Tirhut) being गेरुसा *gerua* or (also in Champāran) बन्धना *bandhna*. In West Shahabad and Gaya it is गुरही *gurhi*, and in South Bhagalpur जड़बन्धना *jarbandhna*.

120. The generic term for a grass rope is जुना *junna* or जूना *jūna*, and in Patna and Gaya also जौरी *jauri*, and in Champāran पतखर *pathar*. It is used for tying up bundles and for cleaning vessels. Another name in Tirhut is सरपत *sarpāt*. गतान *gatān*, or in Shahabad गत *gāt*, is a straw rope for tying up bundles. Ropes for tying up bundles of sugar-cane are जोनी *joti*, उखबन्धना *ukhbandhna*, गतौरा *gataurā* (South-West Shahabad), and पंगार *pangār* (North-East Tirhut) or पगड़ा *pagra* (made of sugar-cane leaves in South Bhagalpur). गुरही *gurhi* in Shahabad and north of the Ganges, to the east generally कचरा *kachra*, and in East Tirhut ओदार *odār*, is a loosely-twisted hemp rope (but गुरही *gurhi* may be either straw or hemp) for tying up bundles of crops.

121. A rope made of the stems of the *Cytisus cajan* (*rahar*) and similar plants for tying up bundles is called बँती *benti* in Patna, Gaya, and South Munger, and बँतरी *bentri* in South Bhagalpur. In Gaya it is also called बँधेरी *bandheri*. जुनेरी *juneri* (Gaya) is a similar rope made of *kus* grass. Ropes made of thatching-grass are called north of the Ganges जहास *jhalās* or जहसी *jhalsi*. Bundles of *manj* grass twisted up for cleaning vessels are दूँडा *lanra* or नूँडा *nanra*. A thick hemp rope is बरखा *barha*, बरही *barhi*, or (in Gaya and South Munger) बरता *barta* or बरती *barti*.

122. For most of the above the word जुना *juna* or (when the rope is made of straw) गतान *gatan* may be used, or a periphrasis may be used, e.g. कुसक रसरी *kusak rasri* for जुनेरी *juneri*.

123. सूत *sūt*, सूता *sūta*, or तागा *taga*, is ordinary thread for sewing and weaving. सुतरी *sutri* or (rarely and only in the extreme west) सुतली *sulli* is twine. This in South Bhagalpur is called सुहरी *suhri*. Twisted string is south of the Ganges डररा *tharra*. North of the Ganges and in South Munger बँडल रसी *bāntal rassi*, डँडल रसी *ainthal rassi*, or (to the west) बारल रसी *baral rassi*, is used.

124. To the west चोप *chop* is string made of the bark of the *butea frondosa* (परास *parās*) or of the palm-tree. In Gaya it is called चोप *chomp*.

CHAPTER VI.—PADS FOR CATTLE.

125. These are known generally as गद्दी *gaddi* or पहाज *palān*. In Patna, Gaya, and Shahabad बखरा *bakhra* is a leather sheet which goes over this. A खरिया *kharahiya*, or in Sāran खरीया *kharaiya*, is a pad stuffed with खर *khar*, and under it is placed the कहेली *kanheli*. पेटार *petār* is in South-West Shahabad a belt for tying them, and पछोली *pachholi* a rope fastened to the animal's tail for the same purpose.

126. The pad for an ass is लेवा *lewa*, local names being पिठिया *pithiya* (Tirhut) and सुरका *surka* (also in East Tirhut) or तरही *tarchhi* (Shahabad). In North-East Tirhut and Gaya चहौनी *chhalguni* is the cover of the pad. That of a bullock is (besides गद्दी *gaddi* and पहाज *palān*) north of the Ganges and in South Munger कहेली *kanheli*, and south of it, to the west, चहाबखरा *chhallābakhra*, and to the east चहा *chhalla*.

127. An elephant's pad is गद्दी *gaddi*, and in Shahabad also गद्दा *gadda*. Underneath is placed a softer one called गदेला *gadela*.



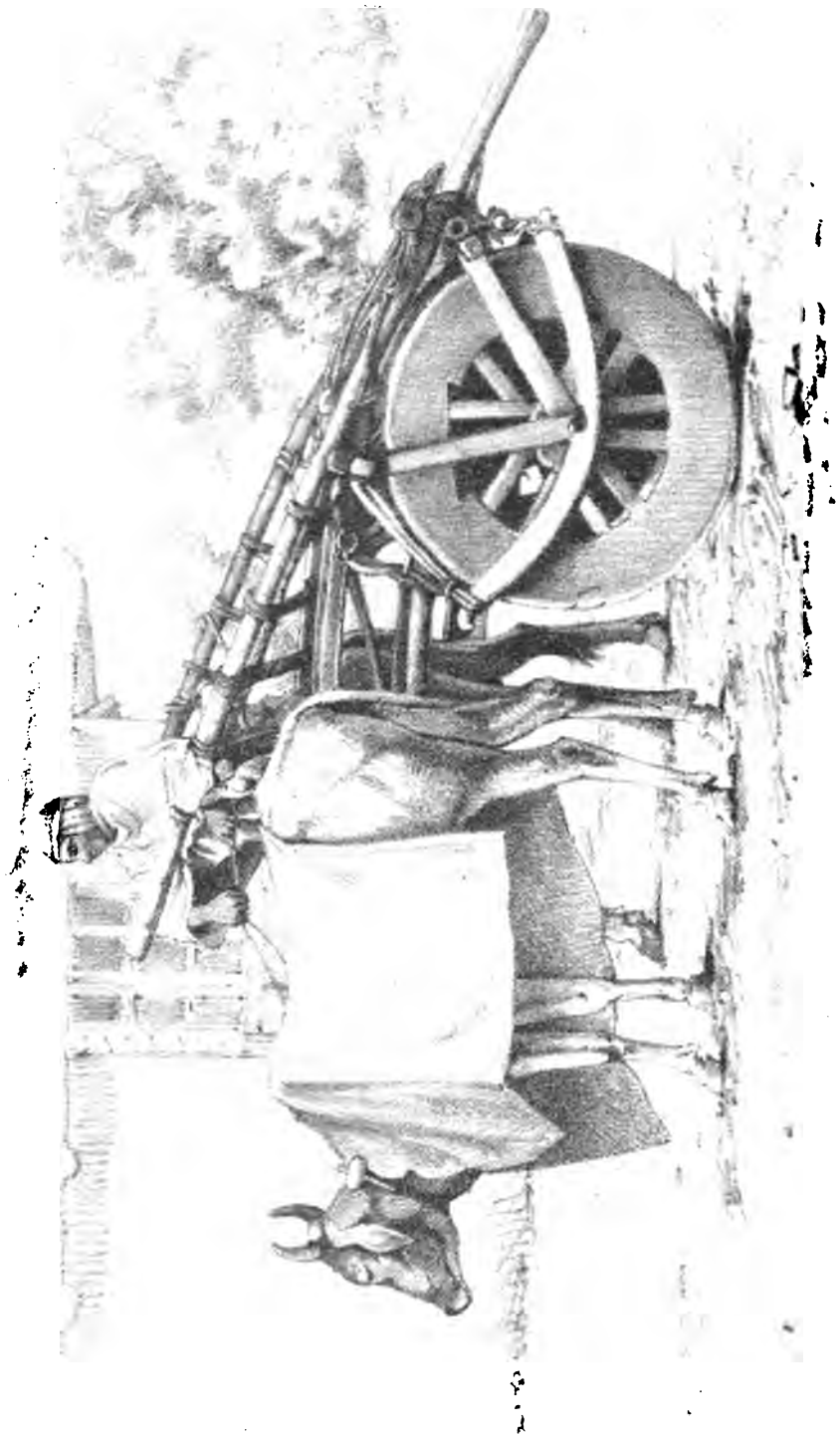

A COUNTRY CART (CHHAKRA) SHOWING THE USE OF THE BODY-CLOTH (JHOLL).

CHAPTER VII.—GRAIN-BAGS AND PANIERS FOR LOADED CATTLE.

128. These are **खाखा** *akhā*, **खीखा** *akhā*, or **तङ्गी** *tangi*;* south of the Ganges they are also **गेथिया** *gethiya* or **पट्टा** *patta*. In Shahabad, however, they are **जोरा** *jora* or **गोन** *gon*.* A large grain-bag carried on a bullock's back is in Saran **लदौरी** *ladauri*, or (also in North-West Tirhut) **लगौरी** *lagauri*. In Gaya this latter word means the cord by which the bag is fastened on the animal's back.

129. **खुरजी** *khurji* is a gunny (**तट** *tāt*) bag borne by asses and used by potters for bringing clay from earthpits (**मटिखान** *matikhān*), and by others for carrying bricks, &c.

130. A rice-sack is **बोरा** *bora* or **तङ्गी** *tangi*.

131. In South Bhagalpur a bag borne by the bullock, in which the drivers put their luggage, is **कटारी** *katāri*, and in South Munger it is **हानरवाय** *hanrway*. In Saran it is **खाख** *khās*.

CHAPTER VIII.—CANVAS, LEATHER, OR TARPAULIN COVERS.

132. These are **तिरपाय** *tirpāl* or (when made of **खाल** *chhal*, leather) **चाला** *chālā*.

133. **जूथ** *jhūl* or **जोली** *jholi* is a body-cloth put over bullocks in cold weather. In Gaya it is also **जोला** *jhola*, and in Saran **ओढ़ना** *orhna*. **जूथ** *jhūl* also means an embroidered cloth spread over an elephant's pad.

CHAPTER IX.—VESSELS FROM WHICH ANIMALS ARE FED.

134. The bag from which cattle are fed is **जोली** *jholi*, or in Champaran **जोला** *jhola*. A horse's grain-bag is **तोबरा** *tobra*. In Patna **कपार** *kapār* is a fodder bag for cattle.

135. Feeding-troughs are described in §§ 92, 93.

CHAPTER X.—DAIRY UTENSILS.

136. *The milkpail*.—This has various names, according to locality. North of the Ganges generally they are **जबही** *jhabhi* or **दुदही**

* As in the proverb **बैल ना कुदे, कुदे तजी** *bail na kūde, kūde tangi*,—a bullock does not leap, but his load does, of which the Shahabad version is **बैल ना कुदे कुदे गोन**, **ई तमाचा देखे गोन** *bail na kūde, kūde gon, ī tāmāsa dekhe gon*.

कँडिया *dudahi kantiya*; but they are also बाँड़ा *bhānra* in Champāran, घुरला *ghurla* in the North-West generally, and चपरी *chapas* in North-East Tirhut. South of the Ganges we have डहरी *tahri* or पूरा *pāra* in South-West Shahabad, and कँडिया *kantiya* in the rest of the district and East Bihar; चाँपी *chāmpi*, टेहरी *tehri*, or पतला *patla* in Patna and Gaya; दुहनी *duhni*, चुकी *chukki*, कडिया *katiya*, मँडिया *metiya*, कठली *kathli*, or कठरी *kathai* in South Bhagalpur; and चुकड़ी *chukri* or चुका *chukka* in East Tirhut and South Munger.

137. दाबा *dāba*, डहरी *dabhi* (also in Champāran), पाबा *pāba*, रास *rās*, or रासि *rāsi*, are large milkpails used in North Tirhut, and थपरी *thapri* is a smaller one. कान्नी *kānri* or कठरी *kathai*, also in North-East Tirhut कडा *kattha*, are in Tirhut wooden milkpails. In South Munger रास *rās* is used instead of रास *rās*.

138. *Vessels used in making and keeping clarified butter* (घृ *ghyū*, &c.) and curds (दही *dahi*, &c.).—This also has various names, viz. north of the Ganges दहियाची बाँड़ी *dahiyāhi bānri* or कडाची *karāhi*. A local name is करना *karna* (Champāran and Tirhut) or कौरना *kaurna* in North-East Tirhut. South of the Ganges we meet बाँड़ा *bhānra* generally, with a variant बाँड़ *bhānra* in South Bhagalpur and दहेंरी *dahenri* to the west. In Patna and Gaya we have चम्पा *champa*, महादा *mahāra*, and नदिया *nadiya*. The last is also used north of the Ganges and in South Munger. In South Bhagalpur other names are कान्नी *kantri* and चाँच *chhānchh*.

139. There are sometimes special names for special sizes. Thus while बाँड़ी *hanri* or कँडिया *hanriya* is everywhere used for the larger size, the next smaller size is in Tirhut कोबा *koha* or करना *karuna*. कोबा *koha* is also used in South Munger, and पतिला *patila* or पतुकी *patuki* is used with the same meaning in Saran. The next smaller size is कोची *kohi* or डहन्तरी *kahtari*. A still smaller size is चाँची *chhānchhi*, मट्करी *matkuri* (of earth always) or मट्कूची *matkūhi* (North-West Tirhut), and the smallest size of all is कँडिया *chhānchhiya* or नदिया *nadiya*.

140. The vessel for holding clarified butter is विवची बाँड़ा *ghivāchi bhānra*, कँडिया *kantiya*, कोची *kohi*, रास *rās* (large), चुका *chukka* (small), &c. Other names in North-East Tirhut are विवक कड़वा *ghivak karha* (large) or विवक कड़वी *ghivak karhi* (small). In Patna, Gaya, and South Munger चम्पा *champa* or चाँपी *chāmpi* are used, and रसोली *rasoli* (large) and फेरवा *pherua* (small) are met in South Bhagalpur.

141. The leather vessel in which it is exported is कूप्या *kuppa* or कुपी *kuppi*. The latter is smaller than the former, and is also used for

holding oil. In North-East Tirhut it is also called चमड़ी *chamri* or चौकठी *chaukthi*. नदोई *nadoi* is used in Gaya, and गेहा *gelha* is a similar smaller vessel.

142. *The churn*.—To churn is मचल *mahal* to the west and मचल *mahab* to the south and east. The act of churning is मचारी *mahāi* or मचारी *mathāi*; local variants being मची *mahi* in Champāran and South Bhagalpur, and मचरी *mathai* or मचन *mahan* there and in Gaya and South Munger.

143. A churn is north of the Ganges, to the west, मदनमचनी *matmahni*. In Tirhut and Gaya it is कुंदा *kūnda* or (south-east and also in Gaya and Champāran) कुदा *kunda*, and (north-east) खोर *khor*. South of the Ganges it is कमारी *kamāri* in South-West Shahabad, तौला *taula* in the rest of the district (also in East Tirhut), घोरमाहा *ghormāha* north of the Ganges and in Patna and Gaya, and महानदा *mahānda* in South Munger.

144. The stirrer or stick moved in the churn is रची *rahi* generally, and also मचनी *mahni* to the west and in Tirhut. The latter has local variants, viz. मचनी *mathni* (Tirhut and the West), महान *mahan* (West), and महनी *mahonni* (Gaya). Local names are गजही *gajhi* (South-East Tirhut), छोड़ी *chhorhi* (South-West Shahabad and East Tirhut), and घोरठी *ghorāthi* (Patna, Gaya, and South Munger).

145. The rope with which it is twisted is generally रचरी *rasri* or छोरी *dori*; but more specific names are नेत *net* (generally), with local variants नेवत *newat* or नेवता *newta* (east) and नेतो *neto* (South Bhagalpur). In Patna it is खिचनी *khinchni*, and in South Munger दन *dana*. Another name in South Bhagalpur is जोती *joti*.

146. *Various vessels*.—In South Bhagalpur काई *kāi* is a small vessel containing a quarter of a *ser* of milk. A पाथा *pātha* contains one *ser*, and a चुका *chuka* four *ser*. In Sāran a चुका *chukka* contains a quarter of a *ser*.

SUBDIVISION VI.

APPLIANCES USED IN THE CONVEYANCE OF GOODS OR PASSENGERS.

CHAPTER I.—THE COUNTRY CART.

147. The ordinary cart is called everywhere गारी *gāri*, but in Saran it is more usually गड़ी *gari*. The चक्रा *chakra* or

गाड़ा *gāra* is the large complete full-sized cart, with long bamboo poles projecting from each side in front. In North-East Tirhut it is sometimes called चखुस गाड़ी *chaghūs gāri*. The सगगर *saggār* or सागर *sagar* is a lighter and rougher kind of cart for carrying country produce. In Gaya and Shahabad it is also called लरहीया *larhiya*.

148. For carrying passengers the राथ *rath* or रान्थ *ranth* is a light four-wheeled cart used by rich people. A similar two-wheeled cart is called साँवगी गाड़ी *sāwgi gāri* or (in Gaya) साँगी गाड़ी *sauṅgi gāri*. It is also called मंजोली *manjholi* in Tirhut and Gaya and बहाल *bahal* generally, with variants बहेली *baheli* (Patna and Gaya) and बहली *bahli* (Gaya). The एका *ekka* is a two-wheeled light trap, generally drawn by a pony. In Saran it is also called गोरु बहाल *ghor bahal*. The किराँची *kirānchi* is a covered cart something like an omnibus on two wheels.

149. A cart drawn by a single pair of bullocks is दोबरदा *dobarda* or दोकरदा *dokra*. One drawn by two pairs is चौबरदा *chaubarda* (but this hardly ever occurs). In a team of three bullocks the wheelers are called धुरी *dhūri* or धुरिया *dhuriya* to the west and जोड़ी *jori* to the east, and the leader बौर *binr* or बिंरिया *binriya* to the west and जिही *jhitti* (also in Saran) or नाटा *nāta* to the east.

CHAPTER II.—THE LARGE COMPLETE COUNTRY CART.

150. This is चक्रदा *chhakra*, गाड़ा *gāra*, or चखुस गाड़ी *chaghūs gāri* (see Chapter I). Its parts are as follows:—

151. *The wheel.*—This is everywhere पहिया *pahiya*. To the west, and also in Gaya and South-East Tirhut, it is also called चक्का *chakka*.

152. The *felloe* is called मंगर *mangar*, except in Gaya, where it is जमोट *jamot*. It is made of six segments of sisu wood, called each पुठी *putthi*.

153. The *nave* is called नाह *nāh*. In Gaya it is also नह *nah*, and in Saran नाहा *naha*. Through this the spokes run completely through and through, each spoke terminating at each end in the felloe, each thus forming in reality two spokes. There are six of these double spokes altogether, making three pairs of two parallel spokes each (see illustration). These three pairs are of varying thickness. The first pair driven in is thicker and stronger than the second pair,



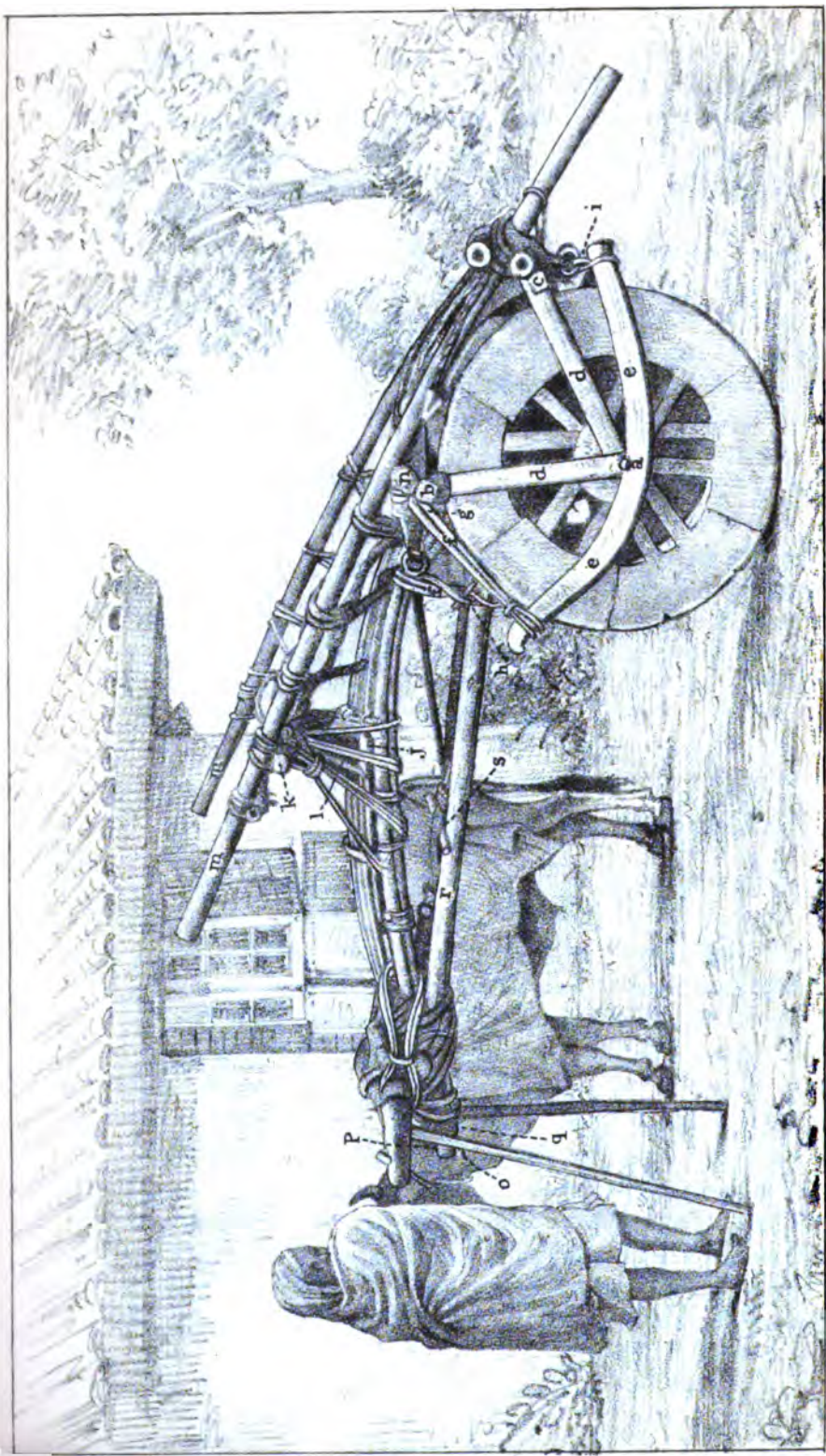

- a = projecting end of the axle.
- b = end of tokani.
- c = end of ak.
- d = the tulawas.
- e = the painjani.
- f = the jants.
- g = the karis.
- h = the suerzhi.
- i = the kulagra.
- j = the purhiya.
- k = the tij.
- l = the khuntri.
- m = the balls.
- n = the bilaiya.
- o = the sagun.
- p = the munhchopra.
- q = the utra.
- r = the lappa.
- s = the jhatka.

LISTED BY BOPIN BAHERRY DAS, Student Govt. School of Art, Calcutta.

A full-sized Bullock-cart (Chhakra), side view

and the second pair than the third pair. In crossing each other in the nave, the second pair runs through the first pair, and the third pair through the second and first. These pairs have names, viz.—

154. *The spokes.*—1.—The first pair is called **आरा ara**. This is the thickest and strongest pair of spokes in the wheel.

2.—The second thickest and second strongest pair of spokes is called **निमारा nimāra**, other names being **बेहि** or **बेही bek** (Tirhut and South Bhagalpur), **नीम धुरी nim dhari** or **नेबारा nebāra** (South-East Tirhut), and **लेवारा lewāra** (Shahabad).

3.—The weakest and thinnest pair of spokes in a wheel is called **गज gaj**.

To the west and in Gaya, both the second and third pairs are called **गज gaj**. The spokes are collectively called **डंड़िया danriya**, and to the west also **आरामज āragaj**.

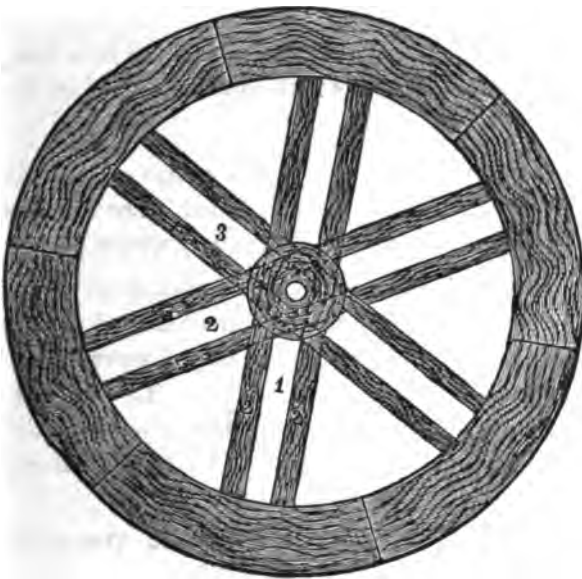

- 1. *Āra.*
- 2. *Nimāra.*
- 3. *Gaj.*

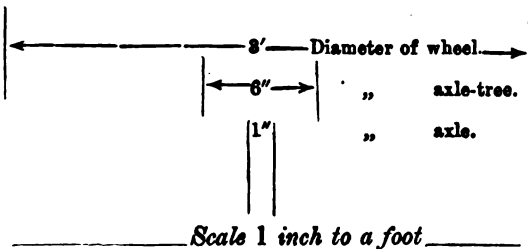

155. The six segments of the felloe are fastened together by a wedge of wood called चूर *chūr* or, in Gaya, चूड़ *chūl*, fitting tightly into two mortices, one in each of the two contiguous ends of the segment. This wedge is also called चोन्ही *chonhi* generally, also जोन्ही *jonhi* or जोन्धिया *jonhiya* to the west of the North Gangetic tract and गरब खिला *garab khilla* in Shahabad, Gaya, and South-East Tirhut. In Shahabad it is also called चोंडी *chondi* or चेंडी *chengi*, and in Patna चूड़ *chūl*.

156. The mortice in the end of each segment of the felloe is called चेह *chhed* or चूर *bhūr*, or in Saran जोह *khol*. The end of the wedge is called दाकनी *dākni*.

157. A wedge driven through the segment of the felloe from outside to tighten the spokes in their places is called पचर or पचड़ *pachchar*, or in Saran पची *pachchi*.

158. The iron hoop round the nave to prevent it from splitting is called बन्द *band* or बन *ban*.

159. Inside the nave is sometimes tightly fastened an iron tube to receive the axle. This is called the मोहनरी *mohanri*, and in Gaya also मोहनदी *mohandi*.

160. The iron axle-box passing through the centre of the nave inside the मोहनरी *mohanri*, when there is one, is called आवन *dwan*, and also (in Champaran, North Tirhut, and South Munger) बाबोन *dōn*.

161. When the outside edge of the felloe is bevelled to prevent wearing, it is called north of the Ganges and in Shahabad ताल *tāl*, with variants टलुवा *talua* (East Tirhut, Patna, and Gaya), टलुवा *talha* in West Tirhut, and टलाह *talāh* in South-East Tirhut. To the east it is also called मङ्गर *mangar*, मंगरा *mangra*, or मैगर *maigar*, with a variant मेघरा *meghra* in North-East Tirhut. In South Munger it is called कोरमार *kormār*.

162. When the outside of the felloe is flat it is called पाथर *pāthar*, but this rarely occurs.

163. *The tire.*—When the wheel is tired, the tire is called हाह *hāl*.

164. The lynch-pin is generally धुरकिल्ली *dhurkilli*, local optional names being रङ्किल्ली *rankilli* (Gaya and South-East Tirhut) and जोह *kit* in Shahabad. In East Tirhut, Gaya, and South Bhagalpur it is पचड़ *pachchar*. The peg inside the wheel is फरकिल्ली *pharkilli*, or in Saran फरकिला *pharkilla*. In a चक्रा *chakra* there is generally only one lynch-pin, on the inside end of the axle.



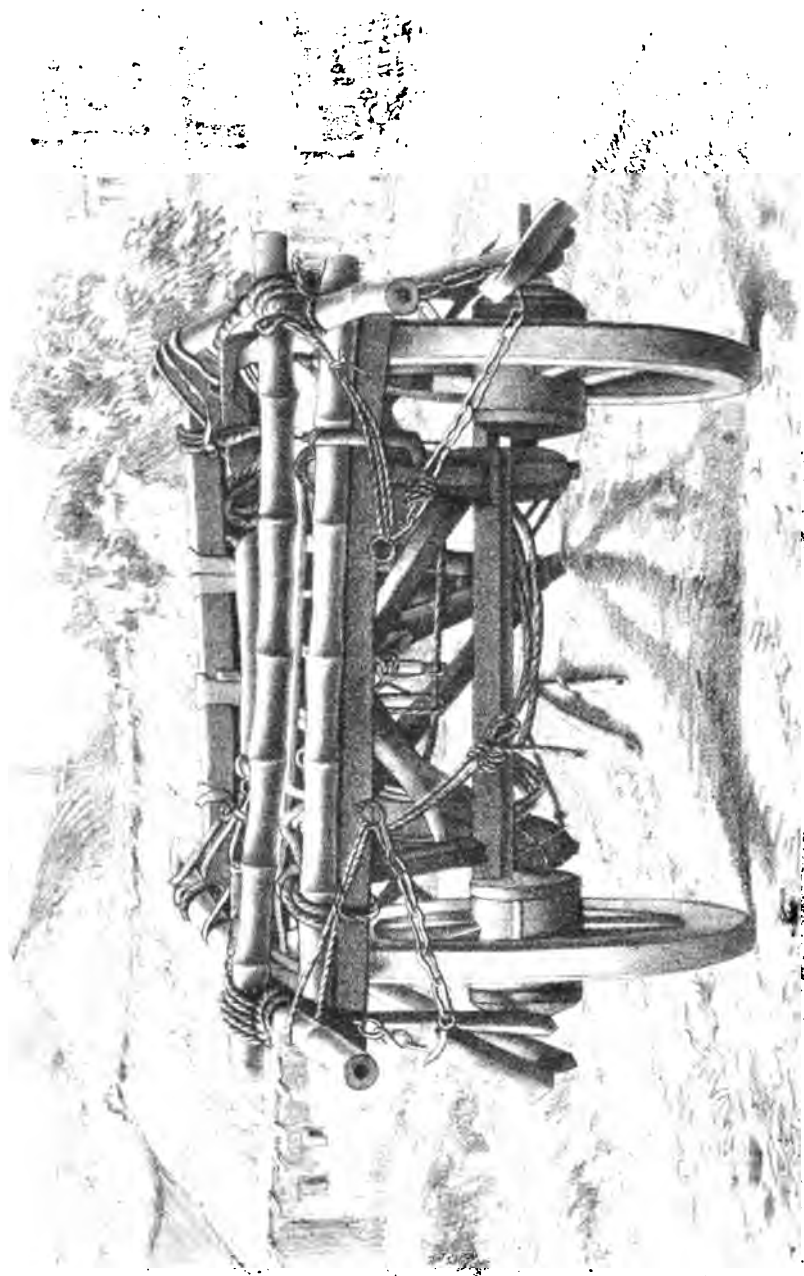

FULL SIZED BULLOOK CART (CHHAKRA) —BACK VIEW.

Painted by Hem Chandra Ghosal, Student, Govt. School of Art, Calcutta.

W. Newell & Co., Limited, Calcutta, Ind.

165. The outside washer of hemp (बन *san*) is चैनी *cheni*, चेंदी *chendi*, or (in Sāran) चैनी *chenhi*. That inside the wheel is खानन *khanan*, with variants खनन *khanan* (Sāran), खनखन *khanhan* (South-East Tirhut), खँगन *khāngan* (South-West Shahabad), and खँदन *khāndan* (South Munger, Patna, and Gaya).

166. *The axle.*—Each wheel has an axle of its own, each supported entirely by struts descending on each side of the wheel from the side of the cart to which the wheel belongs. The axle is धूरा *dhara* or धुरी *dhuri*. Sometimes a distinction is made, धूरा *dhara* being used when the axle is of wood and धुरी *dhuri* when it is of iron; but this is by no means universal.

167. *The outside supports of the axle.*—The supports outside the wheel are two pieces of wood meeting outside the wheel in front of the nave, where, at the point of crossing, they receive the axle. The upper end of one fits into one end of the front crossbar of the frame of the body of the cart (टेकानी *tekāni*, &c.), and that of the other into one end of the rear crossbar of the frame of the body of the cart (आक *āk*, &c.) (see illustration). These supports are called तुलावा *tulāwa*. They are fastened to the body of the cart by chains or ropes, called बान *bān* or बन्द *band*.

168. The curved branch of *sisu* wood which passes under the point of the axle, where it projects from the तुलावा *tulāwa*, and thus further supports the axle, is called पँजनी *painjani*, with variants पँजनी *panjani* (Shahabad optionally) and पँगनी *pengni* (North-East Tirhut). In Gaya it is called दाब *dāb*. It is pulled tightly up against the axle by three ties, two in front and one behind.

169. The front ties fastened to the fore end of the पँजनी *painjani* are called जन्त *jant*. The other end of each of these ropes is fastened to a hook, called कड़ी *kari*. One of these hooks is fastened to the टेकानी *tekāni*, and the other to the bottom of the cart, farther on in front, to one of the करहरि *karhari* (*vide post*). The जन्त *jant* are tightened by a stick called अमेही *amerhi*, or in Sāran सलैया *salaiya*, which passes between them and twists them together to the requisite degree of tightness.

170. The rear tie of the पँजनी *painjani* is called कुलंगरा *kulangra*, or in Sāran तुलंगरा *tulangra*. It generally consists of one iron chain. Two rings (खरखरिया *kharkhariya*) hang in two staples (कोँदा *konrha*) to the underside (परक *parāk*) of the rear bar (आक *āk*) of the cart. One of these rings hangs near the centre of the आक *āk*, and the other

at the end near the wheel. The chain is fastened to one, then passes round the end of the पैंजनी *painjani*, and the other end is fastened to the other ring. In this way the पैंजनी *painjani* is held in its place. The accompanying sketch will make this clear.

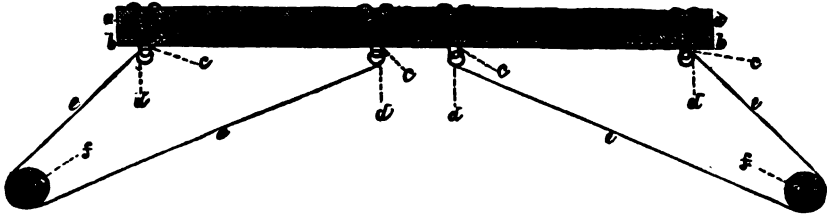

- | | |
|--------------------------|---|
| a-a = the <i>āk</i> . | d = the <i>karkhariya</i> . |
| b-b = the <i>parāk</i> . | e = the <i>kulangra</i> . |
| c = the <i>kourka</i> . | f = the rear end of the <i>painjani</i> . |

171. The *body of the cart* may roughly be described as a long triangle strongly built, lying on one surface, and arched so that its convex side is uppermost. Viewed from the side it resembles a shallow arch, and from above a triangle. Across the back a strong square or oblong frame is laid. This serves as the foundation for the carrying portion of the cart. The annexed illustration is a plan of a cart taken from above.

172. The चारु *āk* or चारु *ag* is the *main beam in the rear* of the cart. It is made of *sisu*. In Shahabad this is called चारु *ākh*. Another and lighter piece of wood going underneath the चारु *āk* to strengthen it, and also made of *sisu*, is called चरु *parāk*. A slip of bamboo tied on behind the चारु *āk* and forming the tail of the cart is known as चरु *pachhlakra*, with local variants, viz. पंचलकुरा *panchlakra* in West Tirhut, पिचलकुरा *pichhalkura* in Patna and Gaya, and पिचलकुरा *pichhlakra* or कुरा *kara* in Shahabad. In South Bhagalpur it is अंकोरा *ankora* or पचेरना *pachherna*.

173. The *front bar* of the square portion of the cart is known as टेकानी *tekāni*. In South Munger it is तेकानी *tekāni* with a dental *t*.

174. The *sides* of the square part of the body, going over the wheels and joined at one end to the चारु *āk* and at the other end fitting on to the top of the टेकानी *tekāni*, are called धुरौटी *dhurauti*.

175. The piece of wood fitting over the end of each of the धुरौटी *dhurauti*, where it joins the टेकानी *tekāni*, and holding the former in its place, is called बिदेवा *bilaiya*.

- a-a = the *āk*.
- b-b = the *pachhlakra*.
- c = the *tekāni*.
- d, d = the *dhurauti*.
- e, e = the *bilaiya*.
- f = the *pirhiya*.
- g = the *sagūn*.

- h = the *phar*.
- i, i, i = the *karhari*.
- j, j, j = the 13 *batti*.
- k = the *pachhua*.
- l-l = the *tij*.
- m, m = the tops of the two *khuntri*.
- n = the *munthapra*.

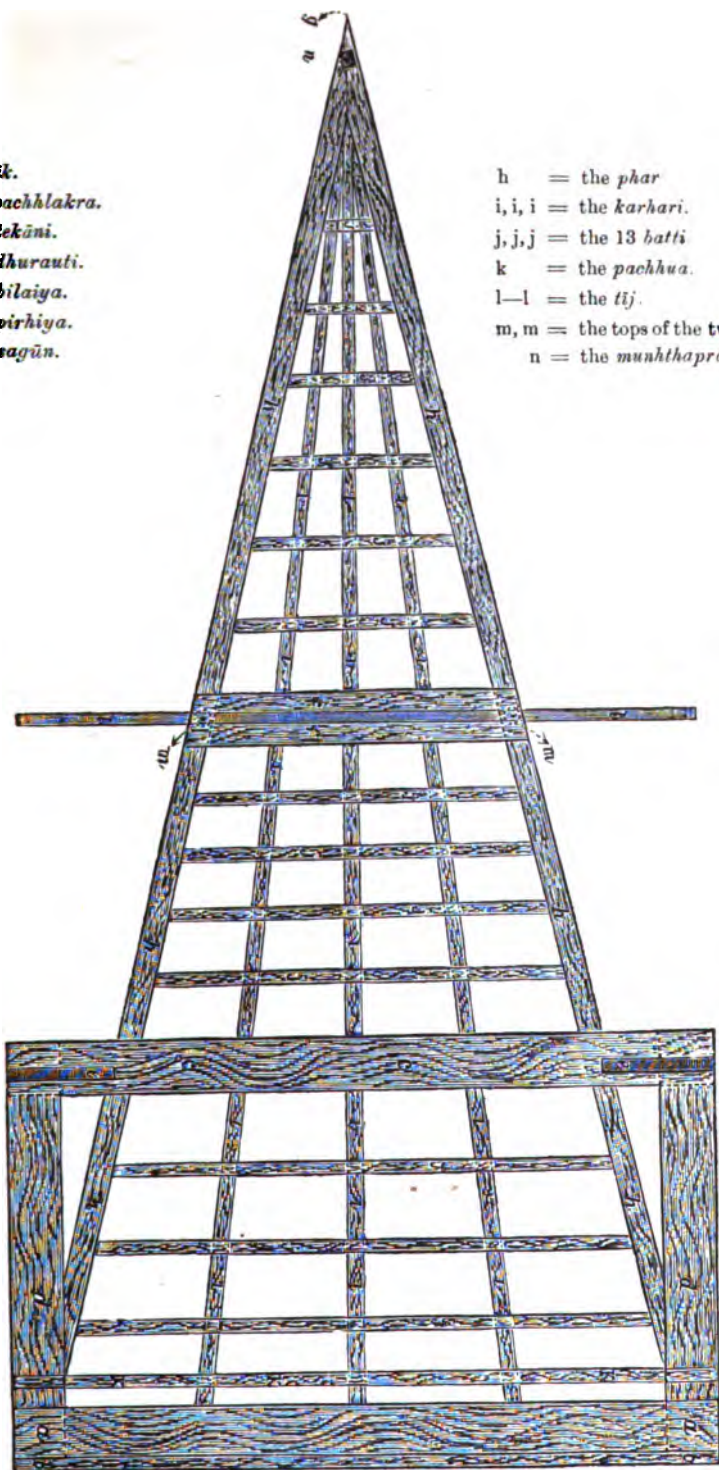

Plan of a Cart (*chakra*) from above.





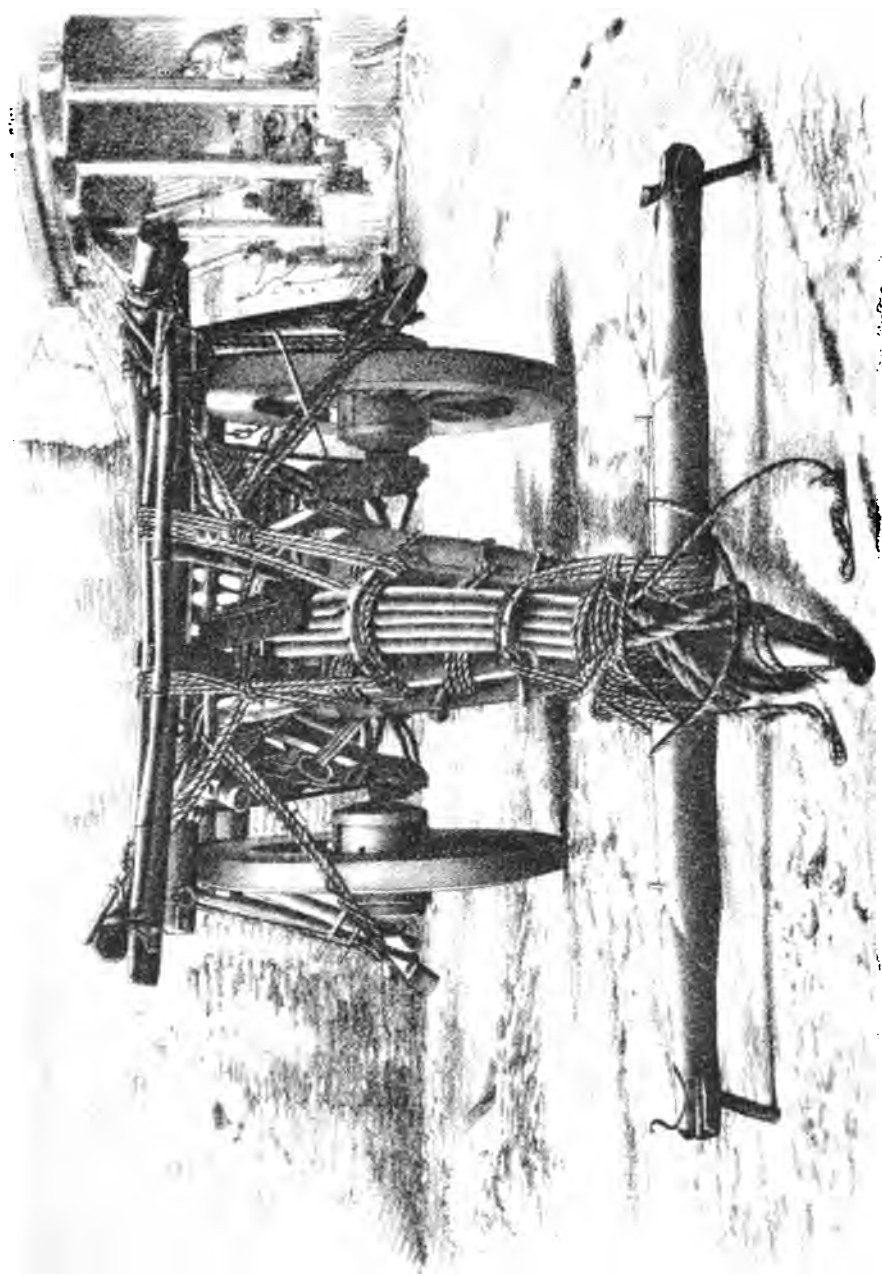

FULL SIZED BULLOCK CART (CHHAKRA)—FRONT VIEW.

176. The short stout *cross-bar* of *sisu* wood crossing the triangular body of the cart between the डेकानी *tekāni* and the apex of the triangle, in front of the driver's seat, is called पिदिवा *pirhiya*.

177. The *point* which is the front of the cart, and which forms the apex of the triangle, is called सगून *sagūn*, or in Patna and Gaya सगुनी *saguni*. The lower portion of this is called in Sāran चोप *thop*.

178. The two long *sides* of the cart, forming the sides of the triangle, starting one from each end of the चाक *āk* and meeting in the सगून *sagūn*, are known as फर or फड़ *phar*, a local variant being फेड़ *phair* (North-East Tirhut). They are also called तंगा *tānga* south of the Ganges and हारसा *harsa* in Sāran and Champaran. They are sometimes strengthened with a band of iron, called पत्तार *pattar*, बन् *ban*, or बन्द *band*.

179. The whole *bottom* of the cart is called चह्या *chhaja*. It is composed of the फर *phar*, the चाक *āk*, the डेकानी *tekāni*, and the पिदिवा *pirhiya*, and has in addition three long strips running the length of the cart, called कड़कड़की *karhari*, and thirteen cross-pieces called बत्ती *batti*, or in Sāran बत्ता *batta*, and in Gaya also चाही *chāhī*. The कड़कड़की *karhari* are also called फरी *phari* in Patna and the south-west and चपोट *chapot* in Shahabad. North of the Ganges they are also called मन्जा *mājha*, मंजीका *mānjha*, or भरानी *bharāni*. They are fastened in their places by pegs, called फरकिला *pharkilla*, कठकिली *kathkilli*, or किली *killi*, पचर *pachchar* (&c.), or कान्ठी *kānti*. Of the thirteen बत्ती *batti* or cross-pieces, there are three between the चाक *āk* and the डेकानी *tekāni*, four between the डेकानी *tekāni* and the पिदिवा *pirhiya*, and six between the पिदिवा *pirhiya* and the सगून *sagūn*.

180. This completes the description of the main frame of the cart.

We now come to the various contrivances for retaining goods in the cart. These are the following, but they are not all used in one cart:—

181. At the rear of the cart, just in front of the चाक *āk*, is tied a thick bough of wood. This is called the पड़ुवा *pachhua*. It prevents goods falling out behind.

182. Over the पिदिवा *pirhiya*, and of equal length to the डेकानी *tekāni*, runs a bamboo called the तीज *tij*, supported by two stout pillars about a foot high, each standing on one end of the पिदिवा *pirhiya*. These pillars are called the खुन्त्री *khuntri* or खुन्त्रा *khuntra*, local variant

being कुंडहरी *khuntahri* (Saran and South Tirhut) and कुंडहरी *khuntehri* or कुंडहरी *khuntihri* in Shahabad. In Gaya similar posts are called मॉची *mānchi*.

183. Two very long bamboos now form *sides*, each resting on one end of the चाक *āk*, on a बिडेवा *bilaiya*, and on one end of the तीज *tij*. Each projects behind the चाक *āk* and a long way in front of the तीज *tij*, and is called बला *balla*. Other names are बांस *bāns*, बंसबली *bansballi*, बंसौरा *bansaura* (Shahabad), or चंदवा *chandwa* (Patna).

184. Sometimes bamboos run from end to end. These are called चीप *chīp* when they commence at the टेकानी *tekāni* and run close under and fastened to the फर *phar*, up to the सगुन *sagūn*. They serve to strengthen the फर *phar*. When they run the whole length of the cart, from the चाक *āk* to the सगुन *sagūn*, and form as it were the string of the bow formed by the body of the cart, running close to and parallel with the जहाका *jhatka* (*vide post*), they are called लप्पा *lappa* or (in Tirhut) लप्पु *lappu*. They are fastened to the body of the cart by ties, known as दांगली *dāngli* in Saran, दांगरी *dāngri* in East Tirhut, बाधी *bādhi* in Shahabad, जाँदा *jaunrha* in Gaya, and सॉठ *sonth* in South Bhagalpur. Elsewhere they are simply रसा *rassa*, &c.

185. Sometimes the बला *ballā* is raised behind by a pillar (कुंडरी *khuntri*) at each end of the चाक *āk*, and the space between it and the body of the cart filled up with a rope siding. This rope siding is then called हथवाडा *hanthwāsa*, or in Patna फरका *pharka*, and in Saran एरा *era*.

186. The flat board forming the *driver's seat* is called मोहरा *mohra*, or in South Bhagalpur मोदा *morha* and in Shahabad मुंहरा *munhra*.

187. *The parts underneath the cart supporting the inner end of the axle-tree.*—There are two supports inside each wheel, like the तुलावा *tulāwā* outside. They cross each other opposite the inner end of the axle which passes through the intersection. As each wheel has a separate short axle, there are therefore two independent pairs of these, one inside each wheel.

188. The rear one of each of these pairs is called गुड़िया *guriya* or मोड़िया *goriya*, or (in Patna) खजाना *khajāna*. Like the rear तुलावा *tulāwā*, its upper end is fastened into the चाक *āk*. It is strengthened in its place in the चाक *āk* by a strut, called मेहराब *mehrab*, and the two गुड़िया *guriya* are further strengthened by a cross-piece called हंदरी

danheri, joining the two, which thus prevents them approaching each other. The annexed illustration will make this clear.

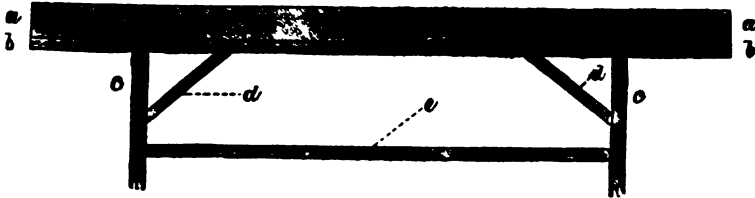

- a—a = the *āk*.
- b—b = the *parāk*.
- c, c = the two *goriya*.
- d, d = the two *mabrāb*.
- e = the *danheri*.

189. The front supports of these pairs are each called *थोप thobh* or *थोप thop*. The upper ends of these are fixed in the *तेकानी tekāni*.

190. *The apparatus for keeping the body of the cart curved.*— This consists of a set of strings called *जहत्का jhatka*, which passes right under the cart from end to end, one end being fastened to the *आक āk* and the other to the *सगून sagūn*. This is kept tight, so that it keeps the whole cart bent exactly like a bow.

The following illustration shows the arrangement :—

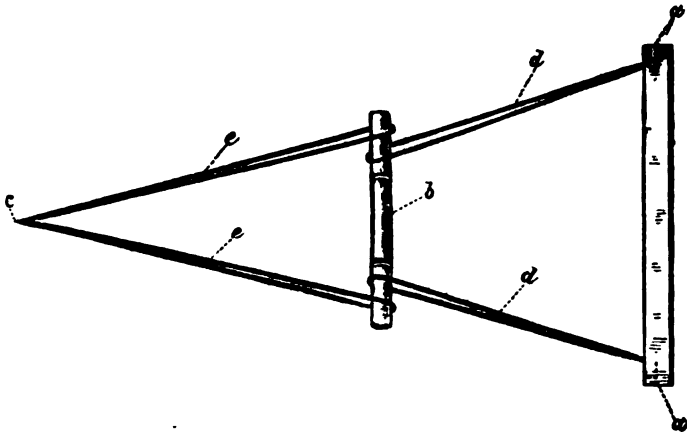

- a—a = the *āk*.
- b = the *danta*.
- c = the *sagūn*.
- d = strings fastened to the *āk*, passing round the *danta* and back to the *āk*.
- e = strings fastened to the *sagūn*, passing round the *danta* and back to the *sagūn*.

191. The *danta*, or in south Bhagulpur अनेदी *ameri*, in the above figure is a stout piece of bamboo. It will be evident from the figure that it affords increased leverage, and offers a ready means for tightening the *jhatka* when necessary. Sometimes bamboos run parallel to the *jhatka* from the *sagun* to each end of the *ak* as further strengtheners. These are called लप्पा *lappa* or (in Tirhut) लप्पू *lappū*.

192. The *chhatiya* is a slip of wood fastened across and under the body of the cart from *thobh* to *thobh*, which serves to hang baskets, &c., from.

193. The point which is the front of the cart, and which forms the apex of the triangle, is, as already stated, the *sagun* or अगुनी *sagun*. It is here that the yoke is fastened. Underneath it, to prevent the point resting on the ground, is fixed a stout peg, called उदन्ना *utra*. On the top of the *sagun*, to afford a boss for fastening the yoke to, is fixed the मुँहपोपन्दा *munhthopra*, मुँहचपन्दा *munhthapra*, or (south of the Ganges) मोथापन्दा *mothāpra*. In Champaran it is called मोहनदा *mohra*.

194. The *yoke* is जूबा *jūa*, and also in Shahabad जूचड़ *jūar*, as distinct from पाळो *pālo* or जुआठ *juāth*, a plough yoke (see § 14). The pegs passing through the ends of the yoke, outside the bullocks' necks, to prevent them shirking their work, are made either of wood or iron. The name समेल *samail* is generally applied to them when of wood, and सेमल *semal*, समाल *sammal*, or सिमल *simmal* when of iron; but this distinction is not always observed. To the east they are called कनेल *kanail*. The inner pegs towards the middle of the yoke, on the inside of each bullock's neck, are called (in East Tirhut) चिरैया *chiraiya*. They may be of either iron or wood.

195. *Props*.—When the bullocks are unyoked, the front of the cart is supported at the *sagun*, to prevent it falling forward, by the सिपावा *sipāwa* or (in North-East Tirhut) सिरपावा *sirpāya* and (in Saran) सिपवा *sipwa*. The top of this is called in Gaya मॉजा *mānja*. The prop to prevent the cart falling back is एड़ा *era*, उलरवा *ularua*, सिधुवाइ *sidhwāi*, or (in Patna) लरवा *larua*.

196. The *ropes* which go round the bullocks' necks are जोना *jota*, जोनी *joti*, or गलजोनी *galjoti*. When three bullocks are yoked, the rope which goes over the leader's neck is to the west बिंरिया *binriya* or बिरिया *biriya*, and in Saran and the east जिही *jhitti*. The rope (रसी *rassi*, &c.) by which the yoke is kept in its place is called बिहुवा *bichhua*, or in North-East Tirhut जॉक *jhok*.

197. The *mat* put in the bottom of the cart to prevent grain from falling out is चढार *chatāi* generally, but it is हरिवार *hariyār* in Patna and भंडारी *bhandāri* in South Bhagalpur. The last is also used optionally in Gaya and East Tirhut. In Saran a canvas mat used in the same way is called ढाला *dhāla*.

198. The *iron chain* for tying up the bullocks at night is generally सीकर *sikar* or जन्गीर *janjir*. Local names are पाही *pāhi* or दानर *dānrar* in Champaran and Tirhut, बेल *bel* in Gaya, and पैकल *paikal*, (also in Gaya) पैकर *paikar*, or पैकड़ *painkar* in Shahabad. The portion round the bullock's neck is called गरन्दनी *gardani*.

199. The above is the description, except where otherwise stated, of a very complete चक्रा *chakra*, which is itself the most complete kind of cart. Few carts are as complete as this; but they differ merely in being less complete, and in no other way.

200. As regards size, the cart of which the above is a description had the following measurements, a cubit being taken as equivalent to 1½ feet:—

| | Cubits. |
|--|------------------------|
| Length from आक <i>āk</i> to टेकानी <i>tekāni</i> ... | 1½ |
| „ टेकानी <i>tekāni</i> to पिदिवा <i>pirhiya</i> ... | 1½ |
| „ पिदिवा <i>pirhiya</i> to सगुन <i>sagūn</i> ... | 3 |
| Total length ... | |
| | 6 cubits, = 9 feet. |

The आक *āk*, टेकानी *tekāni*, and तीज *tij*, were each three cubits long.

The बाला *ballā* were each six cubits long, and the खुन्त्री *khuntri* one foot. The wheel was two cubits across.

The greatest height of the arch was at the पिदिवा *pirhiya*, where it was one cubit.

The height of the सगुन *sagūn* from the ground when supported by the सिपावा *sipāwa* was 2½ cubits, and that of the आक *āk*, at the same time, 1½ cubits.

CHAPTER III.—THE LIGHT COUNTRY CART.

201. This is सगड़ *saggār*, सागड़ *sāgar*, or लरहिवा *larhiya* (see § 147). In Saran it is called गाड़ा *gāra*.

This cart is rougher, lighter, and cheaper than the चक्रा *chakra*.

202. The *wheel* is the same as in the चक्रा *chakra*.

203. *The axle.*—There is only one axle (धुरा *dhūra*), which goes right across under the cart, and on which both wheels run. It runs through a block of wood which runs across from wheel to wheel, and out of each end of which the ends of the axle project. This block is called मँदरा *mandra*. The projecting ends of the axle receive the wheels, which are held in their places by outside *linch-pins* (धुरकिल्ली *dhurkilli*, &c. (see § 164). Sometimes the wheels of the सगड़ *saggar* are protected by a board outside, one end being fastened to the चाक *āk* and the other to the टेकानी *tekāni* (see §§ 172, 173). Through this the end of the axle projects, and is made secure by the linch-pin. This board is called पँजनी *painjani*, पँजनी *panjani* (Shahabad optionally), or (North-East Tirhut) पँगनी *pengni*, and must be distinguished from the different wheel support bearing the same name in the चकड़ा *chhakra*.

204. The body of the सगड़ *saggar* is not arched, as in the चकड़ा *chhakra*. It is simply a flat triangle of wood, principally bamboo. The two long sides of the body, commencing at each end of the चाक *āk* and ending together at the सगून *sagūn*, are called, as in the चकड़ा *chhakra*, फड़ *phar*, &c. As the सगड़ *saggar* has no तुलावा *tulawa*, थोभ *thobh*, or गुरिया *guriya*, the body rests directly on the axle, being supported by two blocks of wood, called तेतुला *tetla*, तेतहिया *tetaliya*, or in Saran तंतुला *tentula*, each of which rests on one end of the मँदरा *mandra*, and on which, on the other hand, the corresponding फर *phar* rests. Along the फर *phar*, and underneath it, is tied a bamboo to strengthen it. This is called बाँगर *bāngar*.

205. In other respects a सगड़ *saggar* differs little from a चकड़ा *chhakra*, except that it is built lighter and almost entirely of bamboo. As the body is not arched, the former has of course no जहटका *jhutka*, &c.

CHAPTER IV.—THE BULLOCK CARRIAGE.

206. When it has four wheels, it is called रथ *rath* or रन्थ *ranth*. This is rare in Bihār.

207. When it has two wheels, it is called बहल *bahal*, with variants बहेली *baheli* (Patna) and बहली *bahli* (Shahabad and Gaya).

208. This cart is almost exactly the same in principle as the चकड़ा *chhakra*, except that it is generally built lighter. On the square portion at the back is reared a kind of canopied seat, called साँगी *sāmgi* or साँगी *saungi*; hence the cart is also called a साँगी गाड़ी *sāmgi gāri*.

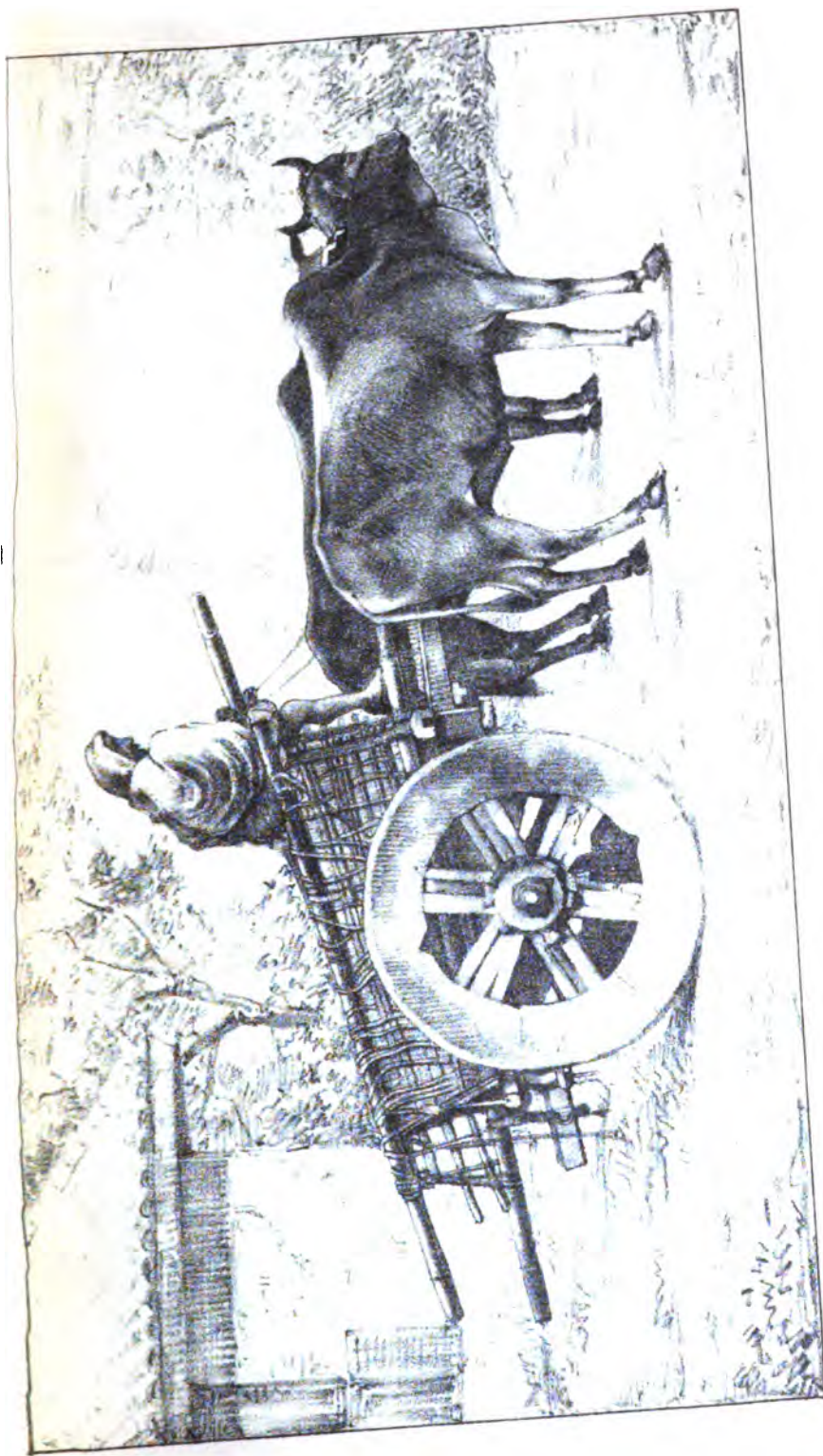

The light Country Cart (Saggar)

Painted by Suro Prosunno Mukerjee Student, Govt. School of Art, Calcutta.

Printed by Shri Ram Narain, Govt. School of Art, Calcutta.







THE BULLOCK CARRIAGE (SAUNGI GÁRI)

209. Its parts are as follows :—

The wheel.—As in a cart (see § 151 and ff.).

The leather washer is called चकनी or चकडी *chakti*, गद्दा *gadda*, or बिहरी *bihari*.

210. *The axle.*—As in a cart (see § 166).

211. *The supports of the wheels and axles.*—These are the same as in a चकड़ा *chhakra* (see § 167 and ff., § 187 and ff.).

212. *The body of the vehicle.*—The lower part is like a चकड़ा *chhakra*. Over it is placed the following, the whole of which is called सँगी *sāngi* or सौंगी *sāungi*.

213. The frame of the seat is पट्टी *patti*, local variants being पट्टा *patta* (East Tirhut and Patna), पट्टिया *pattiya* (East Tirhut and the west), and बौदन्दी *boudandi* (Gaya). Its supports are खूँटा *khūnta* or खुंटा *khunta*. On these are ornamental brass knobs, called फुलिया *phuliya*. The posts supporting the awning are दन्दा *danda* or दन्दा *danta* (East Tirhut and the west). The top of the awning is चकरी *chakri* or (in Shahabad and Gaya) ठकरी *thatri*, and the stuffed cover to keep off the sun is गद्दा *gadda* or गदेला *gadela*. In South Munger it is गद्दी *gaddi*. The net forming the bottom of the seat is सँगी *sāngi* or सौंगी *saungi*, and the leather guard of the body inside the wheels is धमाका *dhamāka*.

214. The two long sides are called फड़ *phar*, &c., or तँग *tānga*, as in the चकड़ा *chhakra*. Between them are placed narrow planks, called मँजा *mānjha*.

215. The supports of the body behind are धरुवा *dharua* or रँधरुवा *dhanrua*, and similar smaller ones inside are बावली *bāwli*.

216. The दँतुवा *dantua*, or in Saran धाला *dhāla*, is the back seat for carrying luggage, and it is also called अरानी *arāni* in South-East Tirhut and Champaran. डोरी *dori* are the strings forming the side of the awning, and परन्दा *parda* is the side awning, which may be raised or let down as required. In Saran it is also called ओहार *ohār*.

217. The rails on each side of the driver's seat are बल्लि *balli*.

218. In other respects the bullock carriage is the same as the चकड़ा *chhakra* (see Chapter II).

CHAPTER V.—THE PONY CARRIAGE.

219. This is nearly the same as the bullock cart, on a smaller scale, except in the following particulars :—

220. The *wheel* is the same as in the bullock carriage (see § 151 and ff.).

221. The *axle* is धूरा *dhāra* or धूरी *dhāri*, which is strengthened inside by a short metal tube, सॉमा *sāmma*, सामा *sāma*, or सामी *sāmi*. In North-East Tirhut the latter is also called साम *sām*. There is one of these inside each wheel, and they act as a kind of washer. There is only one axle (धूरी *dhāri*), on which both wheels run. Outside each wheel are a pair of तुलावा *tulāwa*, but inside there are no थोभ *thobh* or गुरिया *guriya*, as in the bullock cart (see § 187 and ff.). Round the ends of the टेकानी *tekāni*, the चाक *āk*, and the axle, forming a triangle outside the wheel, is tightly tied a rope called the जन्त *jant*, and just above the lowest angle of this triangle (*i.e.*, just above the point of axle), is tied to it a short stick serving as a footstep, called सलार *salāi* or सलैया *salaiya*.

222. The तुलावा *tulāwa* are fastened to the चाक *āk* and the टेकानी *tekāni* (see §§ 167, 172, and 173) by iron hooks, called अंकुरी *ankuri* or (Champāran, South Tirhut, and South Munger) अंकुरा *ankura*. South of the Ganges they are also called in Shahabad and South Bhagalpur तुलार *tulāi*. चाक *hāl* is the tire of the wheel. The leather splashboard over the wheel is तख्ता *takhta* or तख्ती *takhti*. In South-West Shahabad it is called पट्टरा *patra*.

223. The props of the *body* are दन्दा *danda* (west), दन्ता *danta* (east and Champāran), or खूंटा *khūnta*. The top of the awning is चहत्री *chhatrī*, and the roof of it is चह *chhat* or (in Gaya) तरक *tarak*; गदेला *gadela* or (in South-East Tirhut and South Munger) गद्दी *gaddī* is a cushion at the top to keep off the sun. The awning at the sides is परदा *parda*, or in Sāran घटा डोप *ghata top*, which is fastened by iron rings, कड़ी *kari* or (in Gaya) खोली *kholi*. The ropes which support the awning poles are हथुआंसा *hathuānsa*, and the rope trellis between the two rear awning poles चौक *chauk*. This last serves as a back to lean against.

224. The खूंटा *khūnta* or खूंटरा *khuntra* are posts which support the body in front on the axle. धरवा *dharua*, धारवा *dhārua*, or (in South Bhagalpur) धालुआं *dhālūān*, are the posts which support the body on the axle behind the खूंटा *khūnta*. बावली *bāwli* or बाँधी



PONY CARRIAGE (EKKĀ), WITHOUT CANOPY.

Lith. by Hem Chunder Dutt, Student, Govt. School of Art, Calcutta.

Printed by Abdool Rohum Govt. School of Art Calcutta.





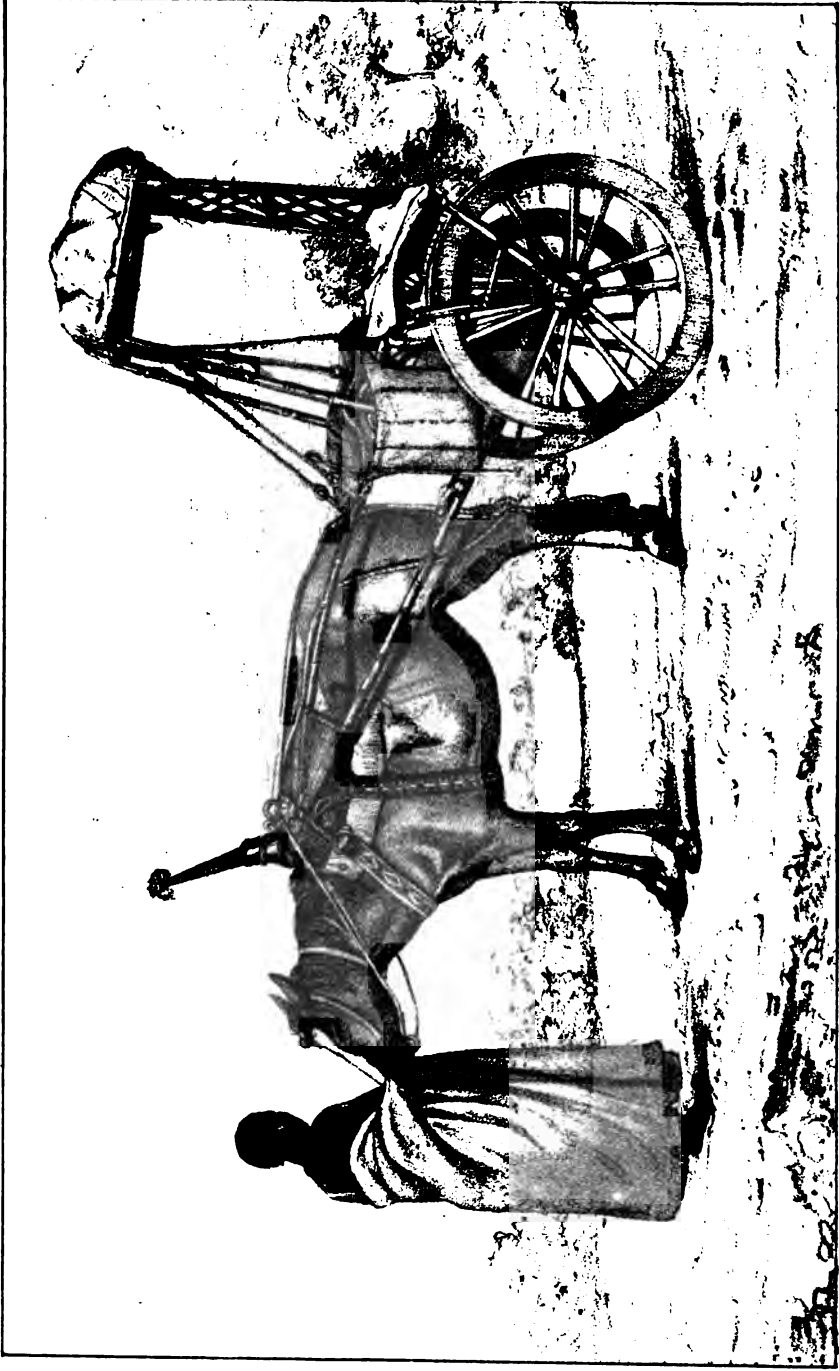

AN EKKA WITH CANOPY.

bauli are similar posts behind the **खुंटा** *khanta*, but in front of the **धरवा** *dharua*. They are quite inside the body of the cart. To the west of the North Gangetic tract they are also called **गज** *ganj*. The **पोंछिया** *ponchhiya* or (to the west) **पिछुवा** *pichhua* are the pointed ends of the lower shafts behind. In South Bhagalpur they are called **दगन्धी** *dagli*. **तान** *tān* are the four iron bars which support the body on the axle. Two of them are called **खुंटादान** *khuntādan* or (in South-West Shahabad) **गजदान** *gajbāg*. **मंजा** *mānja* are similar wooden supports. The **साँवगी** *sāmugi* or **साँगी** *saungi* is the twine net under the seat, and the straps which keep it up are the **साँगी के नारी** *saungi ke nāri*. The **गोड़िया** *goriya* are side ropes which fasten the splash-board to the axle, and the **धमाका** *dhamāka* is the leather siding inside the wheels. The four curved bamboo shafts are **तंगा** *tānga* or (in Patna) **टांगा** *tānga*. The **खानी के नारी** *khāti ke nāri* is a strap inside, fastening the body to the axle in front of the **साँगी के नारी** *saungi ke nāri*. The **लदान** *ladāo* are cross-pieces of bamboo from shaft to shaft, forming the body of the cart. In North-East Tirhut they are called **पथी** *phathi*, and in South Bhagalpur **बत्ता** *battā*. The net at the bottom is **जाला** *jāla*, and the **जठका** *jhatka* is a strong rope behind and below, fastening the cross-pieces of the body.

225. The driver's seat is **करन्तली** *kartali*. The pieces of bamboo which run underneath from shaft to shaft, on which the driver rests his feet, are **लखोरा** *lakhora* generally north of the Ganges, or **दरन्री** *darenri* in Saran and **दंरेरा** *danrera* in South-East Tirhut. In Shahabad they are **लतेरा** *latera*, in Patna and Gaya **दरिया** *danriya*, and **तरेरा** *tarera* in South Bhagalpur. The **गोड़िया** *goriya* or (in South-East Tirhut) **घोड़िया** *ghoriya* are pieces of wood which join the upper and lower shafts. **पन्की** *pankhi* are pieces of leather joining the upper and lower shafts near the yoke. These shafts are also fastened by a leather rope called, north of the Ganges, **मुथरा** *muthra*, and to the south of it **मोथरा के नारी** *mothra ke nāri*, or in Shahabad **मुन्हरा के नारी** *munhra ke nāri*. In Patna and Gaya it is called **चबारा** *chbara*. The **मोथपन्का** *mothapra* is a brass cap fitting on to the ends of the two shafts.

226. *Harness*.—The pointed part of the saddle is **खोगीर** *khogir*, or in Shahabad and East Bhagalpur **खगूर** *khagūr*. The pad is **गद्दी** *gadi* or **गद्दी** *gaddi*. The wooden block is **कठरा** *kathra* or (in South-West Shahabad) **कठला** *kathla*. The rings through which the reins pass are **करा** *kara* or **रास करी** *rās kari*. The leather surcingle going over the saddle, round the horse's shoulders and across his chest, is **पुश्तंग** *pushtang* or **पुश्तङ्ग**

puslang. Another name is जोत *jot*. The leather belly-band is तबू *tang*. रास *rās* means the reins; तावा *tāva* or (in South Bhagalpur) तवक *tavak*, the leather cover of the saddle; नांगला *nāgla*, नगला *nagla*, or तसमा *tasma*, the straps which fasten the shafts to the saddle; and कंचो *kainchi*, the wooden side supports of the saddle. Other names for this last are कंचिया *kainchiya* (Champan and Tirhut), गोरिया *goriya* (South Tirhut, Patna, and Gaya), टिकठी के लकरी *tikthi ke lakri* in South-West Shahabad, and टेकठी *tekthi* in South Bhagalpur. दुमची *dumchi* or दुमकजा *dumkaja** is the crupper. The bridle is पूंजीपहा *pūñjī patta*, and the iron bit लगाम *lagām*. The martingale is जेरबन्द *jerband*, the cloth over the eyes which serves as blinkers अंधारी *andhāri*, the neck-ornament कन्धा *kantha*, and the brass moon on the horse's forehead चाँद *chānd*.

227. गंजिया *ganjiga* or तोबड़ा *tobra* is the bag hung on either side for holding the passenger's shoes, &c.

228. The above is a description of an एका *ekka* when the canopy is attached. When this is taken down, a back railing is added, कटहरा *katahra*, instead of the rear posts, and instead of the two front posts two shorter ones are set up, one on each side of the driver's seat, called निमन्दाना *nimdanda*.

CHAPTER VI.—THE COUNTRY BOAT.

229. Boats are of various kinds. The following may be noted :—
The general term for a boat is नाव *nāv*, and to the west also नैया *naiya*.

230. The larger kinds of boats are उलंक *ulānk* (which has a long narrow bow overhanging the water in front), मेल्हनी *melhni* (which has a broad bluff bow), पटेली *pateli* or पटेली *pataili*, also called in Saran कतरा *katra* (on which the boards forming the sides overlap and are not joined edge to edge), कच्चा *kachchha* (which is shaped like a square shallow box, without proper bow or stern, and is steered with two rudders. It takes great burdens, and will go in very shallow water), and the सरङ्गा *saranga*, or in Shahabad सलीमा *salima*, and in Tirhut सरिन्ना *sarinna* (which has a round bottom for shallow water).

231. Smaller varieties are दोहट *dohat* or in Shahabad दोएट *doēt* (which has a flattish bottom for shallow water, and has its bow and

* The fate of the *ekka* pony is well shown in the proverb दाना न रास दुध चाँद दुमकजा *dāna na ghās, dunu sāñh dumkaja*,—no grain or grass, and the crupper on night and morning.

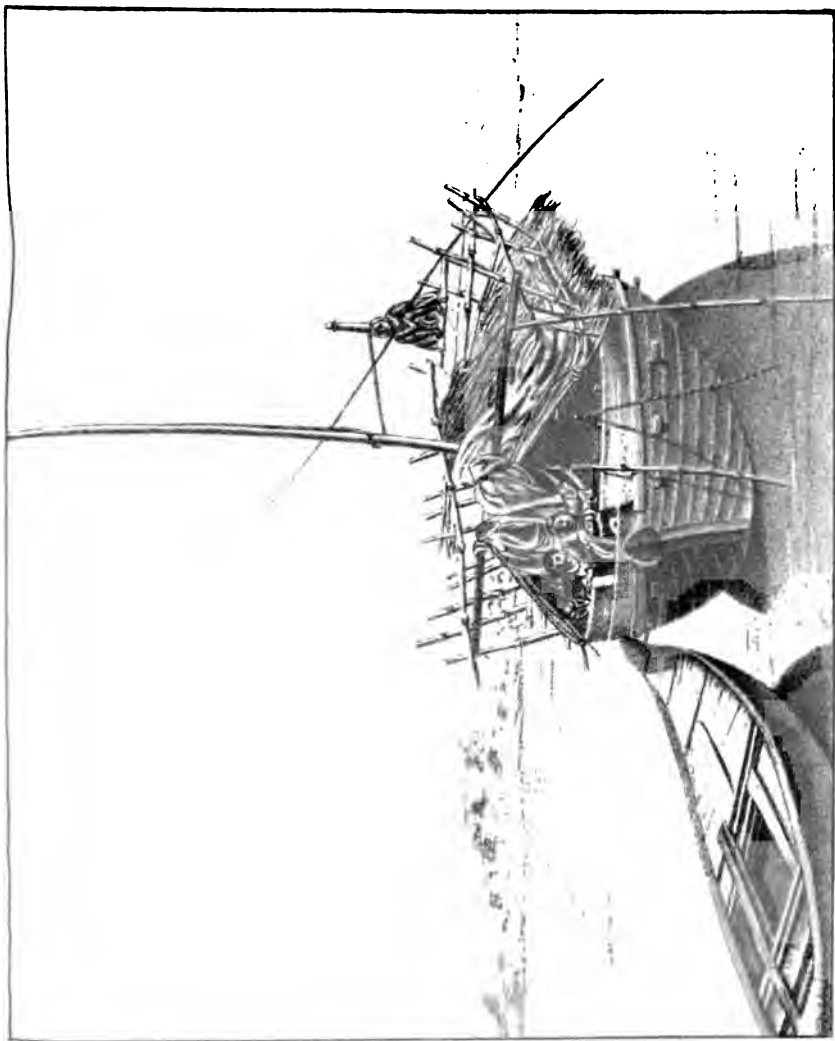

PALWĀR .

Lith. by H. C. Ghosal, Student Govt. School of Art Calcutta.

SARANGA .

Printed by A. Rahman Govt. School of Art Calcutta.



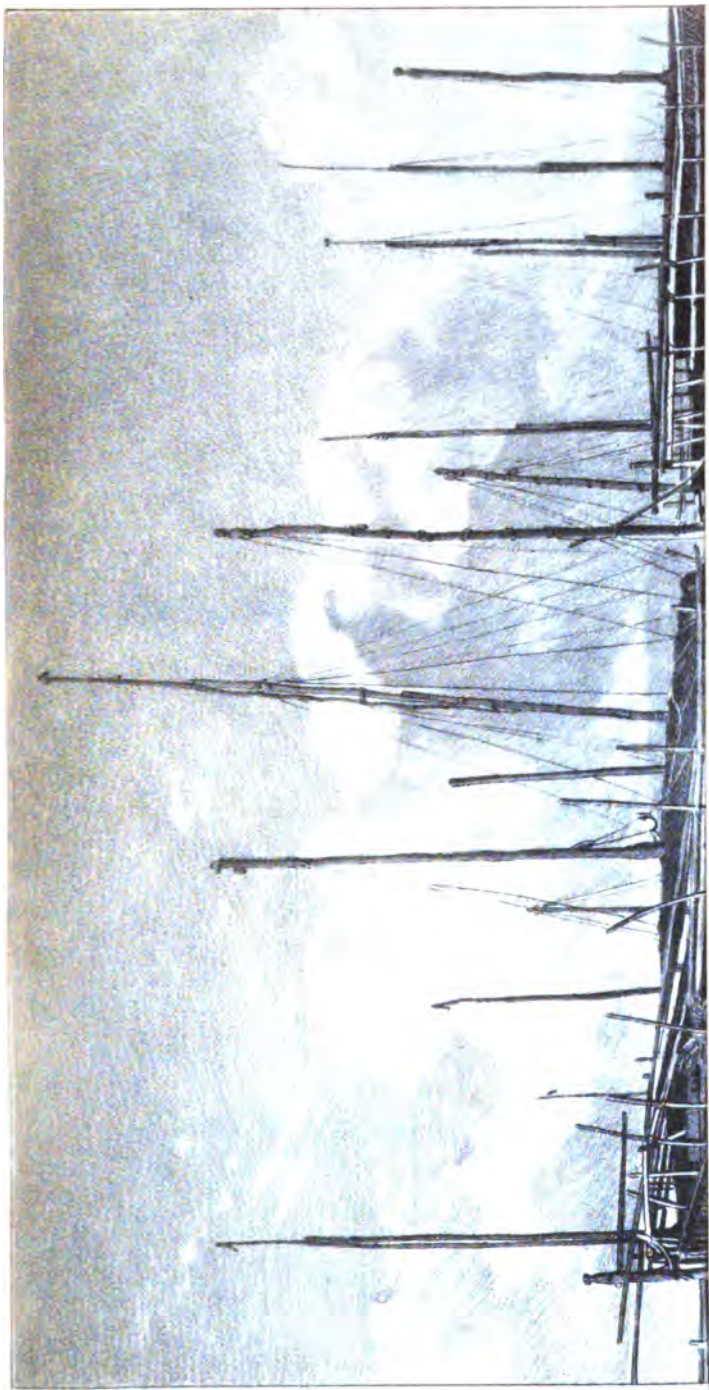

Stern of a
Melhni.

Dohat.

Pansühi.

Bow of a Dengi Machhua.

BOATS USED IN BIHAR.



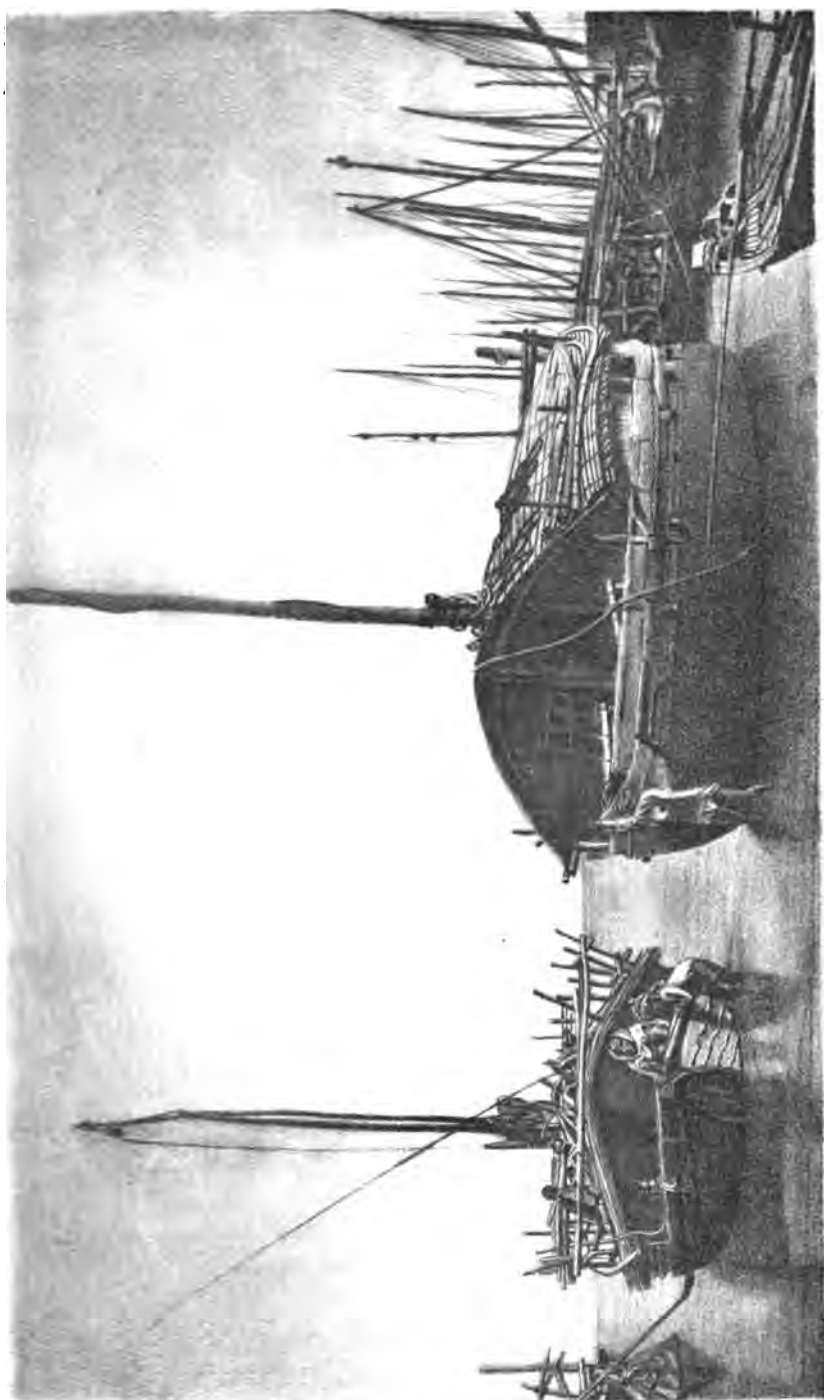

Stern of a
Melhni.

Dohat.

Pansûhi.

Bow of a Dengi Machhua.

BOATS USED IN BIHAR.



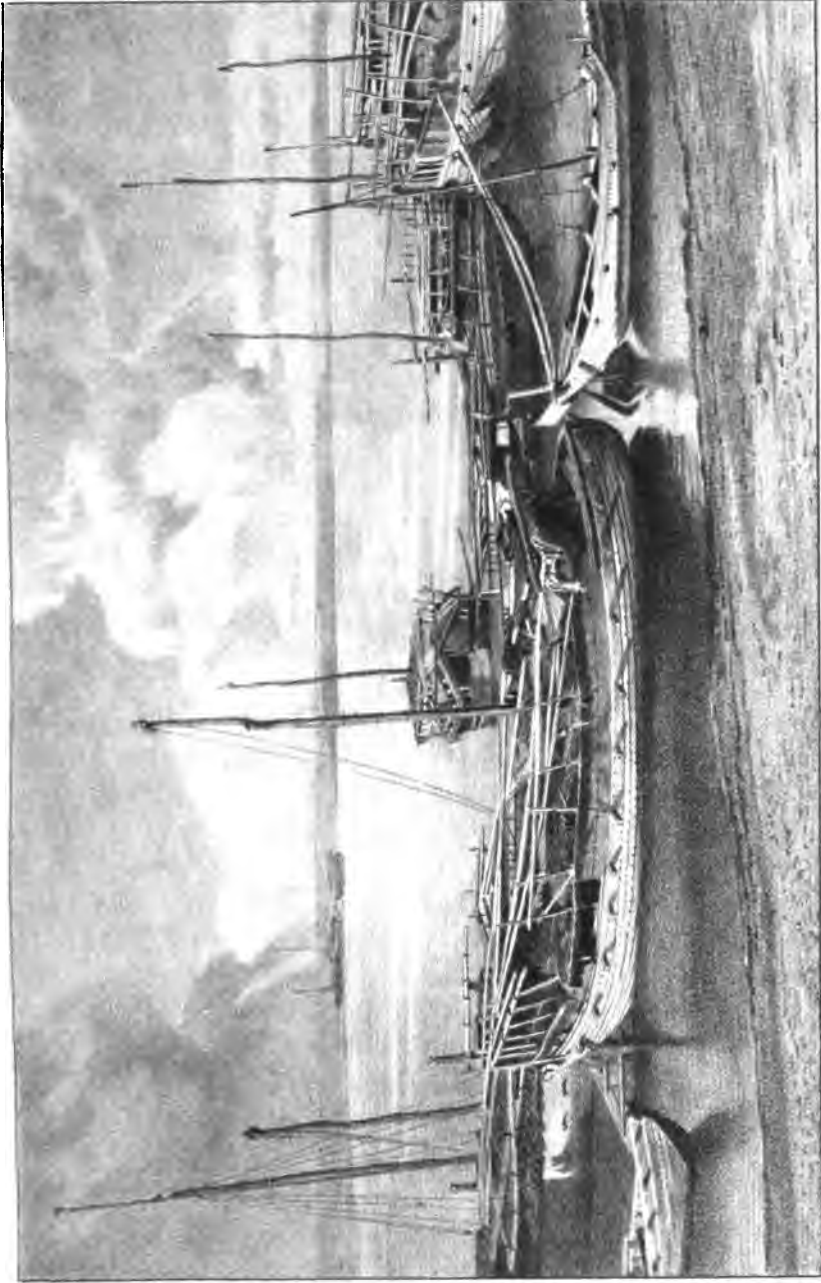

SARINGA.
PATAILL.

PATAILIS.
ULÄNK.



stern portions cut out of solid wood), and पन्सुही *pansūhi* (which has a round bottom, but goes in shallow water).

232. The smallest kinds are पलवार *palwār* or skiff and एकठा *ektha* or dug-out. The latter is also called बंगरा *bangra*. Also the कोलनैया *kholnaiya*, with both ends rising like a gondola well out of the water, and which cannot sink. Another similar boat is called the डेंगी मछुवा *dengi machhua*, or dingy. घरमरी *gharnaī* (South Bihar) is a temporary raft made of water-jars (जड़ा *ghara*) and bamboos tied together.

233. The parts of a boat are as follows:—The thwarts are गूड़ा *gūrha* and the ribs बाना *bāta* or (in Champāran) ठरुबाना *tharbāta*, ठरुहिया *tharhiya* (in Champāran and North-West Tirhut), गोखा *gochha* (in Saran and South-West Tirhut), गुच्छा *guchchha* (in North-East Tirhut), and काक *kāck* (in South-East Tirhut). Smaller transverse ribs are बाँक *bānk*. The outer planking is हार *hār* or (in South Munger) बाकल *bākal*, (in Champāran and West Tirhut) बगल *bagal*, and (in North-East Tirhut) काकल पाटी *kāckhak pāti*. In Gaya it is जलमहार *jalamhār*. In Shahabad the planks which run from end to end in the length of the boat are अकार *akār*, and देवाल *dewal* is also used to mean the “wall” or side planks. The flooring inside the boat is पाटन *pātan* or पलवटन *palwatan*, or in Saran पटौरी *pātauri*. A long plank running over this is in Shahabad अपनी *apti*. The grating above the bottom of the boat is चाली *chālī* or (in South-West Tirhut) उरुहा *urhha*, and (in North-East Tirhut) पटार *patāi*. In a पटौली *pataili* the planks at the bottom which run from end to end are लेवा *lewa*, and in other kinds of boats मरिया *marīya* or (in North-East Tirhut) मरेया *mareya*, and in Saran मोरिया *moriya*. The platform on which the rower sits is पटौरी *pātauri* or बिटन *bitan*. When on the roof of a large boat, it is बीट *bit* or पटार *patāi*, or in Shahabad हलमचानी *halmachāni* or मचान *machān*. The deck planks in the middle are पाटना *pātna*. चचार *chachār* is brushwood put in the bottom to stand on. करुवा *karwa* or कंरुवा *kanruwa* are the posts which support the thwarts. जीका *jonka* are iron rings to which the roof of the boat is fastened by ropes. In North-East Tirhut and South Munger they are called करी *kari*.

234. When a boat is calked with the bark of the परास *parās* tree (*butea frondosa*) the calking is called रसवत *rasvat*, and when with hemp it is गहनी *gahni*. अटार *atār* (in Champāran and North-West Tirhut) is string used for calking.

235. The keel, which is the first plank laid in making a boat, is सिक्का *sikka*. In Champāran it is सखन *sahan*, and पतैन *patain* or दण्डा *danda* in South-East Tirhut. It runs the whole length of the boat, and hence

शिखा *sikka* is also used to mean the two ends of the boat. The length of the boat is दार *dawar*, and the stern post गलही *galhi*. The prow is मलङ्ग *malang*, मांगि *māngi*,* or मांग *māng*.

236. The rudder is पतवार *patwār* or (in North Tirhut) पतिवार *patiyār*. In Gaya it is पडवार *patwār*. This is properly the lower piece. The rudder post is गोल *gol*, (in Shahabad, North-East Tirhut and, optionally, South Munger) खम्हा *khamha*, or in Gaya गौहा *gauha*, and it is fastened to the thwart by a rope called नथिया *nathiya*. The tiller is सेला *saila* or (in South Munger and North-East Tirhut) दन्टा *danta*, and the socket in which it works बनरा *banra* or (in North-West Tirhut) डेल *thel*, and (in North-East Tirhut) डेहरी *thehri*. One rope, by which the rudder is fastened to the boat, is गंकरकासा *ganrkassa*, and another, by which it is held up, is अंकवरीया *ankwariya*. The steersman is मांजी *māngji*.

237. सेवता *sewta* or (in South-East Tirhut) सोता *sota* is the wooden vessel used for baling out water. An oar is दांड *dānr*, a paddle करवार *karuār*, केरवार *keruār*, or in Saran करवारी *karuāri*, and the blade of it पाना *pāta*. A punting pole is लगी *laggi* or लग्गा *lagga*.

238. The mast is गुरखा *gurkha* or मस्तूल *mastūl*, or in Shahabad गुनरखा *gunarkha*, and the yard is मोरनी *morni*. The mast is raised on a post to which it is spliced. This is दरसुधा *darsūdha* or असोधा *jasodha* in South Munger and Tirhut, जारसुधा *jarsudha* in Champāran, and जावसुधा *jawsadha* there and in North-West Tirhut. The socket in the bottom, in which the post is stepped, is दरसुधा के मलिया *darsūdha ke maliya* or महवा *mahwa*. The सतवनिचाँ *satwaniyān* is the thwart to which the post is tied. It is called in South-East Tirhut सूत *sūt*. The pulleys are घिरनी *ghirni*, and the sail is पाल *pāl*, and in Shahabad सूते *sūte* or सुतेवनिचाँ *surtwaniyān*.

239. The tow-rope is गून *gūn* or (in Gaya and the south-west) गोन *gon*, which is tied to pieces of bamboo called बेरुवा *berua* or खंडा *khūnta*, or in Shahabad बारुवा *barua*, which the boatmen press against their shoulders when hauling a boat up stream. The man who tows is गुनवाह *gunwāh*. लहासी *lahāsi* is a cable, and लङ्गर *langar* or गिरानी *girābi* the anchor. A large iron anchor is लोहलङ्गर *lohlangar* or गिरानी *girāmi*.

240. To draw water (of a boat) is पानि तोड़ *pāni torab* to the east and पानि तूर *pāni tūral* to the west, e.g. रै कच्छा बडत कम पानि तूरत

* The most comfortable seat is in the bow. Hence the proverb जनिका खेवा नहिं छे पगिजा मांगि सवार *janikā khewa nahin, se agila māngi sawār*,—the fellow who hasn't money to pay his fare takes the bow seat.



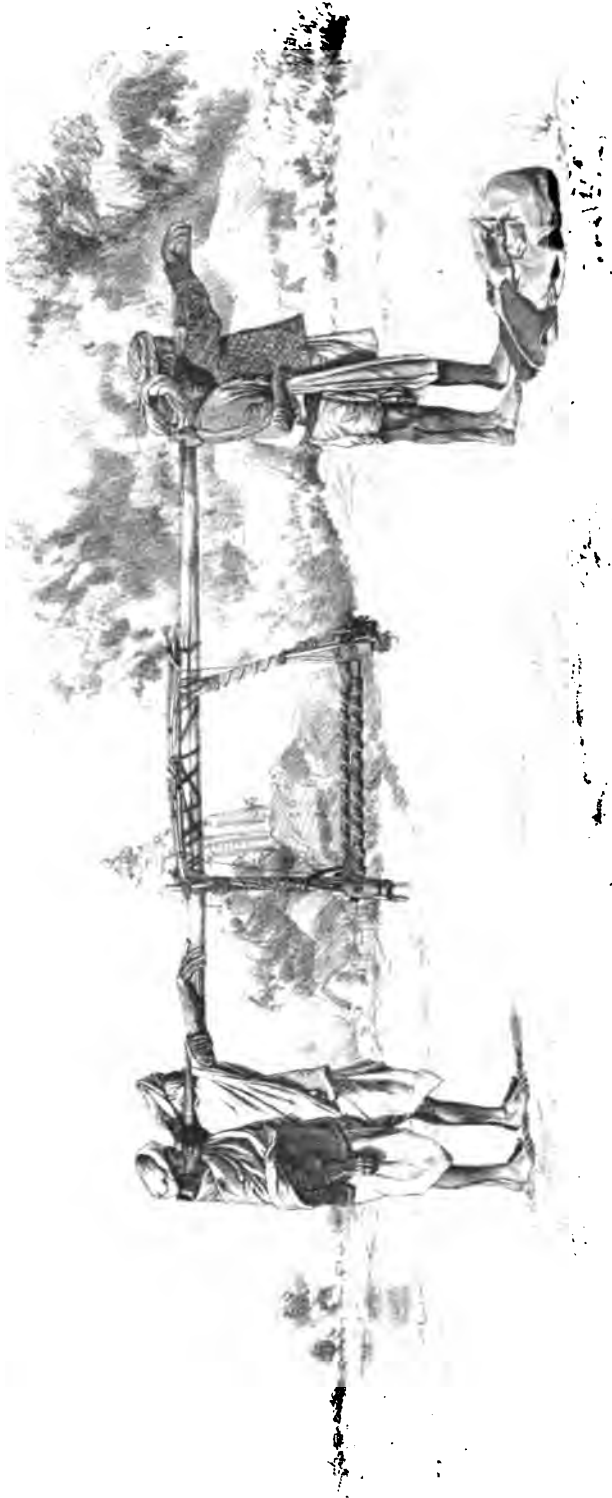

THE ORDINARY COUNTRY LITTER (DOLI).

बा i *kachchha bahut kam pāni tarat bā*,—this *kachchha* draws very little water. To be aground is डोकन *tikab*.

CHAPTER VII.—THE LITTER.

241. The litter is खटोली *khatoli*, डोली *doli*, or (in North-East Tirhut) खोटोली *khotli*. डोली *doli* is also used for the ornamented litter used at marriages, which is also called in South Bhagalpur चन्दोली *chandoli* or तद्वन्तद्वन्ती *tartarwān*. The last word is said by natives to be a corruption of the Persian تاخت راول *takht rawān*, or moving throne. In the west it is also called नालकी *nālki* or बिबहती पालकी *biyahuti pālki*.

242. The bamboo pole is बाँस *bāns*, and from it the litter is suspended.

243. The litter itself is खटोली *khatoli*, and is a kind of small bed (चरपाय *charpāy*) with a bottom made of rough twine (सुत्रो *sutri*). The sides and ends of the bed are पाटी *pāti*. In South Bhagalpur the sides are called पट्टी *patti* and the ends सिरवा *sirwa*. At each end two pieces of split bamboo run up from each corner, meeting about 3 feet above the bed, and thus forming a triangle. These bamboos are called सिपावा *sipāwa*, or in South Munger सिपावा *sipāha*, and in Sāran सिपवा *sipua*, and they are fastened to the corners of the bed, and, at the apex of the triangle, to the pole by a string called बरकास *barkas*. This string is also twisted round the सिपावा *sipāwa* to strengthen them. A bamboo stick passes through the pole just behind the rear सिपावा *sipāwa*, and, descending perpendicularly, is braced to them by strings. This is called टेनुवा *tenrua* or टेरुवा *terua*. It prevents the pole slipping round. The illustration shows a litter as carried by four persons, but this kind is more usually borne by two.

244. The feet of the bed are called पोषा *paua*, and the strings for tightening the bottom of the bed are ओरचन *orchan*, and also in Shahabad ओरदावन *ordāwan*.

245. Fastened to the pole over the bed, and in a plane parallel to it, is an oblong framework of bamboo slips for supporting the canopy. This is called ठट्टरी *thatrī*, and in South Bhagalpur also चहत्नी *chhatni* or चहत्तरी *chhatrī*; and the string braces descending from its four corners to the four corners of the bed, to keep this awning steady, are called तान *tān*.

246. The illustration shows a litter without the curtains. When a woman travels in it, the whole is enclosed in a set of curtains like a bell-mouthed bag, called ओहार *ohār* or परन्दा *pardā*.

247. A superior kind of litter, used by richer women, is मेघाना *meāna*, मेघाना *meñāna*, महप्पा *mahappha*, दान्नी *dānri*, or दानिया *danriya*. It has a domed roof, called ठात्री *thatri*, supported on eight pillars (four at each side), called दन्ता *danta*. The side-boards of the body are called दीवाल *diwāl*, or in Shahabad दिहवा *dilhā*, and the doorway दुहारी *duhāri*, or in South Munger दुहारी *duāri*. The rest is like the दोली *dōli*.

248. The बरहदारी *bardari*, or in Shahabad बरहदारी *barahdari*, also called in Saran बरहदिया *kharkhariya*, is the corresponding litter used by wealthy men. It is the native form of the Europeanized palankeen. In this the side-pieces at the bottom are called पाटी *pāti* or पटिया *paliya*, the net bottom बिनावट *bināwat*, the legs पौचा *paua*, the side-boards पट्टी *patti*, the four pillars at each side सिपौचा *sipaua*, the doorway दुहारी *duhāri*, and the roof चहत् *chhat*. The shelf inside at the feet end of the litter is दराज *darāj*.

249. The poles are called बाँस *bāns*, and the curved end of the front pole थोप *thop*. The four iron struts at each end are called तान *tān*, and they meet in a ring (चुकिचा *chukiya* or in South Bhagalpur चानी *sami*), which goes round the pole. The inner end of the pole rests in a socket in the end of the litter, which is also called चुकिचा *chukiya*, and also in South Munger चानी *sāmi* or खुबिया *khubiya*. The rope network filling up the space between the two lower struts at each end is called कसावट *kasāwat*, or in South Bhagalpur कसन *kasān*.

SUBDIVISION VII.

APPLIANCES USED IN RURAL MANUFACTURE.

CHAPTER I.—APPLIANCES USED IN THE MANUFACTURE OF OIL.

250. The oil-mill is known as कोल्ह *kolh* or कोल्हु *kolhu* throughout the province. In Gaya it is also केल्हु *kelhu*. It closely resembles the sugar-mill, as described in the next section, and a detailed description is not necessary. Nevertheless, owing to the circumstances stated therein, it has been found inconvenient to give an illustration of a sugar-mill, and accordingly the following description of a Patna oil-mill is here given in order to explain the accompanying sketches. To these reference can be made in reading the section on the sugar-mill, in which the few points of difference are noted. A well-known proverb

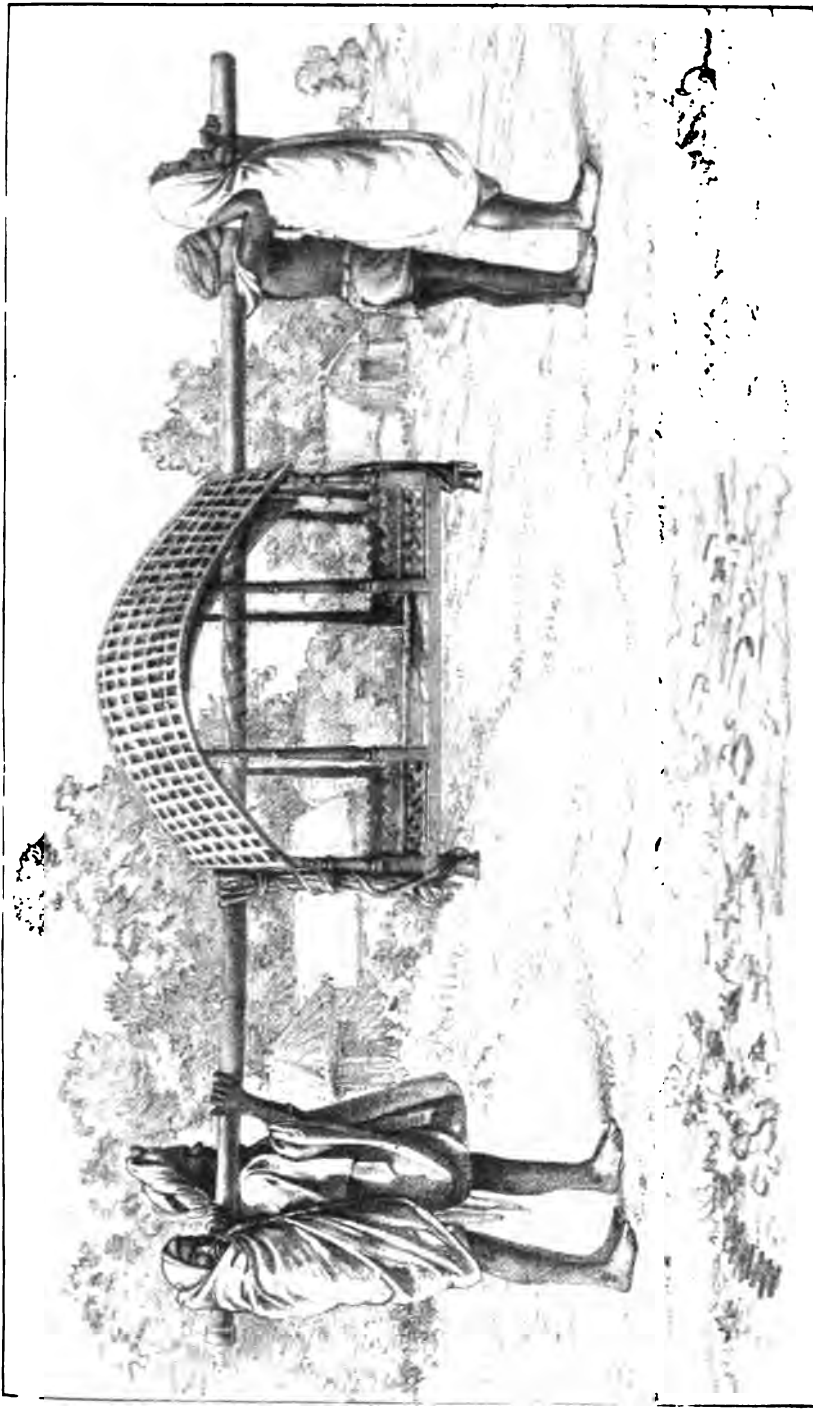

THE LITTER USED BY RICH WOMEN (MEYANA).

Lith. by Nirya Kall Mookerjee Student Govt. School of Art Calcutta.

Printed by Abdeool Robhun Govt. School of Art Calcutta.

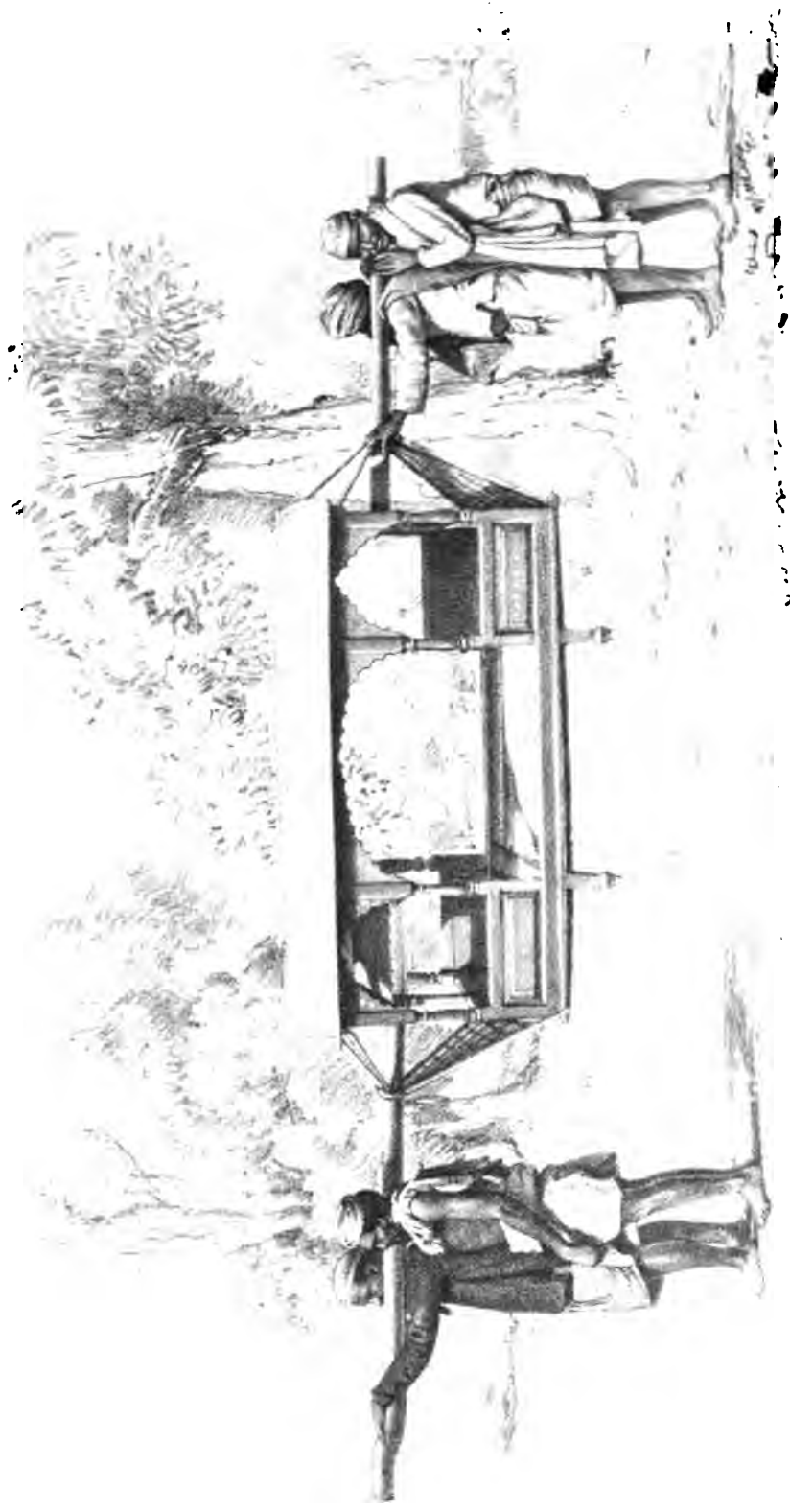

BARDARI (COUNTRY PALANKEEN).



An oil-mill, showing the manner of yoking and branding the bullock.



An oil-mill (bothu).



about the oil-mill is देह चरो जाव नहिं, कोह चाटे जाव *del khari khāy nahī, kolh chātai jāy*,—(the bullock) won't eat oil-cake when it is given to him, and yet it goes to lick the oil-press ; i.e., stolen goods are sweet.

251. *The hollow wooden block forming the bed of the mill.*—This is कोह *kolh* or कोहू *kolhu*, and in Gaya also केहू *kelhu*. In this the cavity in which the oil-seeds to be crushed are placed is known as डेट *pet* or हटा *handa*, or in North-East Tirhut कुँह *kūnh* and in Shahabad खान *khān*. In the oil-mill this cavity is shaped like an inverted cone, the apex reaching to about midway down the block. There it is about two inches wide, and thence it widens again like an hour-glass till it leads into the back of the top of the निरोह *niroh*. The lower half of this hour-glass cavity is known as अचरी *athri*. The lower end (मुँडी *mūṅṅī*) of the pestle (महन *mahan*) is just wide enough to fit tightly into the narrow part of the cavity at the waist. The upper half of the cavity is that in which the oil-seeds are placed. It has a lining of a series of longitudinal pieces of hard wood, wider at the top and tapering to the bottom, which are very tightly wedged together. These are called पाचर *pāchar*. Sometimes, when these get worn away by the constant working of the pestle, a fresh lining is put inside them. In this case the old lining is called ठरन्पचरा *tharpachra*, or in North-East Tirhut तरन्पचरा *tarpachra*, and the new inner lining पेटन्पचरा *petpachra*.

252. The block is buried very deeply in the ground to steady it. The part below ground is called जङ्घा *jangha*. Round the base a circular mound of earth is fitted, called भौंता *bhaunta*, or in South Bhagalpur भौंठो *bhauntho*, in North-East Tirhut भत्ता *bhatta*, and in Sāran मंजौटा *manjhauta* ; and in this, below the exit for oil, a space is dug out for the vessel (चह्ना *chhanna*) receiving the oil.

253. The exit for oil is the triangular hole at the bottom of the block over the above-mentioned cavity. It communicates at its upper end with the अचरी *athri*. This oil exit, together with the cavity for holding the vessel, are together called निरोह *niroh*, and in Sāran and Tirhut also नरोह *naroh*.

254. The flat top of the block is called पारा *pāra*.

255. *The horizontal board to which the bullocks are attached.*—This is called कतरी *katri*. On it the oilman (तेही *tehi*) sits, and while he drives the bullocks he at the same time keeps pressing down the seeds into the cavity with his left hand.

256. *The upright beam, or pestle, which moves in the hollow of the mill and crushes the seeds.*—This is मोहन *mohan* or महान *mahan*. To the west it is also called जाठ *jāth*, or in Shahabad मोहन *monhan*, and in North-East Tirhut मोहैन *mohain*. The ball at the end of this beam, which fits into the narrowest part of the hollow of the block, is मूँरी *mūnri*. The ferrule round this is मुकुवारी *murvāri*. The notch above this is कान्ह *kānh* or कन्हा *kandha*. The upper end of the pestle rounded off is चूर *chūr* or पूँची *pūnchhi*, and the curved piece of wood joined to this is डेंका *dhenka*, or in North-East Tirhut डेंकुवा *dhenkua*. This curved block of wood connects the pestle with the upright post which is fixed in the horizontal driving-beam : thus—

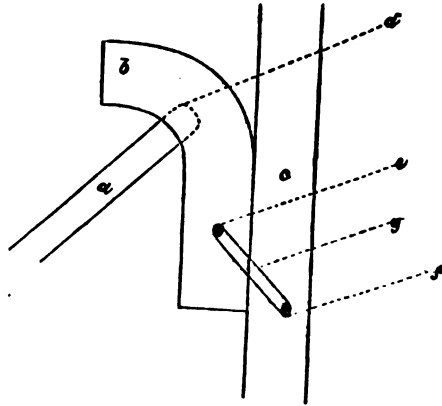

257. In the above sketch *b* is the डेंका *dhenka*, *a* is the top of the मोहन *mohan* fitting into it up to the point marked *d*. The upright post is *c*, which is fastened to *b* by a string *g* passing round the two pegs *e* and *f*.

258. The upright post is called मरथम *martham*, or in Sāran मलिक् थम *malik tham*, the pegs *e* and *f* खूँटी *khūnti*, and the string *g* नाधन *nādhan*, or in East Tirhut लाध *lādh* and South Bhagalpur लेध *ledha*. The string is generally made of straw. The upright post is fastened to the horizontal board, कतरी *katri*, by a wedge, गकिल्ली *garkilli*, which goes through the former and under the latter.

259. The horizontal board revolves round the main block of the machine; at the end of the board nearest the block is fastened a thick lump of wood called पेंटा *phenta*, or in Sāran फेता *pheta*, which acts as a kind of washer between the end of the board and the block, and which also rests against the latter, revolving in a horizontal groove (called मॉंदर *māndar*) out in the latter's exterior surface. A bamboo strut

runs up from the inner portion of the horizontal board to meet the upright post, so as to strengthen the joint. It is called **खरचाही** *khar-chāhī*, or in North-East Tirhut **खंरुचारी** *khanrchāri*, and in Gaya and Shahabad **खंरुचर** *khanrchar*.

260. *The arrangement for stirring up the oil-seeds.*—This is called **रेवनी** *revni*, or in South Bhagalpur **बरनाठी** *bharnāthī* or **उकनी** *utkani*, and does not exist in the sugar-mill. It consists of a peg, **खूंटी** *khūnti*, standing up in the cavity amidst the oil-seeds, alongside the peste; to its top is fixed a horizontal pole or handle, the other end of which is fastened to the upright post, **मरगम** *marthamh*, by another peg, **खूंटी** *khūnti*. The whole therefore revolves with the pestle, the first peg moving amongst the seeds concentrically with it and stirring them up. At the same time the stirring is rendered more effective by the peg being perpendicular and the pestle on a slant.

261. *The yoking apparatus.*—The rope which is fastened to a peg in the end of the horizontal beam, passed round the hump of the bullock and back again to the beam, where it is tied into a hole, is called **कारा** *kārha*, and the rope passing under the bullock's chest, joining the two traces thus made, is **पेटी** *peti*. The canvas pad on the bullock's hump is **कांधी** *kāndhī*, and the cloth or wicker basket by which he is blindfolded is **टोकनी** *tokni* or **खोला** *khola*, or to the east **खोला** *kholsa*. The rope from the bullock's neck up to the curved block or **धंका** *dhenka* is **पगवा** *pagha*, and the iron link fastened to this close to the bullock's neck is **बौर काली** *bhaunr kālī*. The rope round his neck, connected to the **पगवा** *pagha* by this link, is **गरदानी** *gardawāni*, or in North-East Tirhut **गरदानी** *gardāni* and in Champāran **गरदानी** *gardāni*, and that going through the bullock's nose is **नाथ** *nath*. A bullock employed in an oil or sugar-cane press is called a **नाटा बैल** *nāta bail*.

262. *Miscellaneous.*—The circle in which the bullocks move is called **पौर** *paur* or **पौरी** *pauri*, and in South Bhagalpur also **भर** *bhar*.

263. The pot into which the oil drops is called **छाना** *chhanna*. As much oil-seed as can go into the press at one time is called **गानी** *ghāni*. The oil-cake which remains after the oil has been expressed is called **खली** *khallī*, or in Sāran **खरी** *kharrī*, except the oil-cake of poppy seeds (**पोसना पोता** *posta*), which is called **पीना खली** *pīna khallī*, or simply **पीना** *pīna*.

264. To work the mill is **पेरव** or **पेरुव** *perav*.

CHAPTER II.—APPLIANCES USED IN THE MANUFACTURE OF SUGAR.

A.—THE CANE-MILL.

265. The cane-mill is known as कोरू *kolh* or कोरू *kolhu* throughout the province. Patent mills introduced by European firms are known as कल *kal*.

266. It is apprehended that the following description of a country sugar-mill will be of little else than antiquarian interest, for such mills are fast disappearing from Bihār, being superseded by the English-made iron crushing-mill made at Bihia. To such an extent has the use of country mills died out, that the writer found it impossible to find a single one in the sadr subdivision of the Patna district which was in a fit state for a photograph to be taken of it. They had all been broken up for firewood, only a few dismantled ones being available. For a general idea as to its appearance, the reader is referred to the illustrations of an oil-mill in the last chapter.

267. The following are the principal points of difference :—

- (1) The hollow in the block has perpendicular and not sloping sides, and it is hence cylindrical, and not conical, in shape.
- (2) The sugar-mill has no रेवनी *rewti*.
- (3) In a sugar-mill the pestle and its appurtenances are on a much larger scale. The मोहन *mohan* is six or seven cubits long, while in an oil-mill it is seldom more than three and a half cubits, the rest in both cases being in proportion.
- (4) The names of the parts differ.

268. *The hollowed wooden block forming the bed of the mill.*—This is generally known as कोरू *kolh* or कोरू *kolhu*. The cavity in this, in which the pieces of cane to be crushed are placed, is known north of the Ganges, to the west, as खान *khān*, or in Champāran घर *ghar*; and to the east, कुण्ड *kund* or कुंरू *kūnr*. In Shahabad it is known as हन्दा *handa* or हंरोलवा *hanrolwa*. In South Munger it is हॉन्दा *hānra*, and elsewhere south of the Ganges हन्दा *handha* or हन्दा *handā*. Round the edge, at the top of this, a rim of mud is sometimes placed to prevent the pieces of cane falling off. This is called पौंरू *pinr*. An iron ring fastened round the block to strengthen it and prevent it from splitting is बन *ban*, and in Tirhut also पत्तर *pattar*, and in South Bhagalpur मररो *marra*.

269. An iron ring is sometimes fixed under the block to prevent it being worn away by the crushing-pestle. This is generally सोरन्वार

morwār, with variants मोरवाह *morwah* (North-East Tirhut), मुकुवार *murwār* (Shahabad and Patna), मूर *mur* (Gaya), मुरेरा *murera* or मुकुवारी *murwāri* in South Munger, and चन्वा *chanwa* in Sāran. The पाचर *pāchar* or पापर *pāpar* is a round piece of wood placed in the bottom of the cavity, and on which the crushing-pestle moves. रोड़ा or रोर *rorā* is used for the smaller wedges of wood placed in the cavity above this to help in crushing the juice. These are also called चँदिया *chandiya* in Champāran and North-East Tirhut, and खोंच *khonch* to the east. In Sāran and Champāran रौन *raun* is a canal out on the surface of the block through which any juice thrown up may flow back into the cavity. In North-West Tirhut this is called रेन *rain*, in North-East Tirhut रसपैन *raspain*, and in South-East Tirhut खाना *khāta*.

270. The drain for the juice cut in the bottom of the block is to the north नरदोह *nardoh*; also in Tirhut नरोह *naroh*, in North-East Tirhut नरोही *narohi*, and in South-East Tirhut रसेर *raser*; in South-West Shahabad it is गुजुरवा *gujurua*, and in the rest of the district जोहा *joha* or रसवा *rasha*; in Patna it is रसवारा *rasghāra* or निरोह *niroh*; in Gaya it is छोनी *chhoni*; in South Munger, चोना *chona*; and in South Bhagalpur, लरलो *larlo*.

271. The wooden spout through which the juice drops is पतनारी *patnāri*. In the body of the block a channel is cut in which the block, फेंटा *phenta*, of the driving gear works. This is called घररा *gharra* in Shahabad and माँदर *māndar* in Patna.

272. *The horizontal board to which the bullocks are attached.*—This is कतरौ *katri*, with a variant, कातरि *kātari* or कातर *kātar*, in Shahabad, South-East Tirhut, and South Bhagalpur.

273. *The upright beam or pestle which moves in the hollow of the mill and crushes the cane.*—For this three names are current, viz. मोहन *mohan* (Tirhut, except the north-west, Champāran, Patna, and South Munger), with variants, महान *mahan*, in Gaya and North-West Tirhut, and माँहन *monhan* in Shahabad, लाठ *lāth* (Tirhut and Champāran), and जाठ *jāth* (Tirhut and Shahabad). The last word is used in Sāran only in reference to the oil-mill, and not to the cane-mill.

274. The ball at the end of this beam, which fits with the hollow of the block, is मूँर *mūnr*, मूँरा *mūnra*, मूँरी *mūnri*. The notch above this is north of the Ganges and in Patna काह *kāh* or कन्हा *kandha*. In North-West Tirhut it is कँहिया *kanhiya*, and in South-East Tirhut पन्जा *panja*. In Shahabad it is कान *kān* or लंगरा *langra*. In Gaya it is

मोहनम्बहा *mohanthambha*, and in South Munger डेंका *dhenka*. The upper end rounded off is चूर *char* or चुरिया *churiya*, or (in North-East Tirhut) मूँर *mūnr*; and the curved block of wood joined to this is डेंका *dhenka* or (in North Tirhut, Shahabad, and South Bhagalpur) डेंकुवा *dhenkua*, and in Sāran डेंकुवा *dhenkuha*. This curved block of wood connects the pestle with the upright post which is fixed in the horizontal driving-board.

275. This upright post is north of the Ganges, to the west, बरगडा *harsa* or हरिया *harisa*, and to the east (and in South Bhagalpur) मनिक्कथन *maniktham* or मनिक्क थन *manik tham*. In Shahabad it is मन्कथन *mankham*, in Patna and Gaya खूँटा *khūnta* or मरगथन *marthamh*, and मनिक्कथन *mānikham* in South Munger. The pieces of wood which keep the beam of the driving gear in the channel at the base of the block are जीभा *jibha* or जिबिया *jibhiya*, or in Sāran the front one is called फटा *phenta*, and the back one कनेह *kanail* or (south of the Ganges) कनेही *kanheli*, and in Sāran कनेही *kanaili*. In North-East Tirhut they are called जिबिया *jibiya*.

276. A rope of straw supporting the pestle by fastening it to the upright beam is north of the Ganges, to the west, नाधन *nādhān*, in Champāran नधना *nadhna*, in Tirhut नधान *nadhān*, but in East Tirhut लध *lādh*. In Shahabad it is टेंडना *tanrna*, in Gaya नाध बरगडा *nādh barta*, in Patna नाधन *nādhān*, in South Munger नाध *nādh* or बरगडा *barah*, and in South Bhagalpur सारंगी *sārangi* or लेधा *ledha*.

277. The bamboo strut attached to the horizontal driving-board, and running up obliquely to meet the upright post, is called north of the Ganges बरगडाड़ी *kharchānri*, or south of it कमोरा *kamora* (Shahabad), खंरचर *khanrchar* (also in Shahabad), खरचर *kharchar* or बरगडाड़ी *kharchāli* (Patna and Gaya), कुडंरिया *kudanriya* in South Munger, and खंरचारो *khanrchāro* in South Bhagalpur. This is fastened to the driving-beam by a rope, called नारन *nāran* or नाधा *nādhā*, or in East Tirhut लारन *lāran*.

278. The part of the horizontal beam on which the driver sits is कतरि *kātari*, कतर *kātar*, or कतरौ *katri* as above.

279. The leather thong by which this horizontal beam is connected with the yoke is नाधा *nādhā* or (in Sāran) कनेही *kanheli*, (in Gaya) नाधा बरगडा *nādhā barta*, and in Patna मंज्हा *mānjha*. काढ़ *kārh* or (in North-East Tirhut and Shahabad) काढ़ा *kārha* is a rope which is tied to a peg in the end of the horizontal board, passed round the hump of the bullock and back again to the board, where it is tied into a hole;

and the rope passing under the bullock's chest, joining the two traces thus made, is *पेटी peti*.

280. *Miscellaneous*.—The circle in which the bullocks move has various names, viz. गोरपौर *gorpaur* (Sāran), पौदर *paudar* (Champāran and Shahabad), पौर *paur* or पौरी *pauri* elsewhere north of the Ganges, in Patna, Gaya, and South Bhagalpur, बही *bahi* also in Patna, and बड़हरा *barhara* in South Munger.

281. The receptacle for the cane before it is cut (generally a hole in the ground) is गेंड़ियारी *genriyāri* generally, and गेंड़ियार *geriyār* to the west. The receptacle for cane ready cut is टोमियारी *toniyāri*, with variants टोमियाठी *toniyāthi* (Sāran, Champāran, and South-West Tirhut), टोमियाडी *toniyādi* (North-West Tirhut), and टोमन्नाद *tonkhād* (South Bhagalpur). In Shahabad it is called अंगरवार *angarwār*.

282. A wooden mallet is used for pressing the cane under the crusher. This is थापी *thāpi*; also in North-East Tirhut मिडिट *milit*.

283. The cane as it is crushed is stirred up by hand, and the man who does this is called मोरवाच *morwāh* or मौरवाच *monrwāh*, or in South Bhagalpur घनवाचा *ghanwāha*. This man sometimes drives the bullocks also, and when he does so he is still called by this name.

284. The pot into which the juice drops is called generally खोरा *khora* or (in South-East Tirhut) खेर *khor*, other local names being नाद *nād* (Shahabad) and कुन्दा *kunda* (Shahabad, West Tirhut, and Patna), or (generally) चन्ना *chhanna*. Over this is often placed a basket or earthen pot with the bottom pierced like a sieve. This is called generally चन्ना *chhanna*, रसचन्ना *raschhanna*, or च्हेनी *chheni*. Local names for this are तारौड़ी *tarauri* (Sāran and Champāran), चिहा *chhitta* (also in East Tirhut), or चिरगिरा *chhirhira* (Shahabad), and दलिया *daliya* (South Munger). An earthen vessel for holding the juice is in Gaya हथैला *hathaila*.

285. From these vessels the juice is removed to the boiler in a pot called कराच or कड़ाच *karāh*, or sometimes कराचा *karāha*.

286. The blocks on which the cane is cut are north of the Ganges and in Shahabad निसुचा *nisuha*, a variant being निसुचा *nisua* in South Bhagalpur. Other names are ठेचा *theha* (North-West Tirhut), परिथेठा *pariyetha* (Gaya), कुकाठ *kukāth* (Patna), परन्कठ *parkath* (South Bhagalpur), and टोमन्काहा *tonkatta* or टोमन्कट *tonkat* in South-East Tirhut and Munger.

287. The hollow in the mill is in Bihār cleaned by hand while the crusher is turning: hence there is no apparatus in existence for raising the latter, as there is in Gorakhpur and Āzamgarh.

288. The basket from which the mill is fed is चैंडी *chainti* north of the Ganges, with a variant, चीडी *chhiti*, in North-East Tirhut. In Shahabad it is चोड़ी *ori* (also in East Tirhut) or खैंची *khainchi*, and in South Bhagalpur चोड़िया *oriya*. In Patna it is बट्टा *batta*, and in Gaya पथिया *pathiya*. The pieces of cane cut up ready for the mill are गेंड़ी *genri* to the west and optionally in East Tirhut, and टोनी *toni* in Patna, Gaya, and to the east. In South-West Shahabad they are अंगारी *angāri*.

289. As much chopped cane as can go into the press at one time is गानी *ghāni*, and as much juice as can be boiled at one time ताव *tāv*. The latter is also खेषाव *khepān* in South-East Tirhut, पाक *pāk* in Patna, and राव *rāv* or राव्ह *rānh* in South Munger and South Bhagalpur.

290. The cane after the juice is expressed is called खोरवा *khoīya*, with local variants खोरिया *khohiya* (Patna, Gaya, and the east) and खोरवा *khoīha* in South Bhagalpur. In Shahabad it is also चेषुवा *chephua*.

291. To work the mill is घेरव or घेरव *perab*, and when several cultivators take it in turns, each turn is called भाँज *bhānj*, पारी *pāri*, or (Gaya) पल्लडी *palti*. When men work it turn by turn they are said to do it भाँजा सिरे *bhānja sire* north of the Ganges, घेरा पारी *phera phāri* in Tirhut, and elsewhere पारा पारी *pāra pāri*. Sometimes a mill is owned by co-sharers, and then their taking it in turns is भँजघरिया *bhānjhariya*, सजियेती *sajhiyāiti*, or (Tirhut) सब्ठेती *sabthāiti*, and also in North-East Tirhut सजिया *sajhiya*. In South Munger डेंक *dhenk* is the working of a mill by cultivators for a week in turn, one after the other, till the turn of the first comes again.

292. *The men engaged on the mill are as follows :—*

(1) *The man who cuts the standing cane.*—This man is अंगेड़ीरा *angerīha* to the west generally, गेंडवघिया *genrwahiya* in the north-west, पजुवावा *pajwāha* and पगरवाव *pagarwāh* or पंगरवाव *pangarwāh* in Tirhut. In Shahabad he is also गेंडकीडा *genrchhīla*, or in the south-west of the district खोलवा *chholwa*; in Patna and Gaya he is केतरपारा *ketarpāra* (from केतारी *ketāri*, sugar-cane), परन्नावर *partāhar*, or परन्निहार *parnihār*, and in South Munger कतरपारा *katarpāra* or पतरपारा *patarpāra*. In South Bhagalpur he is घुरकटा *ghurkatta* or कटनिया *kataniya*.

In Sāran and Champāran these men do their work without wages in money, their pay being the leaves of the cane which they cut, which they take home and use for cattle fodder.

293. (2) *The man who cuts the cane into lengths for the mill* is कानू *kānu* in South Tirhut and Sāran. In Champāran he is पकवाह *pakwāh*, and to the west he is गेंडिकाटा *genrikāta* or अंगरवाह *angarwāh*. Elsewhere he is टोककटा *tonkatta*, with a variant, डोककटा *tonikatta*, in South-East Tirhut. In North-West Tirhut he is simply called मजुरा *majūra*, and in North-East Tirhut sometimes ज्ञान *jān*. In Sāran and Champāran the same person cuts the cane and boils the juice, hence his name.

294. (3) *The driver of the mill* is कतरवाह *katarwāh*, with variants कतरिवाह *katariwāh* or कतरवाहा *katarwāha*, and in South Bhagalpur कतरवाहा *katarbaha*. In South-West Shahabad and in Tirhut he is called हंकवा *hankwa*.

295. (4) *The man who feeds the mill.*—He is मोरवाह *monrwāh* or मोरवाह *morwāh* generally. In Patna and Gaya he is घनवाहा *ghanwāha* or (in South Bhagalpur and South Munger) घनवाहा *ghanbaha*.

296. (5) *The man who removes the crushed cane.*—He is हलुआ *haluā* in North Tirhut; elsewhere this is done by the man who feeds.

297. *The buildings.*—The whole manufactory, including both cane-mill and boiling-house, is called कोलुहार *kolhuār*, or in South-West Shahabad गोलाुर *golaur*. In Patna, Gaya, and the east it is called कोलहार *kolsār*.

298. The house in which the cane is cut into slips for the mill is called गेंडिहार *genriyār*, or गेंडिहारी *genriyāri* to the west and टोनिहारी *toniyari* to the east. Local varieties of this last are टोनिहासी *toniyāsi* in North-West Tirhut and टोकवाह *tonkhād* in South Bhagalpur.

299. *Folklore on the subject.*—Near the place where the cane is cut into slips the men make a round idol of a deity called महार बीर *makār bīr*, or in Shahabad महार बीर *makkār bīr*, and in North-East Tirhut महार *makkār*. He is said to have been originally a Dom, who once came to a sugar manufactory in the olden time and asked for juice, which the people refused to give to him. Thereupon he jumped into the boiler and was boiled to death. His spirit became deified, and is now worshipped by the workmen. The worship consists in pouring a little water on the

image when the cane is brought into the manufactory from the field, so that he may wash himself. Then five canes are put before him. They are then cut up and put first into the mill. The first juice that comes out is also poured over him, and then the rest may go into the boiler. In South Bhagalpur the deity worshipped is *बिसुकरवा* *biswakarma*.

B.—THE BOILING-HOUSE.

300. This is in Sāran *गुरौर* *guraur*, and in Shahabad *गोखौर* *golaur*; elsewhere it is simply *कोलुवार* *kolhuār* or *कोसवार* *kolsār* as above.

301. The fireplace is *चूल्हा* *chūlha*, or in South Munger *गमणेर* *gamher*. The hole through which the fire is fed with fuel is generally *मुच* *muh* or *मुंघ* *munh*, but in Patna and Gaya it is *मोचन्हा* *mohkha*. The hole through which the fire is raked is *सांसी* *sānsi* generally north of the Ganges, *नांगड़ा* *nangra* in North-East Tirhut, *लंगड़ा* *langra* in Shahabad, and *उधान* *udhān* in South-East Tirhut. Elsewhere it has no special name. In Sāran *लंगड़ा* *langra* is a receptacle for the juice when removed from the boiling-pan.

302. The outlet for smoke is *धुआँकड़* *dhuānkas* north of the Ganges and in Shahabad. In South-West Shahabad it is *धुंधुका* *dhundhuka*, in Gaya it is *हिक्का* *hikka*, in Patna *हीक* *hink*, and *नेंगड़ा* *nengra* in South Bhagalpur and South Munger.

303. The stick used as a poker is *खोरनी* *khorni*, or in Patna *खोरना* *khorna*. Local names are *खोदीना* *khodauna* (South-West Shahabad), *लहवा* *lahwāi* (Shahabad), and *अँचना* *anchna* (to the east). In Shahabad *फरुही* *pharuhi*, or in the west generally *फहुरी* *phahuri*, is a piece of wood used for raking out ashes. The man who stokes the fire is called *कानू* *kānu* north of the Ganges and in South Bhagalpur and Shahabad. Local names are *धुरकमिया* *dhurkamīya* (South-East Tirhut), *चुलहोका* *chulhonka* (East Tirhut and Shahabad), *चुलहानचा* *chulhancha* (East Tirhut and Gaya), *अँचनवाहा* *anchwāha* (Patna), and *अँचनहार* *anchtāhar* (South Munger).

304. The vessel in which the juice is collected before boiling is *नाद* *nād* or *नादी* *nādi*, or (in Gaya) *चह्नी* *chatti*, (North-East Tirhut) *गगरी* *gagri* or *घैला* *ghaila*. Generally, however, it is kept in the *हन्ना* *chhanna* (see above), of which there may be several in use at one time.

305. The spoon for taking the juice out of the boiler is north of the Ganges, to the west, *कठही* *kathahi* or *कठखुरपी* *kathkhourpi*, and to the east (also in Shahabad) *सेक* *saik* or *सेका* *saika*. Elsewhere south

of the Ganges it is सफरं *sapharī* or सफेना *saphaiya*. In South-West Shahabad it is, however, डोहरा *dohra*, and in South Bhagalpur it is दपन्दी *dapti* or दबू *dabbu*.

306. The scraper to prevent the sugar resting on the bottom of the boiler is खुरपी *khurpi* generally. In Sāran and Champāran it is खुरपा *khurpa*, and in North-East Tirhut कठखुरपी *kathkhurpi*, the meaning of which here is different from that in Sāran, Champāran, and West Tirhut. In Patna it is पेदनी *perni*, and दपन्तन *daptan* in South Bhagalpur.

307. The iron ladle used as a skimmer पौना is *pouna*, or (North Tirhut) मैलच्छा *mailchhanna*, (South-West Shahabad and South Bhagalpur) थापी *thāpi* (also made of wood), and जंजरा *jhanjhra* in Patna, Gaya, and South Munger. Sometimes it is not necessarily of iron, and then it is खुरपा *khurpa* in South-West Shahabad, कथा *katha* or कथा *hattha* (of earthenware) in Patna, Gaya, and South Munger, and च्छाना *chhanauta* in Sāran and South Bhagalpur.

308. The boiling-pan is called कराह, कड़ाह *karāh* or कराही *karāhi*. The earthen vessel used for removing the cooked juice from the boiler is north of the Ganges सैक *saik* or सका *saika*, and in Shahabad it is पंगौरा *pangaura*; in Sāran it is पौंदा *pounra*. The pot in which the boiled syrup is placed is called मदकी *matuki* south of the Ganges, also (South-West Shahabad) ओड़ी *ori*, (Gaya) नदवा *nadwa*, खोरा *khora* in the South-East, and कुंड़ी *kūnri* in South Bhagalpur.

309. नाद *nād* is a hole in the ground dug for receiving the coarse sugar. North of the Ganges it is also पौंदा *pounrha* or पौंदी *pounrhi*. The sugar is collected and thrown into this with a bamboo fitted at one end with a roller, which is called गुरदम *gurdam* or (in South-West Shahabad) गुरदन *gurdan*. In Tirhut it is also called दबकन *dabkan*, and in South-East Tirhut सपरी *sapāi*.

310. In North-East Tirhut माट *māt* or कोठी *kothi* is the large vessel in which the juice is finally coagulated. These are in Tirhut गुरपीर *gurpaur*, and in Champāran (made of sun-baked earth) डोहरी *dohri*.

311. राब *rāb* is undrained raw sugar, and गूर *gūr* is *rāb* boiled down for a longer time. Further particulars concerning these and the other products will be found in the chapter relating to sugar-cane (§§ 1014, 1015).

O.—THE SUGAR REFINERY.

312. A sugar refinery is known as चीनी के कारखाना *chini ke kar-khāna* or चीनी के गोदाम *chini ke godām*. South of the Ganges the word खंवर *khanrātr* or खंवरारी *khanrātri* is also used. The house in which the sugar is refined is called चूल्हा के घर *chūlha ke ghar* or कारा के घर *karāh ke ghar*. In South Bhagalpur it is बड़ा *bhāttha*.

313. In making coarse sugar (काँची चीनी *kānchi chīni*), a vat, a drain, a reservoir, and a treading-floor are used.

314. The *vat* is in Shahabad चौद *haud* or चौरी *haudi*, in Gaya चबन्धा *chahbachcha*, in Patna खंवरगना *khanrgarna*, and in South Bhagalpur गुरन्धी *gurhandi*. North of the Ganges and in Gaya it is नाद *nād* or नाँद *nānd*.

315. The *drain* is नाली *nāli* or नारी *nāri*, or in South Bhagalpur करन्धा *karha*. In Sāran it is also called खाता *khāta*.

316. The *reservoir* is north of the Ganges, and optionally in Shahabad, नाद *nād* or नाँद *nānd*. In Shahabad it is डोबा *dobha*, in Patna चौद *haud* or चबन्धा *charua*, and elsewhere south of the Ganges चबन्धा *chahbachcha*.

317. The *treading-floor* is पटा *patta* north of the Ganges. South of it, it is in Shahabad पाटा *pāta*, in Patna and Gaya चबन्धा *chabuttra*, and to the east चट्टी *chatti*.

318. In making regular sugar or सक्कर *sakkar*, the drain and the reservoir are used as before. The bundles (मोटरी *motri*, or in Patna नारंगी *nārgi*, in Gaya थैया *thaiya*, and in South Bhagalpur गाजा *gōja*) of sugar are tied up in cloths [डोबा *lotha* or (in Patna and Gaya) चहना *chhalna*], placed on a bamboo framework and pressed with weights of stone or sun-dried clay. The framework is called north of the Ganges खँच *khānch* or खँचा *khāncha*, or (in Champāran and East Tirhut) हँटा *chhainta*. In Shahabad it is डटरी *thatri* or टिकन्डी *tikthi*, in Patna and Gaya टेकन्डी *tekthi*, and in South Bhagalpur चँचरी *chānchri*. The weights are चँपा *chāmpa*, or, when made of stone, पथल *pathal*, or in Sāran थापी *thāpi*.

319. The following *utensils* are used in the boiling-house:—

- (a) An iron boiler, कारा *karāh*, काराहा *karāha*, or काराही *karāhi*. When an earthen boiler is used, it is called खपड़ा *khapra* or खपड़ी *khapri*, or in South-West Shahabad and East Tirhut अथरी *athri*.

- (b) An iron ladle for removing the scum. This is चमौटा *chhanauta* or पौना *pauna*, also in Patna and Gaya जंजरा *jhanjhra*.
- (c) An earthen pot with holes in it, used as a filter, नार *nād* or नारंद *nānd*. In South-West Shahabad it is ठेंडिवाळ नार *thenthīwāl nād*.
- (d) A filter of river grass, known as सेवार *semwār* or सेवार *sewār*, or in North-East Tirhut सेमार *semār*.
- (e) A scraper for removing the layer of clean sugar. When made of shell it is called सिनुषा *situa*, or in South-West Shahabad सिनुषा *situha* or सुनुषा *sutuha*. A curved knife used for the same purpose is सिहोरनी *sihorni* in Sārān and Champāran, सेहोरना *sehorna* in Shahabad, and सोहरना *sohurna* in North-East Tirhut.
- (f) The filtering-basket for cleaning the same is खँचा *khāncha* or खँची *khānchi*. In Gaya it is डलवा *dalwa*, and in the east also डेली *deli*.
- (g) The wooden or iron ladle for cooling the boiling syrup is north of the Ganges तामिया *tāmiya* or (in Sārān and North-East Tirhut) तमिया *tamiya*. South of the Ganges it is डब्बू *dabbu*, (in Shahabad) गुरगुन *gurdan*, or in South Bhagalpur जंजरा *jhanjhra*.
- (h) The iron stirring ladle used for taking syrup from the boiler and larger than the last is तामा *tāma* north of the Ganges; in Shahabad it is खुरचनी *khurchani* or दोहरा *dohra*; in Patna and Gaya it is चोहनी *chholni*; and in South Bhagalpur दोहरा *dohla*.
- (i) The earthenware jug for pouring the syrup into the boiler is सैका *saika*, also हत्था *hattha* in Patna and Gaya, and पंचनी *panchni* in South Bhagalpur. A larger jug of the same kind is निमड़ा *nimra* north of the Ganges, and निबड़ा *nibra* or परखा *parchha* south of it; also तौला *taula* in the east.
- (j) The wooden supports of the filter are north of the Ganges खता *khāta*, or खूँटा बख *khūnta balla* south of the Ganges. They are in Shahabad सिर्ही *sirhi* (also in South Mūnger) or तिरपार *tirpāi*, and टेपार *tepāi* in South Bhagalpur. In Patna and Gaya they are made of earth or brick, and are called गोड़ी *gori*.

- (k) The shovel for stoking the fire is फरुही *pharuhi* or फहरा *phahura* in Sāran and Champāran, and फरुहा *pharuha* or कोदारी *kodāri* in East Tirhut. In Shahabad it is फरुमा *khorma*, or in the south-west of the district फरुसा *pharsa*. In Gaya it is फरुनी *karhni*, in Patna फरुमा *agkarhna*, and in the east फरुहुल *karchhul*.
- (l) The ladle for stirring the hot syrup in the cooling pan is तमियाँ *tamiyān* north of the Ganges and तमिया *tamiya* in Shahabad. In South-West Shahabad it is डबू *dabbu*, in Patna and Gaya घटना *ghatna*, and in the east also दाबा *dāba*.
- (m) The piece of matting or cloth in which the sugar is dried in the sun is पाल *pāl*, also in South-West Shahabad पाटा *pāta*, in Gaya टप्पर *tappar*, in Patna टाट *tāt*, and in South Bhagalpur चट्टी *chatti*.
- (n) The flat wooden pans for cooling the syrup are कठौता *kathauta* or कठौती *kathauti*, also in the east कठौत *kathaut*, and in Sāran कठवत *kathwat*. In Sāran and Champāran they are नाद *nād* or ओसौनी *osauni*.
- (o) The vessel into which the juice drops as it is filtered is फरुसा *parchha* or (North-East Tirhut and Shahabad) तौला *taula*.

CHAPTER III.—APPLIANCES USED IN THE MANUFACTURE OF INDIGO.

320. Indigo manufacture is confined almost entirely to North-Gangetic Bihār.*

321. The indigo beating-vat is महार के चौद (or चौद) *mahāi ke hauj* (or *haud*), and also in North-East Tirhut महानिया चौद *mahaniya haud*. The water reservoir is खजाना *khajāna*. The upper or steeping-vat is बोहार के चौद *bojhāi ke haud*, or in East Tirhut बोहनिया चौद *bojhaniya haud*. The rake for agitating the fermented liquor is फरुही *phahuri* in Sāran and फरुहा *pharuha* elsewhere. In North-East Tirhut it is also फरुमा *pharma*.

* The author is indebted to W. B. Hudson, Esq., for much of the information contained in this chapter. The system of manufacture described is the old style, now only used by natives. In European factories the use of steam power has made considerable changes.

322. The beams of wood for pressing the plant are दबौटा *dabauta* in Sāran and Champāran, सख्तनीर *saktir* in Tirhut and Sāran, दाब *dāb* or धरन *dharan* in North-East Tirhut, and बीम *bim* in South-East Tirhut. These are supported on projections in the walls of the vat, called मजुसी *majusi*, or in Champāran तान *tān*. In East Tirhut they are called सिरपाहा *sirpāha*. Under these pressing-beams are placed, बाला *ballal*, or in Sāran कैच *kainch*, which are bamboos laid immediately on the top of the plant.

323. The हौदरी *haudri* (Sāran and South Tirhut) or माल कढ़ी *māl jhari* (Champāran and North Tirhut) is the small reservoir where the indigo juice collects to be taken to the boiler. The drain is नाली *nāli* or नारी *nāri*, or in Sāran मोरी *mori*, and the डेकन *chhekan* is the door by which it is closed. The strainer is चन्ना *chhanna*, or in South-West Tirhut चद्दर *chaddar*.

324. The boiling-room is क़राह घर *karāh ghar*. The मेज *mej* is the wooden or masonry straining table in which the indigo is put after being boiled. This is the name in Sāran, Champāran, and West Tirhut; to the east it is बाहु मेज *bāhu mej* or (in South-East Tirhut) माल मेज *māl mej*.

325. The पीरिच *pīrich* or पीरिस *pīris* is a corruption of the English word "press," in which the boiled liquor is placed in a cloth and the water pressed out. In Sāran दाला *dāla*, and elsewhere चखना *chalna*, are the perforated boards placed above and below the indigo in the press. The screw of the press is पेंच *pench*. The square boss or nut on it is दिबरी *dhibri*. The मोरनी *morni* is the spanner or apparatus for turning the screw. In South-East Tirhut it is also ममोरनी *mamorani* or पेचकस *pechkas*. The large wooden beam through which the screw passes is थेहा *theha* in Sāran, and elsewhere दबौटा *dabauta* or दाब *dāb*; when it is made of iron it is called in South Tirhut बाँक *bānk*. The कुटका *kutka* are small pieces of wood placed below and above the दाला *dāla* or चखना *chalna*.

326. The machine for cutting cakes is फरना *pharma*, and the wires with which they are cut तार *tār*.

327. The cakes of indigo are गोटी *goti*, and they are dried in a drying-house, गोटी घर *goti ghar*, on shelves, called in East Tirhut मचान *machān*, and elsewhere चाही *chāhi*.

328. The following are among the implements used in indigo agriculture :—

- (1) The धर्म लगी *dharm laggi*, a wheel for measuring land, each revolution of which covers one लगी *laggi*.
- (2) The कुदर *kudār* or कुदरि *kudāri*, a mattock for digging.
- (3) The हार *har* or plough, which is of two kinds—
 - (a) बिलैती *bilāēti*, or English plough.
 - (b) देसी *desi* or कठौर *kathaur*, the country plough.
- (4) तंड़ी *tānri*, the drill plough.
- (5) कटा *kanta* or खोरणी *khakhorni*, the rake or harrow.
- (6) खुरपी *khurpi*, the spud for weeding.
- (7) हंसु *hānsu* or हंसुवा *hānsua*, the sickle for cutting the plant.

CHAPTER IV.—THE SPINNING-WHEEL.

329. The following diary shows the process of spinning thread and making cloth in the subdivision of Madhubani, in North-East Tirhut, in the year 1879 :—

On the 20th September the writer bought 24 *seers* of cotton, being a day's plucking on a sunny day from about a bigha and a half of cotton field. The cotton बाँगा *bānga* (see § 1016 for the various names and varieties) was of the kind called कोकटी *kokti*, which ripens in the month of *Bhādon* (August–September). It was pulled out of the husks from the tree.

20th—26th September.—During this time the cotton has been drying in the sun, and now (26th) two old women are employed to clean it, picking out the dirty and immature cotton, called कर्कट *karkut*. This is principally composed of seeds which have come to nothing and been worm-eaten. This cleaning is done by hand. It lasted to the 30th September.

1st October.—Commenced to separate the seeds, बंगौर *bangaur*, from the बाँगा *bānga*. This is done by a machine called चरकी *charkhi*, which consists of two rollers, about an inch thick, of hard wood tightly wedged one above the



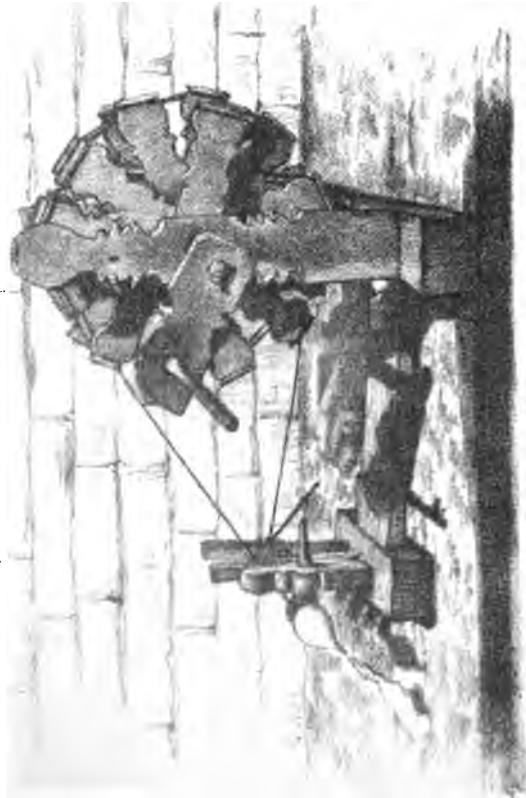

THE SPINNING-WHEEL (CHARKHA).

Lith. by Bepin Behary Das, Student Govt. School of Art, Calcutta.

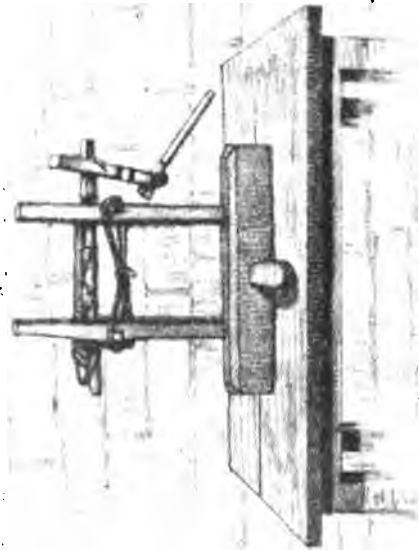

MACHINE FOR CLEANING RAW COTTON (CHARKI).

Printed by Abdoel Rehim Govt. School of Art Calcutta.

other; both rollers are supported in uprights, the ends passing through. At one end the lower roller is turned by a handle, and has at the other end, where it projects from the upright, a screw cut in it. The same end of the upper screw has a reversed screw cut in it, and these two screws fitting into each other act like cog-wheels; but when the lower roller is turned, the upper roller turns in the direction reverse to that of the lower one, so that they act as a pair of feeders tightly wedged together. The **बाँगा** *bānga* or uncleaned cotton is then applied to the feeding side of the two rollers, and on the handle being turned the cotton is pulled forcibly through by their revolution, while the seeds remain behind and fall down to the ground.

330. The two upright standards are called **खूँटा** *khūnta*, and each of the rollers **जाडि** *jāṭhi*, or in Saran **सँवारी** *sanvāri*. Underneath the rollers is a cross-bar, called **बल** *kal*, joining the two uprights and holding the machine together. The **खूँटी** *khūnti* is a wedge going through each upright from front to back, under the cross-bar and holding it and the roller in their places.

331. The **पचरी** *pachri* are the wedges running sideways through each upright and tightening the two rollers together. The crank which turns the lower roller is called **मकरी** *makri*, and it is held to it by the **किळी** *killi* or lynch-pin. The handle at the other end of the crank, which is held in the hand, and by which the machine is turned, is called **लागनि** *lāgani*, or in Saran **चलौनी** *chalauni* and in Gaya **बचौरी** *bathauri*.

332. The base of the machine in which the uprights rest is called **पीरहा** *pirha*, or to the west **पिहिवा** *pirhiya*, and out of this projects behind, along the ground, the **मज्जा** *majhwa*, on which the foot of the operator is placed to keep the machine steady.

333. The cotton, when cleaned from the seeds by this machine, is called **रू** *rū*, **रूँ** *rūi*, or **तूर** *tūr*,—the last by women of the upper Hindu castes, and the two first by Musalmāns and low-caste Hindus. **रूँ** *rūi* is used in Shahabad.

334. The above lasted three days. It was then again cleaned (**तूनब** *tūnab*, **तूनब** *tūnab*, or (in Shahabad) **तूमब** *tūmab*, to clean), the few remaining pieces of husk, &c., being picked out by hand.

21st October.—The cotton was to-day put out in the sun preparatory to being carded (घुनव *dhūnab*, to card).

22nd October.—To-day two cotton-carders (घुनिवा *dhuniya*) came to card the cotton. Each brought with him a machine, called a घुनकी *dhunki*, or to the west धनुही *dhanuhi*. In Gaya it is घुनेठी *dhunethi*, in South Munger and South-East Tirhut घुनेठ *dhunaith*, and in South Bhagalpur घुनहठ *dhunhath*.

335. It is composed of the following parts :—

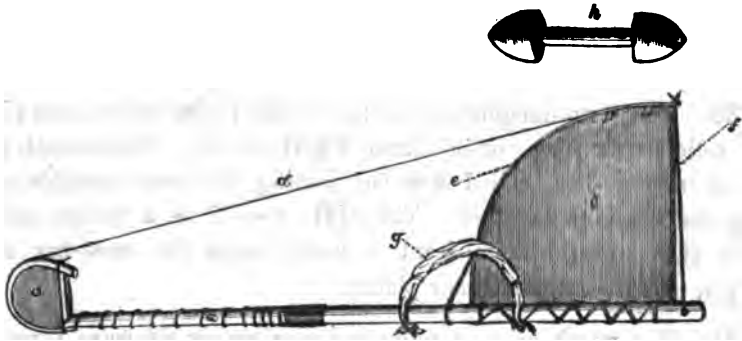

- (a) The flexible piece of wood acting as a bow, called दन्ती *danti* or दन्टा *danta* to the east and दन्ड़ी *dānri* to the west.
- (b) A broad wooden board, called फरेहा *phareha* in North-East Tirhut. In South-West Tirhut it is फरौटा *pharauta*, in South Bhagalpur फरुहा *pharuha*, and elsewhere as फरहा *pharha*.
- (c) The bridge over which the string is passed, मँगी *māngi*. In Shahabad and also optionally in East Tirhut it is माथा *mātha*, in South Bhagalpur मथवा *mathwa*, and in South Munger मगवासी *magwāsi*.
- (d) A leather string, called तँत *tānt*. In Patna and Gaya it is also called रोदा *roda*.
- (e) A leather strip acting as a sounding board, lying along the round edge of the फरेहा *phareha*, on which the string rebounds, called पुछेठ *puchhet* or पुछेटा *puchheta* generally,



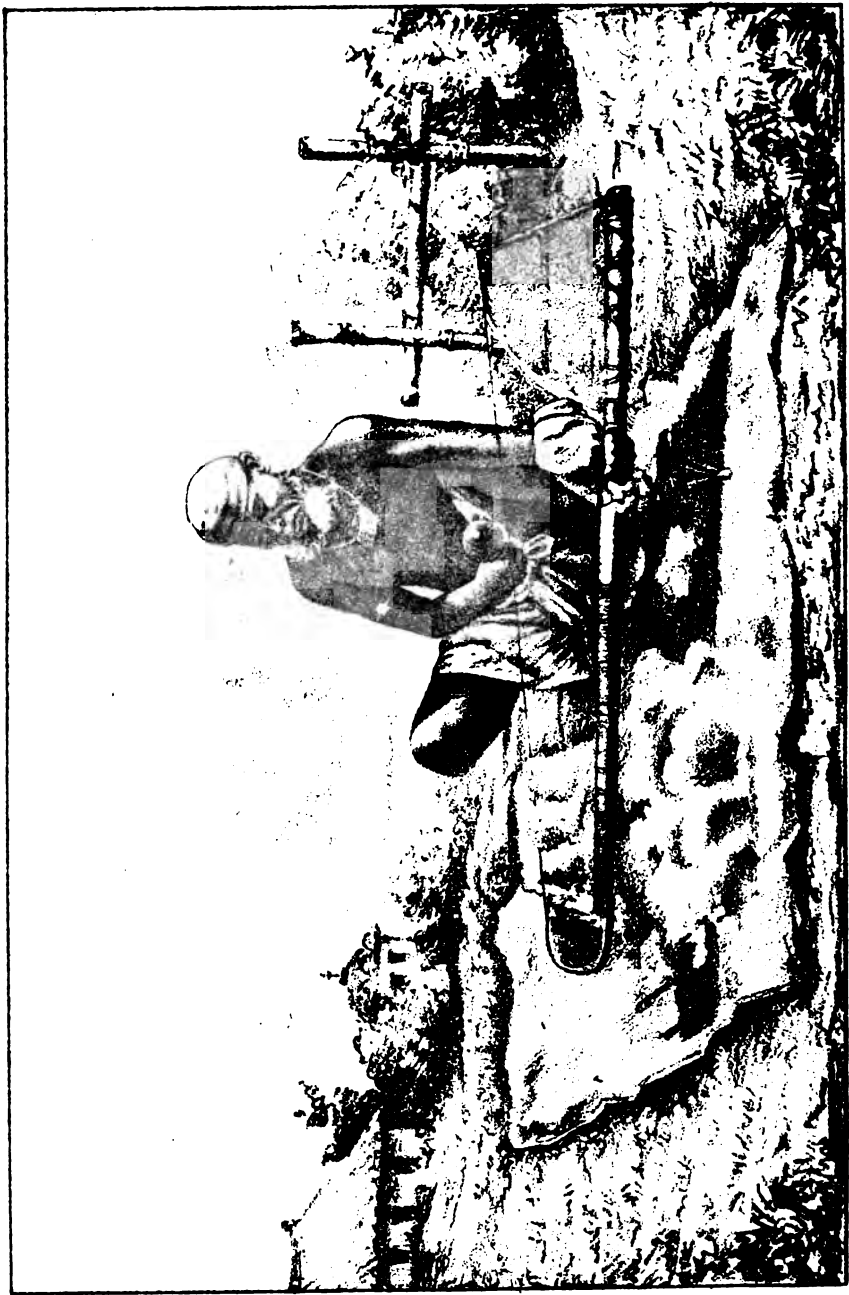

A Cotton-carder (Dhusiya) at Work

पक्षौडा *pachhauta* in Tirhut, and कंकार *kankar* in Sāran and Champāran. In North-East Tirhut it is पुश्तल *pushtail*, and an optional name in Shahabad is पुक्षौडा *puchhauta*.

- (f) A stout leather string along the outer side of the फरेहा *phareha*, to one end of which the तान *tānt* is attached, while the other end is fastened to the दन्डी *danti*. It is used to tighten the तान *tānt*, and is called गिरची *ghirchi* or घुरची *ghurchi*. When pegs are used for tightening this, they are called बीरी *biri* or बिरिया *biriya*.
- (g) The हथकर *hathkar*, हथगर *hathgar*, or हथकर *hathkar*, is a loop of string under which the left hand is passed to hold the machine steady. The above is the name current in North-East Tirhut. South of the Ganges it is also called हथकर *hathkar*, with variants हथकर *hathkar* or हथकर *hathkara* in Shahabad. In North-West Tirhut it is हथरा *hathra*, in South-West Tirhut and Sāran हथा *hathā*, and in Sāran and Champāran मुठवारा *muthwāra*.
- (h) The mallet for twanging the bow, of wood, shaped like a dumb-bell. It is held in the right hand, and the तान *tānt* is struck and twanged with it. It is called जिस्ता *jista*, and also (in Tirhut and South Bhagalpur) दिस्ता *dista*. In Patna it is called दस्ता *dasta*, and in South Munger दिस्ता *distha*.

336. In using this instrument it is held by the left hand under the हथकर *hathkar*, which passes over the wrist, and the तान *tānt* twanged in the midst of the cotton by the जिस्ता *jista*, which is held in the right hand. This process loosens the texture of the cotton, and causes all the dust and dirt to fly out of it. The धुन्की *dhunki* is not allowed to rest on the ground, but is supported in the air by the हथकर *hathkar* passing over the wrist, and it springs up and down as the तान *tānt* is twanged.

337. The whole pile of cleaned cotton was called गोठी *gothi*. While this was going on, two old women were called in to make little hollow rolls of cotton to be made into thread. They are called to the east पीनी *pīni*, and to the west पिचनी *piṇi* or पेवनी *pevni*. A local name in East Tirhut is पीर *pīr*. These are about four inches long and a quarter of an inch thick. A lump of clean cotton, the size of a walnut, is put round a thin skewer, called पिंहरि *pinrḥari*, and is then rolled on a board, called पिदिहा *pirhiya*, with the palm of the hand. These are then tied up in bundles of about ten each, called मुठी *mutthi*.

338. These पीनी *pīni* are now ready for being made into thread in the spinning-wheel.

339. The spinning-wheel is चरखा *charkha*, but in South-West Shahabad it is राखा *rahta*, and in the south-east जरखा *jarkha*.

340. Its parts are as follows :—

The foundation.—This is in the shape of a double letter T : thus—

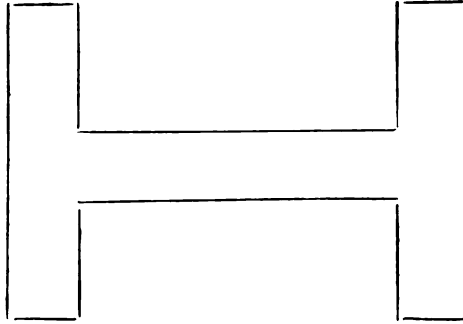

341. On one of the cross-pieces the driving-wheel stands, and on the other the spinning apparatus. This foundation is called पीड़ा *pirha* or पिदिवा *pirhiya* to the east, and पिहर *pirhar* to the west. The connecting bar between the two cross-pieces is मंजवा *manjhwa* or मंजा *manjha*, in Patna and Gaya it is लखोरा *lakhora*, and in South Bhagalpur मजहार *manjhāi*.

342. *The driving-wheel.*—The supports of the driving-wheel are called खूंटा *khūnta*. The wheel itself is composed of two parts,—

- (a) The central boss or nave, and
- (b) The four spokes on each side of the nave.

343. The nave is called मूँरी *mūnri* or मूरी *mūri* south of the Ganges, and मूँरी *mūnri* or मुँरिया *munriya* north of it; in East Tirhut it is also तामा *tāma*, and in South Bhagalpur and South Munger पैला *paila*. It is about 5 inches long and 4 inches thick.

344. There are four spokes lying across each end of the nave from one circumference to the other; there are therefore eight radii on each side, and they are so arranged that the radii on each side are not opposite each other, but alternate. Each of these cross spokes is called पुत्ती *putti* or पूती *pūti*, or in South-West Shahabad कमरी *kamri*; sometimes they are also called खूंटा *khūnta* or खूंटी *khūnti*.

345. These spokes are held in their places by a string, called **बनाह** *awāl* to the west, **बौनाह** *amwāl* in Patna and Gaya, and **बनाह** *amāl* or **बनाह** *amālh* to the east. In South Munger it is **बनाह** *amhāl*. This string goes round the extremities of each radius of each side alternately: thus—

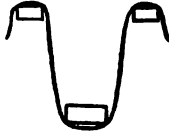

It forms therefore a kind of edge or rim of a broad wheel, something like a paddle-wheel, and over it passes the driving-band which turns the spinning apparatus. This paddle-wheel is about a foot in diameter and five inches thick.

346. The central axle of the driving-wheel is called **जाठ** *lāth* generally north of the Ganges and in South Bhagalpur. In Tirhut it is called **जाठ** *jāth*, and in North-East Tirhut also **जारठ** *lāith* or **जारठ** *jāith*. South of the Ganges it is generally **बेहना** *belna*. It is caused to revolve by a crank end called **मकरी** *makri*, or in Shahabad and West Tirhut **नाक** *nāk*. It is **दाही** *darhi* or **दहिया** *darhiya* elsewhere south of the Ganges, except South Bhagalpur, where it is again **मकरी** *makri*. To this is attached a handle, called to the west and in Gaya **चलौना** *chalauna*, and to the east **लरना** *larna* or **लरानि** *lārani*. In South-West Shahabad it is called **भौंती** *bhaunti* or **भौंन** *bhāmwat*, and in Saran optionally **चलौनी** *chalauni*.

347. The driving-band is called **नाह** *māl* or **नाह** *mālh*. It is rubbed with rosin (**धुमन** *dhūman*) and oil (**तेल** *tel*), and is then blackened with charcoal (**कोयला** *kōela*). The driving-band goes twice round the driving-wheel and the spinning-axle, once passing through the **मककाठी** *malkāthi* (*vide post*), and once not.

348. The spinning apparatus.—We now come to the spinning apparatus. There are three perpendicular uprights. The two outside ones are called **खंटी** *khānti*, and the middle one is called **मककाठी** *malkāthi*. In Patna these three uprights are called together **पचकठिया** *pachkathiya*, and in South-West Shahabad **खुंटिपुत्ती** *khuntiputti*. The two outside ones support the bearings of the spinning-axle, and the

centre one has in its length, facing the driving-wheel and going right through its thickness, a long slot out. One of the strings of the driving-band passes through this slot, and the other passes outside it, so that the double turn round the spinning-axle can never get jammed up together, and so entangled.

349. On the two outside uprights, on the side furthest from the driving-wheel, project two stiff pieces of leather, called चमरक *chamrakh*. These form the bearings of the spinning-axle, which passes through them.

350. *The spinning-axle.*—This is called टकुआ *takua*, and also to the west टेकुआ *tekua*. It is an iron skewer about 8 inches long and an eighth of an inch thick at the thickest part. It projects a distance of three inches beyond its bearing on the same side as the handle of the driving-wheel. This bearing has on each side two little pieces of wood fitting on to the spinning-axle, which act as washers, and are called चुचो *chhuchchhi*. Outside the outer washer on the spinning-axle is a flat disc called फिरकी *phirki*, and two and a half inches of the axle project beyond it.

351. The driving-band, after passing twice round the driving-wheel, passes through the मलकाठी *malkāthi*, then twice round the spinning-axle, and then back to the driving-wheel outside the मलकाठी *malkāthi*; and it is evident that even the slow turning of the driving-wheel will make the spinning-axle revolve at a very high speed indeed.

352. In spinning, the projecting point of the spinning-axle has a short length of thread attached to it, and then, while the handle of the driving-wheel is turned with the right hand, a roll of cotton (पीनी *pinī*) is held in the left hand between the finger and thumb, and the cotton, being quickly caught up by the length of thread, is drawn off in the shape of thread on to the quickly revolving spinning-axle.

353. When the projecting point of the spinning-axle is filled with thread, the whole is called a कुकरी *kukri*, or in Saran कुकुदो *kukurhi*, and is wound off on a winder, called परना *parta* or परेता *pareta*. It is also called in South-West Tirhut नटना *nata*, and in East Tirhut लटना *latwa* or नटना *natawa*. In South Bhagalpur it is called नटा *nata*. This is like an ordinary silk-winder. The handle (चालना *chalauna*) of the driving-wheel is taken out of its socket in the crank (मकरी *makri*), and in its place is placed one end of the axle of the winder. The other end is held in the right hand, and is revolved between the finger and thumb. The winder

is conical in shape, and does not need further description. It will hold half a quarter of a *ser* of thread at a time. When it is filled, the thread is taken off and tied in hanks. These are generally पोडा *pola*, पोडी *poli*, or पोडिया *poliya*. Local names are नत्ती *natti* (North-East Tirhut), लत्ती *latti* (Patna and Gaya), and करची *karchi* in South-West Shahabad.

354. The diary breaks off here temporarily, as the spinning of this particular cotton was not done in the writer's presence. He wished the thread to be spun as fine as possible, and as this could only be done by Brāhmani women, who would not come to a strange house, this part of the work was done by them at home.

CHAPTER V.—THE WEAVER'S LOOM.

355. The following is a continuation of the same diary.

18th January 1880.—The skeins of fine thread were brought to me to-day, and were put in water to soak for eight days. This strengthens it.

27th January.—After they had soaked this period I sent for a weaver. A Muhammadan weaver is जोडावा *jolha* or मोमिन *momin*, and a Hindu weaver is तंतवा *tantwa* or तंतो *tanti*, or, in Shahabad तंतो *tanto*. Sometimes the Hindi word जोडावा *jolaha* is used instead of जोडावा *jolha*.

356. The Musalmān weaver or जोडावा *jolha* is the proverbial fool of Hindu stories and proverbs. He swims in the moonlight across fields of flowering linseed, thinking the blue colour to be caused by water. He hears his family priest reading the *Qurān*, and bursts into tears to the gratification of the reader. When pressed to tell what part affected him most, he says it was not that, but the wagging beard of the old gentleman so much reminded him of a pet goat which had died. When forming one of a company of twelve he tries to count them, and finding himself missing wants to perform his own funeral obsequies. He finds the rear peg of a plough, and wants to set up farming on the strength of it. He gets into a boat at night, and forgets to pull up the anchor. After rowing till dawn he finds himself where he started, and concludes that the only explanation is

that his native village could not bear to lose him, and had followed him. If there are eight weavers and nine *hukkas*, they fight for the odd one. Once on a time a crow carried off to the roof of the house some bread which a weaver had given his child. Before giving the child any more he took the precaution of removing the ladder. Like the English fool, he always gets unmerited blows. For instance, he once went to see a ram fight and got butted himself, as the saying runs:—

करिगह चारु तमासा जाय
नाहक चोट जोहासा बाय.

Karigah chhar tamāsa jāy,
Nāhak chot jolāha khāy.

—‘He left his loom to see the fun, and for no reason got a bruising.’ Another story (told by Fallon) is, that being told by a soothsayer that it was written in his fate that his nose would be cut off with an axe, the weaver was incredulous, and taking up an axe kept flourishing it, saying *बाँ करणा तः जोड़ कांड-बाँ, बाँ करणा तः बाय कांड-बाँ, बाँर बाँ करणा तब ना-*, *yon karba ta gor kāṭbon, yon karba ta hāth kāṭbon, aur yon karba tah nā-*,—if I do so I cut my leg, and if I do so I cut my hand; but unless I do so my no—, and his nose was off. A proverb *जोहना जानथि जा काटे jolha jānathi jāu kātai*,—does a weaver know how to cut barley,—refers to a story (in Fallon) that a weaver, unable to pay his debt, was set to cut barley by his creditor, who thought to repay himself in this way. But instead of reaping, the stupid fellow kept trying to untwist the tangled barley stems. Other proverbs at his expense are *जोहा चाल बस केँ, जोहना चाल बाय केँ kaua chatal bās ken, jolha chatal ghās ken*,—the weaver went out to cut grass (at sunset), when even the crows were going home; *जोहना बुनिएहाँ तौषी खेत jolha bhutiaihā tōṣī khet*,—the weaver lost his way in the linseed-field, an allusion to the swimming exploit already recorded. His wife bears an equally bad character, as in the proverb *बाहसलि जोहनि बापक हाँदी मोचे bahsali jolhini bāpak dānrhi noche*,—a wilful weaver’s wife will pull her own father’s beard.

357. The weaver proceeded to set up in the ground seventeen pairs of sticks in two lines, at a distance between each pair of about one and a quarter cubits, and between the lines of about two cubits. At each end of each line a stout bamboo post is fixed, and close to each of

those at one end another smaller staff. Round these sticks the thread is twisted as follows :—

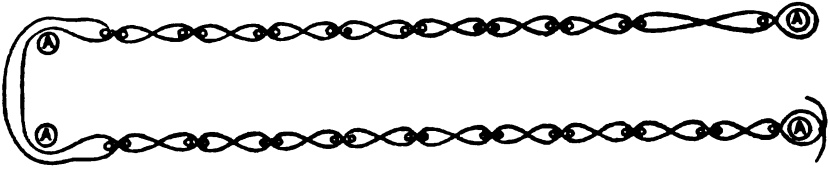

A, A, A, A, are the tops of the bamboo posts, and the dots are the tops of the smaller sticks.

358. This operation of setting the warp is called तानी करव *tāni-karab*, or in Shahabad ताना करव *tāna karab*. The bamboo posts are called खूंटो *khūnti*, and each stick, सर *sar*. These last are called in Sāran, Champāran, and North-West Tirhut सरका *sarka*.

359. The sticks immediately in front of the bamboo posts are called to the west चिट्ठा *chhitua*, in Shahabad चिपन्की *chhipki*, and to the east चिट्ठी *chhitki*, also in North-East Tirhut जोरीक सर *dorik sar*. The whole apparatus is called तानी *tāni*, or in Shahabad ताना *tāna*, and the thread to be stretched is put on a kind of pyramidal reel called चरन्की *charkhi*. It spins on a spindle, called दगन्गी *dagni*, or in Shahabad दंगी *dāngi*, and in the inside of the apex of the cone is a cup called थोड़ी *thori*, or in Shahabad थोड़री *tholri*, in South Munger थोड़की *thorki*, and in South Bhagalpur तोड़े *toi*, which rests on, and revolves on the point of, the spindle: thus—

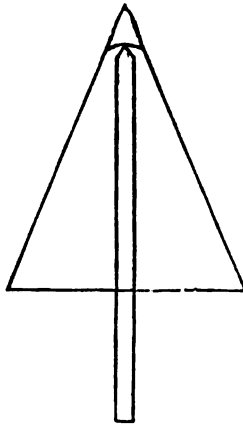

360. The spool is composed of 14 slips of bamboo, forming the framework of the cone, fastened at equal distances round the circum-

ference (चक्र *chakkar*) of the base of the cone, and converging to a point at the top.

361. The spindle of the spool is held in the left hand, and the weaver walks up and down between the two lines of thread, directing the thread by a hook called खूंड़ी *khūnri* or खोंड़ी *khonri*, or in South-West Shahabad खुडा *khunda*, in South Munger खुडी *khundi*, and in North-East Tirhut and Shahabad खूंरा *khūnra*, and shaped as follows:—



The hook at the top is made of iron.

362. 5th February 1880.—The warp having now been all set upon the sticks (सर *sar*), they were, with the खूंटी *khūnti*, pulled up, rolled up, and put by till to-day. To-day they were unrolled and laid out in a long line on the grass. The खूंटी *khūnti* were then carefully drawn out, and a bamboo staff, called सिरार *sirār* (or सिरारि *sirāri*), put in the place of each. It will be remembered that the सर *sar* were in pairs, and that at each pair the thread crossed thus



Another kind of सर *sar* is now taken, made like a long shallow bow, except that the string is made of a thin strip of bamboo. This bow is called सुतरी *sutri*, or in Tirhut बन्हा *banhka*. The arch of the bow is also made of bamboo. The bamboo string is called डोरी *dori*. The arch of the bow is now passed through the threads where one of the old सर *sar* was, and the bamboo string through where the other सर *sar* of the pair was, so that the cross of the threads is still preserved. The bow and string are then fastened to each other at

each end. The arches of the various bows all face one way. The warp is then laid out on the ground, and the threads neatly spread out upon the bows in parallel lines, to the width of the future piece of cloth.

362A. *9th February.*—The thread thus arranged was rolled up, dipped into, and well wet with cold rice-water (मॉद *mānr*), to which some मरुवा *marua* seeds had been added to stiffen it. It was then unrolled and stretched out horizontally at a height of three feet from the ground and brushed with a large brush, called कुंच *kunch*, dipped in mustard oil and water, which smooths the threads and takes away any knots or inequalities in the thread. This brush is also called मजना *majna* in West Tirhut, मॉजा *mānja* in South Bhagalpur, and मॉजन *mānjan* in South-West Shahabad. The cross sticks on which the thread rests are called मॉजा *mānjha*, and the cross bamboos at each end are डेंगनी *thengni* or लाठी डोर *lāthi dor* to the west, गोड़ा *gora* to the east, खसरैया *khasraiya* in North-West Tirhut, डधा *dhattha* also in North-East Tirhut, डॉठा *dhānthā* in South Bhagalpur, and लाठी *lāthi* also in South-East Tirhut. This brushing is hard work, and takes eight men to do it properly. The brushing is along the threads, and not across them. The bristles of the brush are made of खख *khaskhas*, called also in Sāran कत्रा के जड़ *katra ke jar*, such as is used for tatties, and are about two and a half inches long. The brush itself is about a foot long and two inches wide. The brushing went on for three days, and is called पार करण *pāi karab*, and also in East Tirhut तसन करण *tāsan karab*. The phrase पार पार *āi pāi* means the brushing and other preparations, and there is a proverb, जोखना के पार पार, चमरा के बिहान *jolha ke āi pāi, chamra ke bihān*,—when a weaver says the cloth will be soon ready, as he is now brushing it, don't believe him, any more than you believe a shoemaker who says 'the boots will be ready to-morrow.'

363. When this was concluded, the threads were put into the loom and woven at the rate of a yard a day. The loom is little different

from that used in England. It is called करिग *kariyah* to the west and करग *kargah* to the east. It consists of the following parts:—

- (1) The *shuttle*.—This is धरकी *dharki* in Gaya and to the west, and कपरबिनी *kaparbinni* or कपरबीनी *kaparbini* to the east. In North-East Tirhut it is also called कपरनी *kaparni*.
- (2) The *needle* inside the shuttle, on which the thread is wound, is तिरि *tiri*, and the tube which revolves on this चुकी *chhuchhi*, or in Shahabad चुकी *thhunchhi*. When thread is wound on this tube the whole is called नरी *nari*, also in East Tirhut लरी *lari*. This is held in its place in the hollow of the shuttle by a pin made of a feather. This is called पखनरी *pakhnari* to the west and in South-East Tirhut, बीर *bir* in South Bhagalpur, and पखबीर *pakhbir* or पखेवारी *pakhedari* to the east. A weaver estimates his work by the number of नरी *nari* which he uses up, as in the proverb in which he is supposed to address a man who has seized him to carry a load, उंगनच नऽ उंगच, नहिं नऽ नौ नरीक चरकति चोगत *tangbah ta tanyah, nahin ta nau narik harkati hoet*,—if you must load me, load me quickly, otherwise the time of nine shuttles will be wasted.
- (3) The *wooden frame* suspended from the roof, which after the shuttle passes is pulled forward by the weaver and drives the thread home. This is हाथा *hathā* or हाता *hattha* in West Shahabad, Patna, and West Tirhut, कामहँक *kamhanr* in the west generally, कामहार *kamhar* in the north-west, and कामहन्दा *kamhanda* in Gaya. In North-East Tirhut it is ताना *tāna*, and in South-East Tirhut तानी *tāni*. In South Bhagalpur it is तनकर *tankar*.
- (4) The *comb* of reeds or bamboo in this bar, which keeps the threads of the warp apart, is called राच *rāchh*.
- (5) The *heddles*, which alternately raise or depress the threads of the warp, are बाय *bae* or बै *bai*.
- (6) The set of three *reeds* which is placed in front of the heddles to keep the two sets of the threads of the warp apart is

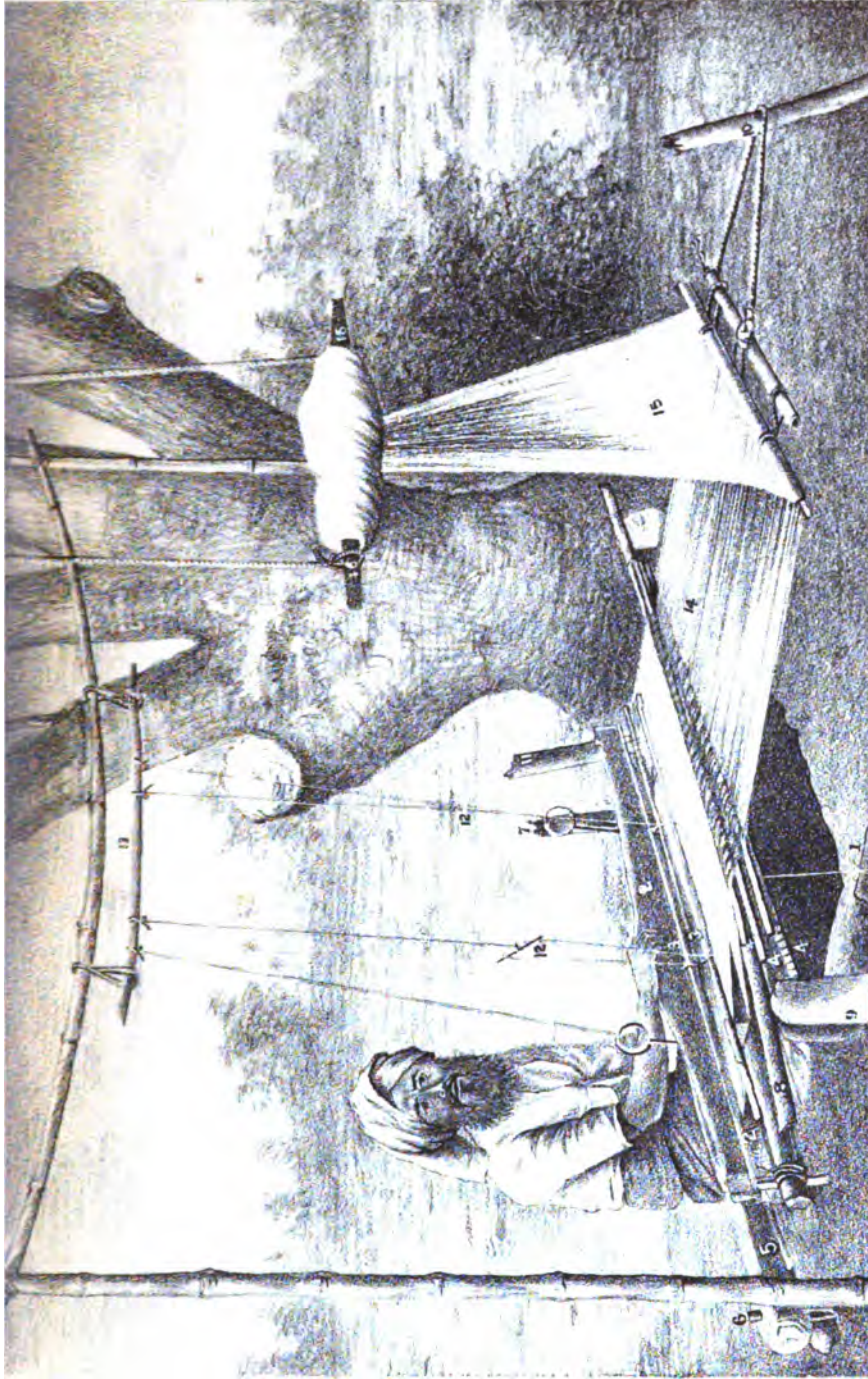

The Country Loom (Kariyah).

1. *Haika.*
2. *Rakk (comb).*
3. *Bei (head-les).*
- 4, 4. *Ser.*

5. *Chaspal (roller).*
6. *Jibhola.*
7. *Bamwari.*
8. *Kharthaut.*

9. *Kanaili.*
10. *Agela.*
11. *Dorbandha.*
- 12, 12. *Nachni (beddle-levers).*

13. *Kar (upper beam).*
14. *Pas (woof).*
15. *Sindra.*
16. *Tungni.*



अतःरावण *atrāwan* north of the Ganges generally and in Shahabad, and तरावन *tarāwan* elsewhere south of the Ganges. Another set of three reeds also used is called भंजनी *bhanjini* in Champāran, North Tirhut, Gaya, and South Munger, and the two sets together are called in North-East Tirhut अतःरावण बाँज *atrāwan bhānj*. In Patna and the south-east the reeds are also called सर *sar*.

- (7) The elastic *bow* which keeps the woven cloth stretched in front of the weaver is पन्निक *pannik* south of the Ganges; north of the Ganges it is पन्निक *pannikh*, and also पन्नी *panni* in East Tirhut.
- (8) The wooden *roller* behind which the weaver sits, and on which the cloth is wound up as fast as it is made, is in the north-west, in West Shahabad, and in South Munger लपेटन *lapetan*; elsewhere it is चौपन *chaupan*.
- (9) This is supported by *posts* called खूँटा *khūnta*; also the right and left ones have different names, viz. the right-hand one, which passes through the roller and prevents it turning round, is जिभेला *jibhela* everywhere, in North-East Tirhut also जिहला *jihla*, and in South-East Tirhut also जिहेला *jihela*. In South Bhagalpur it is गाली खूँटा *gāli khūnta*. The left-hand one, against which the roller rests, is बँधेला *banghela* north of the Ganges everywhere. Also, in East Tirhut, as also to the west and Gaya, it is बँवारी *bamwāri* or बँवरिया *bamwariya*, in Shahabad it is also पधेला *pachhela*, and in South-West Tirhut कंधेला *kandhela*. In South-East Tirhut it is also called बमैला *bamaila*. In South Bhagalpur it is simply खुँटा *khutta*.
- (10) The woof is supported at the end opposite the weaver by a piece of wood called खरकौंड *kharkaut* to the west and खरकौंडी *kharkauti* to the east or खरकुंडी *kharkūti* in South Bhagalpur, which is held up by pillars called कानैली *kanaili* to the north and west, खूँटा *khūnta* in East Tirhut, थूम *thūm* in Patna, थुम्बी *thumbhi* in Gaya, and थुम्बा *thumbha* in the east, and also खरकौ खूँटा *kharko khūnta* in South Bhagalpur.

- (11) The woof is held tight by a string, which is fastened to its end and passes round a peg at the extreme end of the loom and back again up to the weaver, where it is fastened within his reach to another peg. He is thus able to slacken the woof as necessary. The first peg is called **अगेला के खूंटा** *agela ke khūnta*, or in Tirhut **सरकौनी के खूंटी** *sarkauni ke khūnti*; the second peg is called **दोरबन्धा के खूंटा** *dorbandha ke khūnta*, or in South Bhagalpur **कनकिल्ली** *kankilli*.
- (12) The *treadle*, which the weaver moves with his foot, is **पौसर** *paunsār* or **पौसर** *pausār* generally, and in East Tirhut **पसर** *pasār*. The knob on this, held between the weaver's toes, is **पौतान** *pautān*.
- (13) The *upper levers*, to which the heddles are attached, are **नचनी** *nachni* generally. In East Tirhut they are **लोचनी** *lochni*, and in South Munger **लचनी** *lachni*.
- (14) These levers are fastened to an *upper beam*, which has various names, viz. **अधेर** *abher* to the west, **भितभेरा** *bhitbhera* in Sāran and Champāran, **धचाना** *dhachāna* in South-West Tirhut, **धचान** *dhachān* or **अकासी** *akāsi* in North-East Tirhut, **उपरकर** *uparkar* in South-East Tirhut, **करबार** *karbār* in Gaya, and **कर** *kar* in Patna and South Munger.

364. The loose end of the woof (**पार** *pāi*) is called **सिरारा** *sirāra*, and it is wound up on a **तंगनी** *tangni*, which is hung up out of the way.

CHAPTER VI.—THE SALTPETRE MANUFACTURER.

365. He is called **नोनियाँ** *noniyān*. The round vat in which he dissolves the saltpetre from the saline earth is **कोठी** *kothi* north of the Ganges, and south of it **अहरी** *ahri*. The mother liquid thus produced flows out through a drain called **पनार** *panār* in Tirhut and to the east, and **पौनार** *paunār* to the west; also in Sāran **मोहान** *mohān*, and in South-West Shahabad **परनौहा** *parnauha*. It flows into an earthen vessel fixed in the ground, called **नदहा** *nadha*, **नाद** *nād*, or **नादा** *nāda*, also **परच्छा** *parchha* in Tirhut and towards the west, and **गडनी** *garni* in South-East Tirhut.

366. The mother liquid is called **रस** *ras*, or in South-West Shahabad **अगरस** *agras*. After the saltpetre has been deposited, the

refuse liquid from which salt can be educed is called पचाड़ी *pachhari*, or in South-West Shahabad काही *kahi*. In Saran काही *kahi* means the liquor from which salt is educed, and पचाड़ी *pachhari* the refuse which is thrown away.

367. Over the round vat are placed bamboo rafters, which are called कोरई *korai* to the west, कोरो *koro* in North-East Tirhut, and पटवटन *patwatan* in South-East Tirhut. These are supported on bricks, ईटा *inta*, and over them is spread straw, called चाजा *chhaja*, चिह्नी *chhitti*, or खर *khar*.

368. The mother liquor is boiled in a large iron pan called कराह *karah*, or (to the east) तौला *taula*. When made of earth it is called कुदा *kunda*, or in Saran खोर *khor*. The fireplace is called चूल्हा *chulha*. The pot for cooling the boiled liquid is चँड़िया *hanriya*, or to the east तौला *taula*.

369. The iron curved spud by which the saline earth is scraped from the ground or wall is खुरपा *khurpa*, and the mattock for digging is फहरा *phahura* to the west, कोदार *kodar* in Tirhut, and कुदारी *kudari* in Saran. The basket for carrying the saline earth is टोकड़ी *tokri*, and that for carrying the saltpetre चँडी *chhainti*.

370. In South-West Shahabad—

- (a) जरुवा खोरा *jarua sora* is saltpetre prepared by boiling ;
- (b) आबी खोरा *abi sora* is saltpetre prepared by evaporation by the sun's rays ; and
- (c) कल्मी खोरा *kalmi sora* is refined saltpetre.

CHAPTER VII.—A DISTILLERY OF COUNTRY-LIQUOR.

371. भड्डीदार *bhatthidar* or चाबन्कार *abkar* is a distiller. In Saran he is also called रँकी *ranksi*. काला *kalal* is a Muhammadan who sells country-wine ; कालुवर *kaluvar* is a Hindu who does this. काला *kalal* and रँकी *ranksi* are caste names. When a man of another caste sells liquor, either on his own account or as a servant, he is called गद्दीवान *gaddiwan*. भड्डी *bhatthi* is a distillery. काला *kalali* or गद्दी *gaddi* is a place where country-spirits are sold.

372. The still is called भड्डी *bhatthi*, and consists of the following parts:—

- (1) देग *deg* or डेग *deg*, the boiler.—This has a baked earthen cover called चबन्कार *adhkār*, or in Saran चबन्कार *adhkār*.

- (2) Over this is inverted a wide-mouthed globular copper vessel; this is called ताम्बी *tāmmi*, or in Saran तमिया *tamiya*. It serves as a condensing-vessel. The spirit rises into it, and over its outside surface runs continually a supply of cold water.
- (3) The water reservoir is नाद *nād*. The water flows from this through a pipe called पौनली *paunalli*, or in South Bhagalpur पनाली *pannāli*, and in Saran also डोंगा *dhonga*, on to the top of the condensing-vessel.
- (4) The spirit thus condensed flows out through a pipe called मध्नरी *madhnari*.
- (5) The spirit is collected in an earthen jar called टांक *tānk* or मटुका *matuka*, and in this it is carried to the place of sale.
- (6) The refuse left in the boiler is रस *ras*; also, in Gaya, बकसा *baksa*, and in South Bhagalpur also गौरा *gora*.
- (7) साजन *sājan* or चाबन *chhāban* is water used for diluting spirit, so as to increase the quantity for sale.
- (8) The liquid for distillation is made as follows. Liquid (रस *ras*) and sweet preparations (मीठा *mītha*) are mixed and buried in the ground. This mixture is called कसौजी *kasauji*. When it is ripe महुआ *mahua* is poured into it. This act of mixing is called भरती *bharti*. When the mixture is sufficiently fermented for distillation it is called बोझार *bojhāi*. The constituents of the रस *ras* and of the मीठा *mītha* vary, and are not detailed here.
- (9) Earthen cups for drinking country-spirit are चुक्कर *chukkar*, गुरकी *gurki*, or पिठौचा *pitaua*.
- (10) Pots for keeping the spirit in the shop are called माट *māt*, कोरेना *korena*, or in Shahabad कौरना *kaurena* and बरबाम *buiyām*. In Saran another name is कराबा *karāba*.

373. Ordinary weak country-spirit is दोकानी *dokāni*, and also in Saran कशिबा *khasiya*; the next strongest (when made of गूर *gūr* only) is कन्दी *kandī* or (when made of other materials) दोबारा *dobāra*; the next strongest is सौंफी *saumphī*, or in South-East Tirhut सेबारा *sebāra*; and the strongest of all, महारदार *mahardār*.

SUBDIVISION VIII.

APPLIANCES USED BY MISCELLANEOUS VILLAGE TRADERS AND PROFESSIONALS.

CHAPTER I.—THE PALM-JUICE SELLER.

374. The palm-juice seller is पासी *pāsi*.

375. In climbing up the palm-tree he uses a heel-rope, which ties his feet close together. At the same time he has a stout rope passing round the tree and his body. He leans back against this rope, and presses the soles of his feet, thus tied together, against the tree. He then climbs up the tree by a series of hitches or jerks of his back and his feet alternately. The heel-rope is called मकरी *makri*, or to the west पकुची *pakusi*. In Shahabad it is पकसी *paksi*, and in Tirhut and Patna पँदिवा *phandiya*. The body-rope is generally दँदुवाँस *danwāns*. In the east it is also रसा *rassa*, and in South Munger बरंगना *bārta*.

376. The longish earthen pot in which the juice is collected is called लबनी *labni*, or to the east उरहर *urharh*. Round its neck is tied a string, called to the west अरवान *arwan* and to the east फनी *phanni* or फनकी *phanki*, or in South-East Tirhut रौना *rauna*. This string is hooked on to a hook, अँकुरा *ankura*, or in Sāran अँकुरा *ankurha*, in Shahabad अँकुसी *ankusi*, and in South Bhagalpur अँकोरा *ankora*, which is tied to the man's waist by a rope, लेवार *lewār*, or in Sāran दँरकस *danrkas*, in Champāran दँड़ा *dānra*, and in South Bhagalpur पेदर *petār*.

377. The sickle used for cutting the palm-tree is हँसुली *hansuli* to the west and हँसुवा *hansua* to the east. It is sharpened on a piece of wood called लौठा *lautha*, and also, to the east सोंडा *sonṭa*, or बलुथ *baluath* in South Bhagalpur and बलेठा *balettha* in South Munger.

378. A हथौना *hathauna* or तरकडी *tarkatti*, or in Sāran लबना *labna*, is a large longish earthen pot for holding toddy (ताड़ी *tāri*). In South Bhagalpur तौला *taula* or कुंडा *kunda* is an ordinary vessel for holding it. नापा *nāpa*, or in Sāran नपची *naphi*, is a small earthen pot used for measuring it, and जोरवा *zorwa*, बररिया *barariya*, and गोहवाँ *gohwān* are in South Bhagalpur earthen vessels in which toddy is sold.

379. A toddy palm-tree is तार or ताड़ *tār*, and the juice is तारी or ताड़ी *tāri*. There are two kinds of this tree—the female one, which bears fruit and is called फलतार *phaltār*, or in South Bhagalpur फला *phalla*, and the male one, which produces hairy flowers and is

called बलंगार *baltār* or फलंगार *phultār*, or in North-East Tirhut फलुदो *phuldo*, and in Saran बलिहा *baliha*. A खंगरा *khangra*, खग्रा *khagra*, or खगरी *khagri* is a young palm-tree. A कोही *korhi* (North-East Tirhut) or a बहिरा *bahira* (South-East Tirhut), बंजी सिस्वा *bānji siswa* or अनाथु *anāthu* (South-West Tirhut), is a palm-tree which does not produce juice; a बसन्ती *basanti* is a tree which produces juice in spring, and जेठुआ *jethua*, or in Saran साल *sāl*, one which does so in summer, while घौद *ghaud* is one which does so all the year round. In the east घौर *ghaur* is a tree which produces juice in the rainy season.

380. To cut a palm-tree for the juice is छेष *chhewab*.

CHAPTER II.—THE BIRD-CATCHER.

381. The bird-catcher or मिरसिकार *mirsikār*, or in Shahabad बहलिहा *baheliya*, uses a number of नल *nal* or नर *nar*, which are long shafts of bamboo tied together like a fishing rod, of which the top one is called कम्पा *kampa*, or in South Bhagalpur खोंचा *khoncha*. On this last is applied bird-lime (लासा *lāsa*), and the bird-catcher cautiously approaches the bird, concealing himself behind a टट्टी *tatti* or screen of leaves and branches. When the bird is within distance it is struck with the limed कम्पा *kampa*, and thus caught. The चोंगा *chonga* is the bamboo tube for keeping the bird-lime.

382. The फाँद *phānd* or फाँदा *phānda* and चौगोड़ा *chaugora* are two kinds of nooses. बटियारी *batiyari* is a net used in the day-time, and चानर *chātar*, one used at night for catching birds.

CHAPTER III.—THE BARBER.

383. The barber is हजाम *hajām*, ठाकुर *thākur*, नार *nāi*, नाउ *nāu*, or नौवा *naua*. In North East Tirhut he is also नहेरि *naheri*, and in Saran sometimes ओस्ता *osta*. He has his छोहर *lokhar* or किसमत *kismat*, किसमत *kisbat*, or किसबद *kisbad*, which is his instrument-bag. Also he has a चमौटा *chamauta* or चमौटी *chamauti*, or piece of thick leather used as a strop, a मोचना *mochna* or tweezers, and a हुरा *chhūra* or असूरा *astūra*, or to the east खुर *khūr*, or razor. His nail-parers are नहरनी *naharni*, but in Champārān they are नहरन *nahrān*, and लहरनी *laharni* in East

Tirhut. His whetstone is *सिला silla* or *सिली silli*. *कैंची kainchi* is his scissors, *कटोरी katori* his brass cup for water, *दरपन darpan* his looking-glass, and *लुङ्गी lungi* the cloth which he spreads in front of the person he is shaving, and on which the hairs fall.

CHAPTER IV.—THE COUNTRY SURGEON.

384. The country surgeon is *जरग्राह jarrah*, *जराह jarah*, or *हजाम hajām*.

385. Among his instruments are *जमूरा jamāra*, a tooth-extractor, *चोभा chobha* or *नखार nastar*, a lancet for the arm, and *ठुन्का thunka*, a lancet for the head.

386. For circumcision (*सुन्नत sunnat* or *खतना khatna*) he has *जन्नी jantri*, *घोड़ी ghori*, or in South Bhagalpur *चूँटा chūnta*, which are nippers of bamboo, and *सलई salāi*, which is a bamboo needle for holding up the foreskin.

CHAPTER V.—THE FARRIER.

387. The farrier or *नालबन्द nālband* has the following appliances.

388. A *मेखारी mekhāri* or *किसबत kisbat*, which is the bag in which his tools are carried, a *छुरी chhūri* or curved knife, a *सुमनरास sumtarās* or large curved knife, a *जम्बूर jāmbūr* or pincers, a *रेत ret* or file, a *बलखा balkha* or *मार्तौल mārtaul* or small but long hammer, a *दोहाडी doāli*, or in South Bhagalpur *बलखा balkha*, which is a leather for holding up the horse's hoof, a *पुजमाल pujmāl* or hair string for tying the ear of a refractory horse, a *हलखा halkha* or iron ring, and a *सुमकड़ी sumkatti* or chisel for cutting the horse's hoof.

CHAPTER VI.—THE WASHERMAN.

389. The *धोबी dhobi* or washerman uses a *पटाथा patha* or *pāt*, which is the washing-board, of which the support is in Shahabad *ठेहवा thehua* or *नेवन्थ newnath*. In South-West Tirhut it is

called चौकी *chayki*, and, when made of stone, पथल *pathal*. His iron is रसगिरी *istiri* or (in North-East Tirhut) मिस्गिरी *mistiri*. His ironing cloth is बेटन *bethan*, and his staroh कलप *kalap* or कलप *kalaph*.

390. When the article to be washed is too heavy for him to lift up and dash upon the washing-board, he beats it with a mallet, called मुंगरा *mungra* or मुंगरी *mungri*, or (in Saran) दंसन *dānsan*, (in North-East Tirhut) सोंटा *sonta*, and in South-East Tirhut लाठी *lāthi*. In South-West Shahabad it is called कठका *kathka*, and in South Bhagalpur दोबदांग *dhobdāng*. The clothes-line or drying-frame is तनाव *tandav*. His bundle of clothes is बकुचा *bakucha*.

391. The act of beating the clothes is कुन्दी *kundi*, and to beat the clothes is पीटन *pītab*, or धोएन *dhoël* north of the Ganges, बिहारब *bichharab* (in Patna), निहारब *nichharab* (in Gaya), निहारल *nikhāral* (in Shahabad), खींचन *khinchab* (in South Bhagalpur), and चहंतन *chhāntab* or खींचन *phinchab* (in South Munger and Shahabad).

392. South of the Ganges clothes which are well washed are निमाड़ *nimār*, or in South Bhagalpur गोबरजार *gobar jhār*. In Champāran they are निहार *nikhār*. The half-washing given to new clothes is खमसो *khamso*, or in South Bhagalpur खामसो *khāmsō*. In Gaya the washing of a cloth after it has had patterns printed on it is बिहारनी *bichharni*.

393. The honesty of the washerman and his tenderness for the clothes committed to his care are not considered of much account in Bihār, and there are numerous proverbs coined at his expense, e.g. धोबी पर धोबी बसे, तब कपड़ा पर साबुन पड़े *dhobi par dhobi base, tab kapra par sabun pare*,—no soap ever touches clothes unless many washermen live together (when owing to competition they wash well). Again, धोबिक बाप केर किछु नहिं फाट *dhobik bāp ker kichhu nahin phāt*,—nothing belonging to a washerman's father is ever torn by him (*i.e.* those are the only clothes about which he is careful). It is also a wise precaution, which according to Bihār ideas should universally be adopted, to disbelieve a washerman when he says the clothes are 'nearly' ready. A washerman's donkey is a bye-word, as in the proverb गध्या के न दोसर गोसैयाँ, धोबिया के न दोसर परोहन, *gadha ken na dosar gosainyān, dhobiya ken na dosar parohan*,—an ass has only one master (a washerman), and the washerman has only one steed (a donkey). Again धोबी नाच दरजी, ई तीनू बसःगरजी *dhobi, nāū, darji, i timu algarji*,—there are three careless people, the washerman, the barber, and the tailor.

SUBDIVISION IX.

TOOLS AND APPLIANCES USED BY COUNTRY ARTI-
ZANS.

CHAPTER I.—THE CARPENTER AND TURNER.

394. The carpenter is बड़ही *barhi*, or in East Bihār optionally कमार *kamār*. In South Bhagalpur he is also called मरुईया *maraiya*. His workshop is कमरुसायर *kamarsāyar* or बड़ही खाणा *barhi khāna*. A proverb about him is ई बरिबक गाम कमेसाह जमिका बजान मठ बड़हा *i buribak gām kamaitāh, janika rukhān na basula*,—this fool (of a carpenter) would serve the village when he has neither chisel nor adze; said of one who undertakes to do a thing without possessing the means. He uses the following tools:—

395. The adze.—बड़हा *basūla* or, especially in South and West Bihār and South Bhagalpur, बड़हा *basula*. In South Munger it is बसिला *basila*. A similar tool is टङ्गा *tanga*, तँगा *tānga*, तँगी *tāngi*, or तँगारी *tāngāri*. In North and East Bihār it is also called कुहारी *kulhāri*. This is a larger adze, and is used chiefly by sawyers (अरकसिया *arkasiya* or आराकस *ārākas*) in squaring logs, and by carpenters for rough work or for cutting down trees.

396. The large saw.—आरा *āra*, and south of the Ganges also अररा *arra*. The small saw.—आरी *āri*.

397. The large hammer.—हथौरा *hāthaura*, or in South Bhagalpur लिहावर *lihāvar*. The small hammer.—हथौरी *hathauri*, मारन्तोड़ *mārtaul*, and in West Tirhut and south of the Ganges also बज *ghan*. In South Bhagalpur it is called मरिवा *mariva*.

398. The बरन्ना *barma* or बरन्ना *barman* is a revolving awl or drill, worked with a bow and string, and used as a gimlet or centre-bit. The bow used with it is कामनी *kamāni*, or in South-West Shahabad कामनाक *kamānak*. The handle round which the string goes is गुलफी *gulphi* or गुली *gulli*. In South and East Tirhut the word is कुलफी *kulphi*. In Gaya it is मूठ *mūth*. The cap at the top, on which the palm of the hand rests to press the awl, is टोपी *topi*, पैला *paila*, दबनी *dabni*, or दबौटा *dabauta*. The awl itself is बरन्ना *barma* or बरन्ना *barman*. The string is north of the Ganges दोवाली *doāli*, and south of it डोरी *dori* or जोती *joti*, or in South-West Shahabad जेवर *jemvar*.

399. The following are various kinds of *chisels*:—

- (a) The कचक *kachchak* north of the Ganges, and the बटारी *batāri* or बटाही *batāli* south of the Ganges, is broad at the base and narrow at the point. In South Bhagalpur it is called कज्जक *kajjak*.
- (b) The रम्बा *ramba* is a long chisel for making mortice holes.
- (c) The चौरसा *choursa* is broad and straight; another name in Gaya and Shahabad is बटाही *batāsi*.
- (d) The रुखान *rukhān* or रुखानी *rukhāni* is like the *kachchak*, but is larger and thicker, and is used for coarse work. It is also a generic term for all chisels.
- (e) A small chisel with a rounded edge for making lines on wood is north of the Ganges गोखक बुरज चाप *golak buruj khāb*. South of the Ganges and in Saran it is गिरदा *girda* or गोरदर रम्बा *gordār randa*. In South Bhagalpur it is also खोलिया *kholiya*.

400. *Gouges* are गोखक *golak*, गोखक *golakh* (Gaya), गोला रुखानी *gola rukhāni*, or गोरदर रुखानी *gordār rukhāni*; other names are गौच *gauch* (South-West Tirhut) and गिरमित *gimit* (? gimlet), North-West Tirhut. A large gouge for heavy work, such as hollowing out rice-mortars, is बँक रुखानी *bānk rukhāni*. A square gouge is कचक रुखानी *kachchak rukhāni*.

401. The common *plane* is रम्बा *randa*, of which the blade is पत्ती *phalli*, or in Shahabad पलसा *phalsa*, and the body कुन्दा *kunda*. The wedge for holding the blade has various names, viz. north of the Ganges खँटी *khānti*, ठेकी *theki*, or चेखी *chaili*. South of the Ganges it is in Shahabad खँटी *khunti* or ठेपी *thepi*, and to the east पच्छी *pachchi*, पचरी *puchri*, or पचड़ *pachchar*. When the blade has a coarse edge for rough work, it is जहना रम्बा *jharna randa*; also दान्त रम्बा *dānt randa* in South-West Shahabad. A plane with a fine blade is साफी रम्बा *sāphi randa*. The दर्राज *darāj* is a narrow plane for squaring the edges of boards.

402. *Grooving-planes*.—There are—

- (a) The plane for cutting square grooves.—बुरज चाप *buruj khāb*, or (South of the Ganges) बुरज (or गुरज) चाप *buruj* (or *guruj*) *khāp*.
- (b) The गल्ला *galta* is for cutting round grooves. In West Bihār and South Munger it is also called खिरची *khirchi* or खिल्ली *khilli*.





TURNER (KHARADDI) AT WORK.

Ench. by Hem Chunder Ghosal, Student, Govt. School of Art Calcutta.

Printed by Abdool Rehm Govt. School of Art, Calcutta.

- (c) The *झारी के रन्दा* *jhāri ke randa* or (north of the Ganges) *पल्लु* *palḷun* is a plane for making grooves for panelling.

403. The following are files :—

- (a) *रेती* *reti* is the common file.
- (b) The file for sharpening saws is generally *कतारा* *katra*. Local names are *कतारि* *katari* in North-West Tirhut, *कतारोही* *katrohi* in East Tirhut, *तेपल* *tephal* in Gaya and Shahabad, *तेपला* *tephalla* in Saran, and *कान्डी* *kandī* in West Shahabad.
- (c) *सोहन* *sohan*, or in East Tirhut *सोहेन* *sohen*, is a coarse rasp.
- (d) The *चौरन्वा* *chorsa*, or to the west *चौरन्वा* *chaurasa*, is a broad file.
- (e) The *निमगीरिद* *nimgīrid* is a half-round polishing file. In South Bhagalpur it is *मेगिरी* *maigiri*.
- (f) The *चौरस रेति* *chauras reti*, or in South Bhagalpur *चौपल* *chaupahal* *रेती* *chaupahal reti*, is a square file.

404. The *square*, or gnomon, is *बटाम* *batām*, *गुमिर्वा* *guniyān*, or *चलना बटाम* *challa batām*. The *compasses* are *परन्काळ* *parkāl*. A *blunt point* for drawing lines is *खतकच* *khatkas*, or in South Bhagalpur *कोरन्सुत* *korsūt*. *Sand-paper* is *सरेस काना* *sares kannā*, *सरेस कागज* *sares kāgaj*, or *सरेस पत्ता* *sares pattā*. In South Bhagalpur it is *साफी* *sāphi*. The *pincers* for drawing nails are *जम्हूरा* *jamhūra*, *जमूरा* *jamūra*, or *संख्खी* *sanṅhī*. *Glue* is *सरेस* *sares*. *पथल* *patthal*, *पवल* *pathal*, or *सिल* *sil*, is the *grindstone*. The *block* on which the man works is *ठीहा* *thīha*, *तेहा* *theha*, or in South Bhagalpur *ठिया* *thīya*, *ठिहा* *thiha*, or *परन्कडो* *parkattho*. In Gaya and Champaran it is called *परिघाटा* *pariyātha*.

405. The English *auger* is also used, and is called *खवंगर* *avgar*, or in Tirhut *गिरन्मिट* *girmit* (*P* = gimlet).

406. A *lathe* is *खाराद* *kharād*, and the man who works it is *खारादी* *kharādi*, a turner.

CHAPTER II.—THE BLACKSMITH.

407. The blacksmith is *खोहार* *lohār* generally, and in South-East Tirhut he is also *ठाकुर* *thākur* or *कमार* *kamār*. His smithy is *कमरन्सावर* *kamarsāvar*. In Saran it is also *कोखन्सारी* *lohsāri*, and in South Bhagalpur it is *कमरन्सारी* *kamarsāri* or *मदर* *marā*.

408. His *anvil* is *निहार nihāi* or *नेहार nehāi*; but in South-East Tirhut it is *लेहार lehāi*, and in South Bhagalpur *लिहार lihāi*. This is fixed in a block called *ठेहा theha* north of the Ganges, *ठीहा thiha* in Shahabad, and in South Bhagalpur *ठिया thiya*, *परकठ parkath*, or *गड़ियाच gariyās*. In Patna and South Munger it is *परेठा paretha* or *परहठा parhattha*, and in Gaya *परियाठा pariyaṭha*. In South-West Shahabad it is *आँकूठ ankuth*. A well-known proverb about an anvil is *सुन्न चोट नेहारक माँचा sunn chot nehāik māncha*,—it the anvil has nothing on it, the blow falls on its head.

409. The *ghanmudhi* is the *swage block* or *perforated anvil* on which iron is placed when being pierced with holes, and *बीरो biri* or *बीर bi* (east generally, Patna, and Gaya) or *हाना hanna* (South Bhagalpur) is the round block of iron placed on this, also pierced with a hole. This latter is also used for making heads of nails, and another name for it is *चप्रवान chapraṅwan*, *चप्रवौना chaprauna*, or *चप्रवौनी chaprauni*.

410. The large *hammer* for welding is *घन ghan*; smaller than this is the *हथौर hathaur* or *हथौरा hathaura*; and smaller still the *हथौरी hathauri* or *मरिया mariya*.

411. The *जम्हूरा jamhūra* or *जमूरा jamūra* is a pair of *pincers* or *tongs* round at the tips; other names are *गडुआ gahua* (Champaran, West Tirhut, and Patna), *सँदुखी sanrei* (Shahabad and South Bhagalpur), and *बँदुरी banguri* (South-West Shahabad). Everywhere *सँदुखी sanrei* is used for a pincer adapted for taking a hot piece of iron out of the fire, tightening nuts, &c. To the west the *सुगही sugahi* is a pair of horn or wooden pincers.

412. The iron *poker* for stirring the fire is north of the Ganges *अँकुरा ankurha*; in Gaya and Shahabad it is *अँकुरा ankura* or *अँकुरी ankuri*; and in South Bhagalpur *अँकोरा ankora* or *आँकुरा onkra*. North of the Ganges, to the west, it is also *कुल्लारा kullāra*; while in Patna, Gaya, and South Munger it is *कोल्लारा kollāra*.

413. The *cold chisel* is *छेनी chheni*, and the chisel for making holes in iron is *टोपन topan*, with a variant *टोपना topna* in Patna and Gaya; another name is *सुम्हा sumbha* south of the Ganges or *सुम्मा summa* or *सुम्मी summi* north of the Ganges.

414. The fixed *bellows* is *भाथी bhāthi*, and also (south of the Ganges) *माँची bhānṭhi*. The hand-bellows is *दुहन्थी duhanṭhi* when worked with both hands, *एकहन्थी ekhanṭhi* when worked with one hand, and *दुपौचा*

supau in South-West Shahabad. In the south-east it is also कठ बाँची *kath bhānchi*. The end of the bellows pipe which goes into the fire is बड़ा *mūra*, बड़ी *mūri*, or मुदिवा *muriya*. In Saran it is अँकुरा *ankurha*; in South Bhagalpur, बड़ी *mūri* or साखक *sālak*; in Patna, मोकखा *mokkha*; and in South Munger, मोकरी *mokhri*. The pipe itself is फूंक *phūnk*; also north of the Ganges and to the west चूँची *chhūnchhi* or चुचो *chhuch-chhi*; and in Patna, Gaya, Saran, and East Tirhut चोंगा *chonga*, or in South Tirhut चोंगी *chongi*. The clay pipe over this is वारन *āran* or वरन्नी *arni*, or in South-East Tirhut वार *ar*. In East Tirhut it is also मतिवम *matiham*, and in South-East Tirhut मेहुम *metum*. The wooden sides of the bellows are तखता *takhta*; also in Patna, Gaya, and South-West Shahabad पट्टा *patra*. The leather sides are चमड़ा *chamra*; also चाम *chām* (optionally south of the Ganges) and खाल *khāl* in Champaran, Patna, and Gaya. The valve is पक्का *pankha* or पकी *pankhi*; also (in Patna) पकड़ी *pankhri*. In South-East Tirhut and Champaran it is गड़ी *gaddi*. The pivot on which the pair of bellows works is कौड़ा *kourha* north of the Ganges; also in North-West Tirhut सुरसा *sursa*. South of the Ganges, to the west, it is धूरी *dhūri*, and अँकुरा *ankura* to the east and also in Shahabad and Champaran. The pillars which support it are खम्बा *khambha* north of the Ganges and खूँटा *khūnta* south of the Ganges and in South-East Tirhut. The upper iron bar is बरेड़ा *barenra* or बरेड़ी *barenri* north of the Ganges, and बरेठा *baretha* in Patna and Gaya. In Shahabad it is बेदिवा *benriya*, in South Bhagalpur दन्दा *danda*, and in South-East Tirhut दन्ता *danta*. The lever which works the bellows is चौप *chhip* in the North Gangetic tract, and also दन्ता *danta* in Tirhut; south of the Ganges it is लाठ *lath* or लाठा *lātha*, and in South-West Shahabad दन्दा *danda*. In South-West Shahabad a small bellows worked by both hands is मेरुवा बाँची *menraruā bhānchi*. A well-known saying about the bellows is तुलसी जाच गरीब के हरि सेँ सरस न जाच, तुचला चाम काँ फूँक सेँ जोच भवन जो जाच *tulasi āh garīb ke hari señ sahal na jāy, muala chām kā phūnk señ jō bhāsam ho jāy*,—O Tulsi! God cannot withstand the sigh of a poor man: the blowing of dead leather (in a bellows) reduces iron to ashes.

415. The बरना *barma* is a *revolving awl* or *drill* worked with a bow, कामानी *kamāni*, with a leather string, तखता *tasma*. Sometimes a string is used instead of a bow, and this is called दोचाडी *doāhi* or जोटी *joti*, or in South-West Shahabad जँवर *jemwar*. The iron spike of the awl is north of the Ganges दन्दी *dandi* to the west and धली *phalli* to the east. South of the Ganges we have दँस *dāns* in Shahabad, दन्ती *danti* in Patna and Gaya, and दन्दी *dandi* again in the south-east.

416. The fixed *vice* is बाँक *bānk* or (in South Bhagalpur and South Munger) बैस *bais* ($P=$ vice), and the hand-vice is हथकल *hath-kal* or (in Patna and Gaya) हाँथकल *hānthkal*. The two sides of the vice which grasp the iron are पाला *palla*; the screw is मुसुरा *musra*, or in North-West Tirhut कबला *kabla*; and the socket for the screw to work in is कुचो *chhuchohhi*, except in Shahabad, where it is चोंगिया *chongiya*, and South Bhagalpur and Champāran, where it is चोंगा *chonga*. The handle for turning the screw is north of the Ganges मुसुरा *musra* or चलाणी *chalauni*. The latter name is also current in Shahabad, where in the south-west of the district we also have हथकरा *hathkara* or दंदा *danda*. In South Bhagalpur it is हातुल *hātul* or हाथा *hattha*, and elsewhere it is हथरा *hathra*. The spring is कामानी *kamāni*.

417. The *tap and die* for making screws is north of the Ganges बाँदिया *bādiya* or बहीया *bādiya*; the latter is the usual form in North-East Tirhut. South of the Ganges, in Gaya and Shahabad, it is बदिवा *badiya*, and elsewhere बधिवा *badhiya*. In South Bhagalpur it is also called दार *dāi* (*die*). Of this the female screw is कुटका *kutka*, the tightening screw चुटकी *chutki*, and the nut-maker पेचका *pechka*. दिबरी *dhibri*, or in Sāran कबला *kabla*, is the nut of a screw.

418. The common *files* are रेती *reti*, and the round files गोळक *golak* or गोळक *golakh*, and in South Bhagalpur गोळ रेती *gol reti*. The half-round file is निमगीरिद *nimgirid*, and the triangular file in Sāran तिनपहा *tinphalla*, in Champāran तिरपहा *tirphāl*, in Shahabad तिरपहा *tirpahal*, in Tirhut तेषहा *tephal*, in Gaya तेषहा *tepahal*, and elsewhere तिनपहा *tinpahal* or तिरपहा *tirpahla*.

419. The *compasses* are परकाळ *parkāl* or कम्पास *kampās*. The *mould* is साँचा *sāncha*, and the vessel for cooling hot iron पनिहारा *panihāra* in Champāran, West Tirhut, and Gaya; पनिहंदा *panihanda* or पनहंदा *panhānda* in Shahabad and South-East Tirhut; चाहा *chāha* (also in South Munger), लबरी *laberi*, लाबर *lābar*, or लबेर *laber* also in South-East Tirhut; नबेर *naber* or नमेर *namer* in North-East Tirhut; and नबरी *naberi* in Tirhut generally. In South Bhagalpur it is पनचाहा *panchāha*.

CHAPTER III.—THE MASON OR BRICKLAYER.

420. The mason is called राज *rāj*, also राज मिस्त्रि *rāj mistiri* north of the Ganges, and राज मजूर *rāj majūr* in South Bhagalpur and South Munger. In Sāran and Champāran he is also थावई *thavai*.

421. He uses the बसुली *basuli*, which is a pointed *hammer* for cutting bricks. In Shahabad लोह *loh* is an iron hammer for breaking stones

422. His *trowels* are (1) करनी *karni*, the largest, for mixing mortar; (2) मंजोला *manjola* or (in South-West Shahabad) चपन्ना *adhla*, a smaller one; and नखला *nahla*, or in Tirhut and the west कलम *kalam* or कलमी *kalmi*, the smallest one, for polishing the surface of the mortar.

423. *Mortar* is मसाला *masāla* or (in North-East Tirhut) गच *gach* when made of brickdust and lime; when made of mud it is गिलावा *gilāwa*, also गर्गी *garrī*. (Patna, Champāran, and North-East Tirhut), गारा *gāra* (Sāran and the east), कादो *kādo* (South-West Tirhut), and डेर *lei* (South-West Shahabad).

424. The wooden *beater* for consolidating and smoothing plaster is मुंगरी *mungri* or चापी *thāpi*. The रोल *rol* or रौल *raul* (South Munger, Patna, Sāran, and Tirhut) is a long stick for smoothing the plaster. Other names are पखटा *pahta* or पाटा *pāta*, पैटा *paita*, पैखटा *paihta* (South Munger), and फरमा *pharma* in Gaya. In Shahabad and South Bhagalpur चिरना *chirna* is a slip of wood used for the same purpose. The *scoop* for making moulding is north of the Ganges and to the east generally गोलाकच *golākas*, and also to the east गोला *gola*. Elsewhere south of the Ganges and in Champāran it is खुरचुनी *khurchuni*.

425. The *plumb* is साइल *sāhul*. The string is सूत *sūt*, and in Champāran and South-East Tirhut also डोरी *dori*; and the small pieces of wood fixed on the string are केंड़ा *kenra* or कैड़ा *kainra* in Tirhut, Shahabad, Patna, and Gaya, पत्ती *pattī* in Sāran and Champāran, फिटकिरी *phitkiri* also in Champāran, East Tirhut, and South Munger, फिरकी *phirki* in South-West Shahabad, and फेटकिना *phetkina* in South Bhagalpur.

426. The *square* is गोनिचा *goniya*, गुनिचा *guniya*, or गुनिचौ *guniyān* to the west, also साधनी *sādhni* in Patna, Gaya, and north of the Ganges generally, and रबिल *rabbil* in South-East Tirhut and North Bhagalpur. To the west and in Gaya it is also बटाम *batām*.

427. The *maul-stick* is मिस्तर *mistar* in Patna, the North-West, and South Tirhut. In Tirhut, Gaya, and the west it is निस्तर *nistar*. In South Bhagalpur it is चीप *chīp*.

428. The whitewashing *brush* is कूची *kūchi*; in South Muager it is also जरनी *jharni*.

429. The *ladder* is सीढ़ी *sīrhi*, and the *scaffolding* मॉच *mānch* or मचान *machān* to the north of the Ganges. South of the Ganges the latter is पाढ़ *pārḥ* generally, or पाठ *pāth* in Shahabad. In Champāran, Patna, and Gaya it is also चाही *chāhī*.

430. The नगर or नगाड़ *tagār* (also नगाड़ी *tagāri* in Tirhut) is the pot in which the mortar is mixed. The mortar-pot is नार *nād* or नार *nānd*. The mortar-trough when made of clay is हारि *hāri*, also कोरा *koha* in East Tirhut, and optionally अथरा *athra* south of the Ganges. In South Bhagalpur it is also कार *karhāi*. When made of wood it is कठरा *kathra* or कठौती *kathauti*.

431. The bricks are ground into powder (सुरकी *surkhi*) by a crusher, हेंकी *dhenki* or (in Champāran) लाठ *lāth*. Of this the pestle is मूसर *mūsar* or मूसरा *musra*, or (in South-East Tirhut) समथ *samāth*. The piece of wood on which the bricks are sometimes crushed is ओखरी *okhri* north of the Ganges; south of the Ganges it is ओखला *okhla* in Gaya, उखली *ukhli* in South Munger, धुरिया *bhuriyān* in Patna, and कुरिया *kanriya* elsewhere. It is supported by pillars, which are कुंटा *khūnta* or कुंटा *khutta* in East Tirhut and south of the Ganges. In the latter tract they are also called खम्भा *khambha*. In West Tirhut and Sāran and Champāran they are जङ्गा *jangha* or खम्भा *khāma*. The axle on which it works is called खौता *akhauta* in Patna and Sāran, उखौता *ukhauta* in Gaya, and also खैला *akhaila* in Patna. In Champāran and North-West Tirhut it is मंजा *mānjha*, in South-West Tirhut किला *killa*, and in East Tirhut दंटा *danta*. Sometimes a hammer is used for breaking the bricks, which is called मुंगरा *mungra* or (in Shahabad) हाथकुटा *hathkutta*, and in Sāran थपी *thāpi*.

432. The large earthen pot for water is घैला *ghaila*, also ठिलिया *thiliya* in Gaya and गगरी *gagri* north of the Ganges. The smaller pot is हारि *hāri* or हारिया *hanriya*, also कोरा *khoha* in East Tirhut. South of the Ganges the pot with a spout for pouring water on the plaster is बधना *badhna*. In South Tirhut it is बधन *badhan*, and in South Bhagalpur जहरी *jhāri*. North of the Ganges generally कारवा *karwa* or कंटिया *kantiya* is used, and in East Tirhut also फुचकी *phuchki*.

CHAPTER IV.—THE GRAIN-PARCHER.

433. The grain-parcher is कानू *kānu* or कानू *kāndu*, with a variant कानू *kāndūn* in Champāran, Patna, and Gaya. In Champāran (optionally) and in South-West Shahabad he is called गोंड *gonr*, and north of the Ganges and to the south-east he is also known as बरभुंजा *bharbhūnja*. Parched grain is भुंजा *bhūnja*, or in Shahabad मुंजना *bhūnja*. When it bursts in the parching it is called लावा *lāwa* or फुठना *phutha*.



BRICK-CRUSHING MACHINE (*DIENKIJ*).





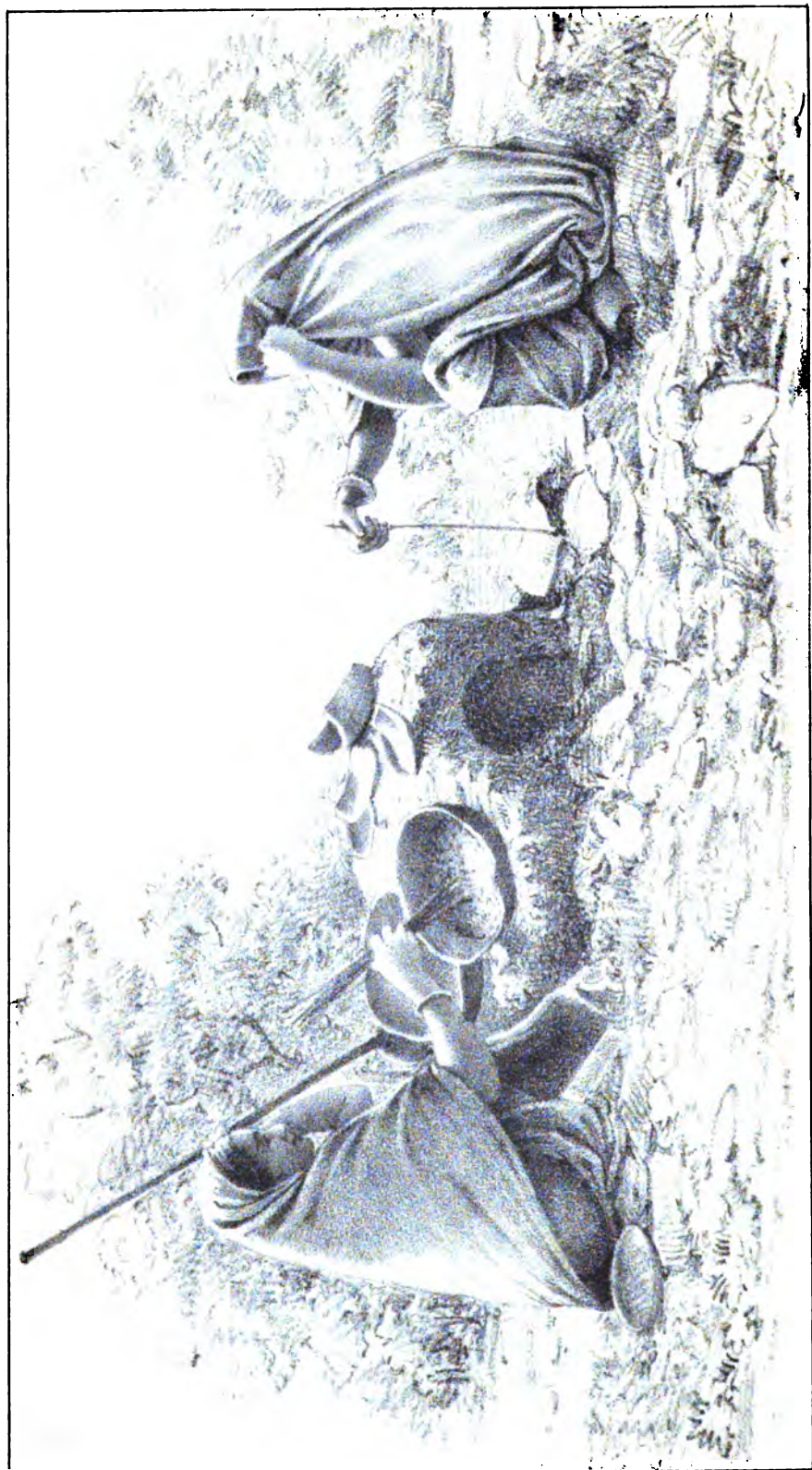

GRAIN-PARCHERS (KĀNDU) AT WORK.

434. His parching-house is **घोमवार** *ghonsār* or **घोमवारी** *ghonsār* to the west, and also to the west of the North Gangetic tract, **भमवारी** *bhansāri*. In South-West Shahabad it is **भरन्दाँच** *bharsāin*. The name **कन्वार** *kansār* or **कनिवार** *kanisār* is current in East Tirhut and to the east of the South Gangetic tract, including Patna and Gaya. In Tirhut it is also **कन्वारी** *kansāri*.

435. The fireplace is **चूल्हा** *chūlha* in Tirhut and to the east of the South Gangetic tract, including Patna and Gaya; also **भार** *bhār* generally, and **भमवार** *bhansār* north of the Ganges and in Gaya, and **घोमवार** *ghonsār* in Saran. In South-West Shahabad it is **भरन्दाँच** *bharsāin*.

436. The place in front of the stove, on which the grain falls, is **परु** *parū* in Shahabad and **परवा** *parvā* in South Munger. In Patna and South-East Tirhut it is **पौर** *paur*; in Gaya, South Bhagalpur, and North-West Tirhut **पौरी** *pauri*; and in Sāran and Champāran **पारी** *pāri*. Another name more or less current north of the Ganges is **चौतरा** *chautra*.

437. The earthen pot in which the grain is parched is **खपड़** *khāpar* or **खपड़ा** *khapra* when it is large with a wide mouth, and **खपड़ी** *khapri* when it is smaller. The latter is also called north of the Ganges **कुन्दा** *kunda* or **कुंदा** *kūnda*, to the west, and **तौला** *taula* to the east.

438. The iron spoon for taking out the hot sand is **कलहलु** *kalchhul* in Sāran and Champāran and South Munger, and **कलहलुहा** *kalchhula* in Patna and Gaya. In Shahabad it is **कलुह** *kaluchh* or (in the south-west) **कलुस** *kalus*. In South-East Tirhut it is **सरहिवा** *sarahiya*. In South-East Bihār it is called **दब्बु** *dabbu*. When made of earth with a bamboo handle it is called **धकनी** *dhakni* north of the Ganges and in South Munger, or **सरवा** *sarva* in North-East Tirhut.

439. The flat wood stirrer is called **दबिला** *dabila* to the west. In North Tirhut it is **दबिया** *dabiya*, and in South-East Tirhut **दाब** *dāb*, and in Gaya **कुरूर** *kurūr*. A kind of broom made of four or five reeds tied together is **झारु** *jhāru* (Patna and Gaya), **भुंजनाठी** *bhunjnāthi* or **बोदनी** *borhni* to the south-east, **बरनी** *barhni* to the east generally, **लरना** *larna* or **लारुनि** *lārani* in North-East Tirhut, **चिपनी** *chhipni* in South-East Tirhut, and **चलौनी** *chalauni* north of the Ganges.

440. The sieve is **चलनी** *chalni* generally, but **चलना** *chalna* in South-West Shahabad and **चालनि** *chālani* in East Tirhut. To the west it is also **जरना** *jharna*, and also in South-East Tirhut **सूप** *sūp*.

441. The *poker* is खोरना *khorna* or खोरनी *khorni* north of the Ganges and in South Bhagalpur and South Munger; elsewhere south of the Ganges it is खोड़ना *khorna* or खोड़नी *khorni*. In South-East Tirhut and Champāran it is खोरनाठी *khornāthi*.

442. The *basket* for the grain is north of the Ganges दौरा *daura* or दौरै *dauri*. South of the Ganges we have बटरी *batri* in Patna, मौनी *mauni* or मौनिया *mauniya* in Gaya and South Munger, भौकी *bhaunki* in Shahabad, and दलिया *daliya* in Champāran and South Bhagalpur. In Champāran and Gaya the सतगरवा *satgharwa*, and in South Munger the चाँद *chānr*, is an earthen vessel with seven or more divisions for various kinds of grain, and in South-East Tirhut a बेठकी *baithki* is a similar one with four divisions, and चन्ना *chhanna* one with six. कोचा *koha* or कँडिया *kantiya* in North-East and South-West Tirhut, and करवा *karwa* in Champāran, are earthen pots for grain, and कठरा *kathra* in Patna and Gaya, or कठौती *kathauti* elsewhere south of the Ganges, is a wooden pan.

443. The *grindstone* is जाँता *jānta* or (in South-West Shahabad) जाँत *jānt*. Its axle is किला *killa* or (in South-East Tirhut) कील *kil*, and it is made to revolve by a handle, which is हथरा or हथड़ा *hathra* generally, and जूचा *jūa* to the west, also चाकर in South-East Tirhut.

444. The *wages* in grain paid to the grain-paroher is भार *bhār*, or in South Bhagalpur भारे *bhāro*, as in the proverb जौ जरि नेछ, भार खा जावछ जौ *jau jari gel, bhār la bānhal chhi*,—the grain-paroher has burnt my barley and has tied me up for his fee (adding insult to injury). The quantity of grain parched at one time is घानी *ghāni*.

CHAPTER V.—THE BAKER.

445. The baker is generally नानबार *nānbāi*, with a local variant नानबार् *nānbāi* in Shahabad. In Gaya he is नानपज *nānpaj*. He is also called रोटीवाला *rotiwāla*. He is proverbially a rude fellow, and नानबार के खिन्ना *nānbāi ke khinga* is popularly used to mean a stout rude fellow.

446. He uses an *oven*, तनूर *tanūr* or तँदूर *tandūr*.

447. His *roasting-spit* is south of the Ganges सौंख *sinkh*, and elsewhere सौख *sikh*. In North-East Tirhut it is also सौंख *sink*. This is fixed on supports, which are खिच्छा *hichchha* to the west of the North Gangetic tract and in Patna, and कवाब दानी *kawāb dāni* in South-East

Tirhut, Shahabad, and South Bhagalpur. In Gaya they are चक्का *chakkas*.

448. The *boiling-pot* is देगची or डेगची *degchi*. South of the Ganges and to the west it is also called पत्तीली *patīli* when made of earthenware.

449. The *cup* is रिक्की *rikābi*, the *saucer* रिक्की *rikābi* or कटोरा *katora*, and the *wooden spoon* दोर *doī*, and also in East Tirhut चमच *chamach* or (to the west) चम्मच *chammach*.

450. The large wooden *stirrer* is called कफचा *kaphcha* in North Bihār, दोषा *doā* in North-East Tirhut, and डोंगा *donga* in South Tirhut. In Patna it is दाभा *dābha*, and elsewhere south of the Ganges दबू *dabbu* when made of iron, or कफगीर *kaphgir* (west generally) when made of wood.

451. The *cushion* by which he places the cake on the side of the oven is रफीदा *raphīda*, or in North-East Tirhut गद्दी *gaddī*. The चमत्तगन्ना *hushtagna* is an iron bar hooked at the end, and the चरन्ना *arra* an iron bar flattened at the end. They are used in taking cakes out of the oven. The one is held in one hand, and the other in the other. The two together are called जोड़ी *jorī*, or in Champāran कन्सी *kansi*.

452. The *instrument for making ornamental marks* on pastry is north of the Ganges सँचा *sāncha*; south of the Ganges it is चोकन *chokan* in Shahabad, चोकनी *chokni* in Patna, and elsewhere चोका *choka*.

453. The खुरचनी *khurachni* is an implement for cleaning vessels.

CHAPTER VI.—THE CONFECTIONER.

454. The confectioner is हलुवार *haluāi* in North, and हलुवार *haluāi* in South Bihār. His *fireplace* is चूल्हा *chūlha*, and also in Champāran and South Munger बत्ती *bhatthi*, of which the stoke-hole is मुँह *munh*, and also in Gaya and South-West Shahabad दुवार *duār*.

455. His open *cauldron* is कड़ाही *karāhi* generally, also कड़वार *karhāi*, or तावा *tāwa* in Gaya. Of this the handles are दन्ती *danti*, कड़ा *kara*, or कन्ना *kanna*, with a variant कड़िया *kariya* in South Munger.

456. The *skimmer* is चरन्ना *jharna* in Patna, the north-west, and East Tirhut, चनौटा *chanauta* generally north of the Ganges, पौना *pauna* in the north-west, Tirhut, and south of the Ganges. In Patna it is

also पौनिया *pauniya*, in South Bhagalpur चट्टी *chatti*, and in Gaya, South Munger, and Sāran झंजरा *jhanjhra*. The large stirrer is केंचोचा *keoncha*, and the small stirrer चोलनी *chholni*. In Champāran and North Tirhut it is also खुरपी *khurpi*, and in South Bhagalpur खुरचनी *khurchani*.

457. The wooden rolling-pin is बेलना *belna*, which is worked on a paste-board. This latter is called चकला *chakla* when it is round, and चौकी *chauki* or पट्टरा *patra* when it is oblong. Other names are तखना *takhta* (North-East Tirhut), पिदिवा *pirhiya* (Gaya and South Bhagalpur), and पीहा *pirha* (Gaya and South Munger). The pestle for beating the dough is दावा *daba*, (South-West Shahabad) दाबी *dābi*, or (North-East Tirhut) दाब *dāb*. Other names are गुरदम *gurdam* or मुसद *musad* (Champāran), डपटम *daptan* (Patna), and मुंगरा *mungra* (South Bhagalpur).

458. The spoon is कलहलुल *kalchhul* or in North-East Tirhut करक *karuch*. The brass ladle with a wooden handle for removing the sugar from one vessel to another is दब्बू *dabbu*.

459. The wooden platter for sweets is गिरदा *girda* north of the Ganges and in Shahabad, खोनचा *khoncha* north of the Ganges and in Gaya and South Munger, खानचा *khāncha* in South Bhagalpur, and खाना *khāncha* or डगरना *dagarna* in Patna and Gaya.

460. The brass salver is थारी *thāri* generally, with local variants थरिया *thariya* in Shahabad and East Tirhut and थाल *thāl* in Champāran and East Tirhut. In Sāran and Tirhut it is also called चीपा *chhipa*. The deep brass pan is परात *parāt*.

461. The sweetmeats are exposed on stands called तरौनी *tarauni*, local variants being तरौना *tarauna* in Champāran and South-East Tirhut and तरैनी *taraini* in Champāran. In South Bhagalpur they are टेकती *tekhti*.

462. He has also a wooden basin, called कठरा *kathra*, कठवल *kathwat*, or कडौती *kathauti*; a large ladle, डोहरी *dohri*; and a pair of scales, called generally तराजू *tarāju*, तरजूर *tarjūr*, or टेकौरी *tekauri*. It is also टकौरी *takauri* in Tirhut and the west, and नरजा *narja* in Champāran.

463. बसुधार के दोकान, दादा के पतेहा *haluāi ke dokān, dāda ke phateha*, is a well-known proverb. A *phateha* is a feast in honour of the dead, at which sweetmeats are given away for nothing. When a person wants to get a thing for nothing, which he has no right to expect, the proverb, which means 'a confectioner's shop is not my grandfather's funeral feast,' is said to him.

CHAPTER VII.—THE TOBACCO MANUFACTURER.

464. The tobacco-seller is तमाकुवाला *tamaku-wāla*, तमाकुपरोर *tamaku-phārosh*, or तमाकुबला *tamākul-bāla*. He uses a crushing-lever, डेंकी *dhenki*, with a peg, मूसर *mūsar*, मुसरा *musra*, or समथ *samāth*, fixed in it. It is supported on pillars, खूँटा *khūnta*, खुखा *khuntā*, or (in the west) जङ्घा *jangha* or जङ्घिया *janghiya*, by an axis-pin, किला *killa* or खौता *akhauta*. It falls on a hollow bed called ओखरी *okhri* or ओखली *okhli*, on which the tobacco is placed. When the crushed tobacco is being removed, the beam is supported by a forked stick, which is called टेकनी *tekni*, टेकानी *tekāni*, or (in Shahabad) टेका *theka* or ठकवा *thakwa*, or in Saran टेकवा *thekwa*. In East Tirhut it is called टेकनी *thekni* or अलगनी *alvani*, in Champāran अरगनी *argani*, and in South Bhagalpur डेंगना *thengna* or उचकुन *uchkun*. Sometimes a string, रस्सी *rassi*, is used for this purpose. An illustration of the similar crushing-lever used in pounding bricks will be found opposite § 431.

465. The fragments of tobacco are collected by a broom, जाड़ु *jhāru* or बरनी *barhni*, which is also called कुँची *kūnchi* or कुँचा *kūncha* towards the west and खरहरा *kharhara* in Patna. The tobacco is sprinkled with water from a water-pot, called पनखा *panhanda*, हँदिया *hanriya*, कड़ाही *karāhi*, पियाला *piyāla*, मठकुरी *matkuri*. In East Tirhut it is called अथरा *athra*.

466. The balls of manufactured tobacco are generally पिण्डा *pīlanda* or धोंडा *dhōndha*. Other names are लोहिया *lohiya* (Champāran), गोला *gola* (Saran and the East), लोंदा *londa* (South Munger and North-West Tirhut), लिट्टी *litti* in Patna and South Munger, and पिन्दा *pinda* in Shahabad. टिकरी *tikri* are smaller balls.

467. In a tobacco shop the broad flat metal plates are, north of the Ganges, सेनी *seni*, and south of it खानचा *khāncha* or खोन्चा *khoncha*. The tobacco-pots are भाँड़ा *bhānra*, चरवा *charua*, or चरई *charui*. The cloth covering the stand for the vessels is खरवा *kharua*, जॉप *jhāmp*, or परदा *parda*, and the board on which the tobacco is mixed is पट्टा *patra* or पीड़ा *pirha*. When of stone it is पटिया *patiya*. Instead of पीड़ा *pirha*, पिहिया *pirhiya* or तकता *takhta* may be used.

468. Among the spices used in manufacturing tobacco are जटा मसी *jatu masi*, चरौला *chharila*, सुगन्ध वाला *sugand wāla*, and सुगन्ध कोकिला *sugand kokila*. Plain tobacco is called सादा *sāda*, that which is spiced or scented खंबीरा *khambira* or खमीरा *khamira*, and a mixture of the two दोरस *doras* or दोरसा *dornsa*.

CHAPTER VIII.—THE PIPE-MAKER.

469. The maker of *gurguris* (*vide post*), who is a *कविरा hasera* or brazier, uses a kind of *lathe*, which is called *खरद kharād*. Of this *खूंटा khūnta*, or in South Bhagalpur *कुण्ड kund*, is the block which holds one end of the stem as it is being turned. In it is fixed an iron spike called *गूंज gūnj*. *फरन्ही pharhi* is a piece of iron which keeps the stem in its place as it is being turned, and *बघेली bagheli*, or in South Bhagalpur *बघैला baghaila*, is a piece of wood through a hole in which the stem is passed during the operation.

470. The workman uses the *revolving awl*, *बरग्मा barma*, moved by a bow, *कमानी kamāni*, of which the string is *तस्मा tasma*, *डोरी dori*, or *जोती joti*; a broad *chisel*, *चौरन्वा chaurva*, and a narrow *gouge*, *नहरन्नी naharni*, or in South Bhagalpur *नेहनी nehni*; an *adze*, *बसुला basula*; a small *saw*, *आरी āri*; a *knife*, *छुरी chhūri*; and *files*, *रेती reti*.

471. The maker of hubble-bubbles (*नरियारवाला nariyarwāla*) uses a *रेती reti* (of which the point is *हूर hūr*), *आरी āri*, *बरग्मा barma*, and *गज gaj*.

472. The pipe (*हुका hukka*) is of various kinds—

(1) The *नरियार nariyar* or *नरियाल nariyal*, which is the ordinary country hubble-bubble, in which the mouth is applied to the cocoonut itself. It is smoked principally by Hindus. Of this the stem bearing the bowl for burning the tobacco is *बोता bota* or *गट्टा gatta*. The short smoking-stem sometimes applied to the cocoonut, to save the hands from being blackened, is *निगाली nigāli* or *नर nar*. The bowl is *चिल्लम chillam* or *चिलम chilam*. In South Bhagalpur *पोंगी pongi* is a temporary pipe made of the leaf of a tree. In South-West Shahabad *दममी dammi* is a wooden pipe used by travellers, and *दमन्दाचा damdamācha* a pipe used by women.

473. (2) The other kinds stand on the ground, and are more or less similar to each other in shape. The general name is *गुर्गुरी gurguri* when the smoking stem is joined to a tube rising from the brass bowl, and *गर्गारा gārgara* when it issues directly from the brass bowl. They are generally made of metal or earth. Another name is *फरन्ही pharsi*. The tube arrangement for carrying the

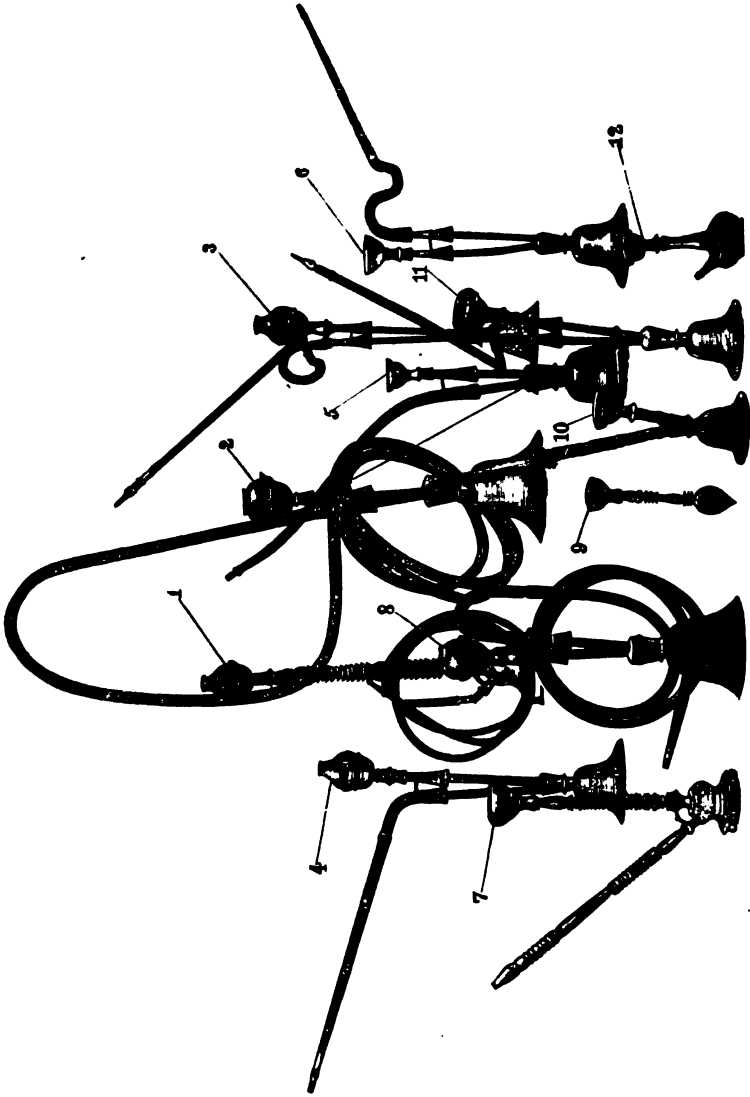

A collection of pipes.

- | | |
|-------------------------------|------------------------------------|
| 1. <i>Penchdār gargara.</i> | 9. <i>Hubble-bubble or pariya.</i> |
| 2. <i>Satak or penchevān.</i> | 10. <i>Tharkiya.</i> |
| 3. <i>Jilebiya kulphidār.</i> | 11. <i>Kohuidār.</i> |
| 4. <i>Kulphidār chaugāni.</i> | 12. <i>Gauriya.</i> |
| 5. <i>Simple chaugāni.</i> | |
| 6. <i>Arhāi khamhā.</i> | |
| 7. <i>Simple gargara.</i> | |
| 8. <i>Phatak pench.</i> | |



bowl is the same in principle as in the cocoon kind. The difference is in the smoking-stems (नेचा *naicha*).

Of these there are—

- (a) कुलफीदार *kulphidār*, that with joints (कुलफी *kulphi*), allowing the mouth-piece to be moved in any direction. A केहनीदार कुलफी *kehanidār kulphi* is a joint like an elbow, and a जिलेबिया कुलफी *jilebiya kulphi* is a twisted joint.
- (b) अर्धा अर्धा *arhāi khamha*, that with two large bends and one small one.
- (c) डेर अर्धा *derh khamha*, that with two bends.
- (d) ठरिया *tharhiya* or ठरिया *thariya*, with a short straight stem—used only by poor Masalmāns.
- (e) चांगनी *chaugāni*, the simplest kind—used by the poor.
- (f) गौरीया *gauraiya*, a simple kind, made of pottery.
- (g) लटक *latak*, which bends downwards.
- (h) चहेदार *chhalledār*, ornamented with gold or silver rings (चहा *chhalla*).
- (i) सटक *satak*, पेचवान *pechwān*, पेंचदार *penchdār*, or फतह पेंच *phatah pench*, are various kinds with the long, snake-like, flexible tube.

CHAPTER IX.—THE PIPE-STEM MAKER.

474. The pipe-stem maker (नेचाबन्द *naichāband* or नेचाबन *naichāban*) uses an *awl*, गज *gaj* or (in Patna) सौंख *sinkh*; a *polishing-knife*, हुरी *chhūri*; a pair of *scissors*, कैची *kainchi* or मेकराज *mekrāj*; a *saw*, आरी *ari*; and a pair of *tweezers*, मोचना *mochna*. He also uses तरुला *tarla* or reed, and चीन *chīn* (*Panicum miliaceum*), a superior kind which comes from Sylhet.

475. For making the longest snake-like stems, पेचवान *pechwān*, a board (तख्ता *takhta*), a string (दोरी *dori*), and a mould (कालिव *kalib*), are also used. The embroidered work on a pipe-stem is called in South Bhagalpur पानदार *pāndār* or मोरसा *morassa*. The silk work on it is सरसर *sarsar* or भरावत *bharāvat*, the flowered silk work on it बुटी *būti*, the silver work on it अल्फी *alphi*, and the ornamental cloth work, उल्लि चीन *ulti chīn*.

CHAPTER X.—THE COTTON-CARDER.

476. The cotton-carder is धुनिवाँ *dhuniyañ*. For a description of him and his instruments, see § 334 and ff.

477. In addition may be mentioned the पटका *patkañ*, which is an instrument for teasing cotton. It is also called गज *gaj* in Tirhut, Shahabad, Gaya, and South Bhagalpur, and साटी *sāti* in Champāran and Shahabad. The पटका *patka* or पटकी *patki* is a simple bow used by village women for carding cotton.

478. A lion once met a cotton-carder in the forest, and seeing his carding-bow, mistook him for a hunter. To avoid being killed, the lion addressed him चाहे बहुजी काने बाज, कहीं बड़े रिहो दुखाना *hāthe dhanuhi kāñhe bāñ. kāhāñ chale Dilli Sultāñ*,—with bow in hand and arrow on shoulder, where is the emperor of Delhi going? The cotton-carder was equally frightened, but at length mustered courage to reply बज में रहना बज में खाना बड़े के बात बड़े पचवाना *bñ men rahna, bñ men khāna. bare ke bāt bare pahchāna*,—although he live and eat in the forest, only a gentleman can recognise a gentleman. These sayings have passed into proverbs, the meaning of which is obvious.

CHAPTER XI.—THE SHOE-MAKER.

479. The shoe-maker is मोची *mochi* or मोची *monchi* in cities, and चमार *chamār* in the country. Among his tools are—

480. The thick iron *pounder* for joining the edges of two pieces of leather which have been previously smeared with paste, which is लोहिया *lohiya* north of the Ganges generally, also लोहंगा *lohaunga* to the west of that tract, and पिटना *pitna* in North-East Tirhut. In Patna, Gaya, and South-West Shahabad it is लोहङ्गा *lohanga*, and in the rest of Shahabad and in South Bhagalpur it is लोहंगा *lehonga* or टिपना *tipna*. In South Munger it is सिंगठा *singtha*. The paste used is लेर *lei*, or to the south-east खर *lai*. In South-East Tirhut it is खरी *khari*. लसम *lasam* is a similar paste made of pounded boiled rice.

481. The *knife* for scraping the surface of the leather is in North-West Bihār रंपी *rāmpi* or रापी *rāpi*. In Tirhut, the west, and South-East Bihār it is also खुरपी *khurpi*. In Gaya it is खुरपा *khurpa*, and in Patna रम्पा *rampa*.

482. The large *awl* is सुतारी *sutāri*, with a variant सुताली *sutāli* in Gaya. To the east it is also लोखर *lokhar*, in Champāran लोखर

lahkhar, and in South-East Tirhut चार *ār*. The awl with a hook at the end for sewing is कतरनी *katarni*. In South Bhagalpur it is डकना *takna*, and in South Munger टिपुनी *tipuni*. The medium-sized awl is मंजोला *manjola* or मंजोली *manjholi*.

483. The horn for grease is सिङ्गा *singa*; south of the Ganges, it is also सिङ्ग *singh*.

484. The *last* is फरना *pharma* or (north of the Ganges and the South-East) कलबूत *kalbūt*; south of the Ganges it is also, in Gaya, काकबूद *kālbūd*, and कलबूद *kalbud* elsewhere.

485. The *wedges* of wood or leather fastened to the last to make it fit are परन्नाहा *partaha* (also in South Munger), or परन्नाहा *partāha* in Shahabad, and पची *pachchi* in the south-west of the same district. In South Munger they are कपचेरी *kapchheri*.

486. The *chisel* for paring the edges of the sole is खुरपी *khurpi*. The sort of wooden chisel for smoothing the surface of the leather is बेंगा *benga* to the east, बेङ्गा *beūnga* north of the Ganges, or बेबोंगा *beonga* or बेबोंगी *beongi* elsewhere south of it. In South Bhagalpur it is पेलन *pelan*.

487. A wooden *block* for beating the leather is हामर *hammar* in South Munger and Gaya and घामर *ghāmar* in South-West Shahabad. The *block* on which the leather is out is पिदिचा *pirkiya*, or in South Bhagalpur सिहा *silla*, and in Saran पिरही *pirhi*.

CHAPTER XII.—THE BLANKET-WEAVER.

488. The blanket-weaver is गरेरी *gareri* south of the Ganges and भेंरिहार *bhenrihar* north of the Ganges; also in East Tirhut मरार *marar*.

489. He uses a simple *loom*. The stick on which the blanket is wound as it is woven is ओखर *okhar* south of the Ganges. North of the Ganges it is सिंजोय *sinjoy*, also सिंजो *sinjo* in Tirhut and कमहार *kamhar* in Champāran. The supports for this beam are खुँटी *khutti*, खूँटी *khūnti*, or (in Gaya and East Tirhut) खूँटा *khūntā*. In South-East Tirhut they are also गाली *gāli* and गली *galli* or गलियारी *galiyāri* in Champāran. In Shahabad the left support is called बरनी *barni*, and the right hand one गाली *gāli*. In the same district the support furthest in front of him is घूरा *dhūra*, and in Champāran घूर *dhūi*.

490. The *beam* to which the web is fastened at the opposite end from the weaver is ओहारी *ohāri*. बें *ben* or बेंव *benw* is a wooden imple-

ment which is passed between the thread of the web to drive tight each thread of the woof. In South-East Tirhut it is also called **हथ** *hatha*.

491. The *movable sticks* placed at intervals to separate the threads of the web are **तगधारी** *tagdhari* in Tirhut and Sāran and **बैलठ** *bailat* elsewhere, except **बैलठ** *bailath* in Shahabad and **बरत** *barat* in Champāran.

492. The *heddles*, or implement for alternately raising and depressing the threads of the web, are **चपनी** *chapni*; also in South-West Tirhut **फाठी** *phatthi*.

493. The wooden *scraper* for removing knots or excrescences from the thread is **खिखोरना** *khikhorna* or **खिखोरनी** *khikhorni* north of the Ganges, also **खिखोरना** *khidhorna* in Champāran. In Patna it is **खिखोरना** *khilorna*, and elsewhere south of the Ganges **खिखोरना** *khilhorna*.

494. The thick iron *needle* is **सूया** *sūa*, or in South Munger **सूज** *sūj*. The *shuttle* is **सरगई** *sargāi* in South Munger and north of the Ganges, and **सेरङ्ग** *serang* or **सेरङ्गा** *seranga* south of it.

495. In Sāran and South-West Tirhut the **बाँड़ी** *bhānri* is a thick bamboo which is placed between the two threads of the warp. In Champāran it is **सासन** *sāsāt*, in South-East Tirhut **साँसर** *sānsar*, elsewhere south of the Ganges **साँसन** *sānsāt*, and elsewhere **चोंगा** *chonga*.

CHAPTER XIII.—THE FANCY SILK OR FRINGE-MAKER.

496. This man is called **पठवा** *patwa* or **पठवेरा** *pathera*. In Sāran he is called **पठवेरी** *patheri*.

497. He uses the **कतरा** *katra* or **कतला** *katla*, a piece of wood with four holes, in which four threads are fixed for winding.

498. The *wooden reel* furnished with a handle is **बटनी** *batni* generally. The *small wooden reel* is **अन्टी** *anti* or **चरक** *charakh*. An optional local name is **गड्डी** *gatti* in South-West Shahabad. **गोडी** *goli*, or in Tirhut and South Munger **पेचक** *pechak*, is a ball of thread. The *winding-stick* is **तोडी** *tōḍi* in Patna, **बेलन** *belan* in Shahabad, and **लतई** *latāi* in North-West Bihār.

499. His *scissors* are **कैंची** *kainchi*. The *coarse needle* for smoothing roughnesses in thread is **सलई** *salāi*, also **टकुवा** *takua* in East Tirhut, and **टेकुवा** *tekua* in Champāran. The *ivory smoother* is **मथार** *mathār*,

or in Sāran मठरणा *matharna*. The large darning-needle is सूया *sūa*. The fine needle is सूई *sūi*, also नममुहिवा *nammuhiya*.

500. The iron hook with a ring which goes round the toe is अंकुरा or अंकुड़ा *ankura*, also अंकुषा *ankusa* and अंकुसी *ankusi* in Gaya and North-East Tirhut. This hook is supported on a stand called थूनु *thānu* in Patna, थौना *thāuna* in Gaya, थला *thalla* in South-West Shahabad, थौना *dhauna* in the rest of the district, and थम *tham* to the east generally.

501. The drum off which the thread is wound is परेता *pareta*, परता *parta*, or परती *parti* in North-West Bihār. The bamboo frame on which the thread is wound is नटवा *natwa* or लटवा *latwa*. In Patna it is नटार *natāi*, and in Gaya and the South-East नटवा *netwa*.

CHAPTER XIV.—THE EMBROIDERER.

502. The embroiderer is जरदोज *jardoj* or (south of the Ganges) कारचोबी वाळा *kārchobiwāla*, and he makes embroidery (कारचोबी *kārchobi*) on the कारचोब *kārchob* or embroidery-frame, on which the work is stretched. This frame is rectangular; and of the parallel pairs of sides, one pair is called (in Patna) समसेर *samser* or (in Gaya and the west) समसेरक *samserak*, and the other तीली *tīli* in Patna, फरद *pharad* in Gaya and Sāran, and पट्टी *patti* in Shahabad.

503. The small needle is सूई *sūi*, and the sewing-awl सुतेमान *sutemān* north of the Ganges, सुतमान *sutwān* in Gaya and Shahabad, सूया *sūa* or बरि सूई *bari sūi* in Patna, Gaya, and South Munger.

CHAPTER XV.—THE DYER.

504. The dyer is रंगरेज *rangrej*, in opposition to the रंगवाज *rangsāj* or painter. In North-West Bihār he is called रंगरेजी *rangreji*.*

505. He uses a vat or pot sunk in the ground for his dyes. This is called north of the Ganges माट *māt*. In Patna it is माँट *mānt*, and to the east माठ *māth*. In Shahabad it is चोड़ *chhorr*, and in the south-west of the district कुण्डा *kunda*. In Gaya and East Tirhut it is कुँड़ *kūnr*, and in South Bhagalpur and East Tirhut गोडी *gohi*.

* This word is often confounded with the word अंगरेजी *Angreji* 'English'; and in jest, or when speaking facetiously, the English in India are called रंगरेज *rangrej*, or 'dyers.'

506. His *half-round pot* is *अथरा athra* or *नाद nād* north of the Ganges, in Shahabad, and South Munger. In South-East Tirhut and South Munger it is also called *कराही karāhi*. In Patna and Gaya it is *हाँरी hānri*, and in South Bhagalpur *करहाई karhāi*.

507. The wooden *filter-frame* on which the cloth is hung like a bag with the dye inside is *मंजी mānji* or *मञ्जी manji* generally. In South-West Tirhut it is *मिरला mirla*, in North-East Tirhut *जोरी jhori*, in Gaya *मंजी mānji*, and in South Bhagalpur *चम्मल chammal*. The string tied to the cloth is *कसन kasan*, and the cloth with the dye inside it in South Munger and Patna *फुलगरना phulgarna*.

508. The *stirring-stick* for mixing the dyes is *दन्दी dandi*, or in South Munger *दन्ता danta*, in South Bhagalpur *टेकती tekhti*, and in North-East Tirhut *लरना larna*.

CHAPTER XVI.—THE WOOD-PAINTER.

509. The wood-painter is *रंगसाज rangsāj*, as distinct from the *रंगरेज rangrej* or dyer. He uses two kinds of *paints*—one *आस्तर astar*, which is a paste made up with chalk and gum, and the other *रोज rogān*, which is made up with resin and oil.

CHAPTER XVII.—THE TIN-MAN.

510. The tin-man (*कालेगर kalaiḡar*) uses a *bellows*, called *भाची bhāchi* south of the Ganges and in East Tirhut; elsewhere it is called *धौकनी dhaukni*. Another name current south of the Ganges is *एक-बन्नी भाची ekhatthu bhāchi*. The two sticks used as handles are north of the Ganges and in South Munger *हत्थी hatthi* or *बन्नी hatthā*, and south of it, and also in Tirhut, *दन्ता danta*. In South-East Tirhut they are also *हत्था hattha*. The bamboo pipe is *चोंगा chonga*, also in North-West Tirhut *नाराया narauna*, in Gaya and Shahabad *नराऊ narāūn*, and in South Bhagalpur *चोंगी chongi*.

511. The *solder* is *रॉंग rānga*, and the soldering-iron *कैया kaiya*. He also uses cotton-wool, *रुई rūi*, and pincers, *सरन्दी sarsi* or *सँडन्दी sanrsi*. The *ठिकड़ा thikra* or *खोरिया khoriya* is the flat tile for melting the solder.

512. The *tin-cutter* is *कैची kainchi*, and he also uses the small *hammer*, *हथौरी hathauri*, and the *compasses* *परन्काळ parkāl*. The *tin-scraper* is *नेहनी nehni* or *लेहनी lehni*; also *खुरचुनी khurchuni* in South Bhagalpur.

513. The *sabra*, *sabri*, or (in South Bhagalpur) *sabal*, is a small kind of *anvil*, made of a bent piece of iron, with one end pointed and stuck in the ground.

CHAPTER XVIII.—THE JEWELLER.

514. The jeweller is *sonār*, or in Gaya *soni*. In Champāran and North-West Tirhut he is *sonargadua* *sonār songarhua sonār*.

515. Amongst his implements are the *tongs*, which are *संक्रुषा saursa* or *संक्रुषी sanrsi*.

516. The *pincers* have various names. Large pincers are *चिमटा chimta* in South-West Tirhut, also *सेहना sehuna* generally to the west; *सोहना sohna* to the east and in Gaya, and *चूंटा chūnta* in Patna. Smaller ones are *चिमटो chimti*, *सेहनी sehuni*, *सोहनी sohni*, or *चूंटी chūnti*. Another kind is *गहवा gahua*, which are the large pincers. Nippers are *गहवी gahvi*, or in South Bhagalpur *गहवी gahvi*. The *कगमुषी kagmuhin* are nippers twisted at the head for holding the crucible in the fire. These may also be called *बगसंक्रुषी bagsanrsi* in North-West Bihār and *बगमुषी bagmuhin* in Tirhut and Champāran.

517. The *wire drawing-pincers*, and the perforated wire plate is *जन्नी jantri* south of the Ganges, in North-West Bihār, and East Tirhut, *जैनी jaintri* north of the Ganges generally, and *जन्नी jatri* in Champāran and North-East Tirhut.

518. The iron needle-shaped tool for making links of chains is *टेकुली tekuli* to the north-west, *टकुवा tukua* to the east and south-west, *टेकुवा tekua* in Saran, Patna, and Gaya, and *टेकुरी tekuri* in South Bhagalpur.

519. The *compasses* are *परकाळ parkāl* or *कम्पास kampās*, or in South-West Shahabad *चलौकी chalāuki*.

520. The *chisel* with a round knob for embossing circular ornamentation is *खलनी khalni*, or in Tirhut *खोलनी kholni*.

521. The *cold chisel* is *चेनी chheni*, and a smaller variety is *कलम kalam* south of the Ganges.

522. The *cutters* are *कैची kainchi*, and also to the south, except Patna, *कतर्नी katarni*.

523. Amongst *hammers* *हथौरा* or *हथौरा hathaura* is the largest. The medium-sized is *मरिया* or *मरिया mariya*, with a variant *मरेया mareya* in North-East Tirhut; in Gaya it is *मथर्नी matharni*. The smallest

is गोल्मुहान् *golmuhān* or गोल्मुहिन *golmuhin*; another name is खोलमरिया *kholmariya* in East Tirhut.

524. The small pointed *anvil* is समन्दान *samdān*. The curved anvil is एकवार *ekwāi*, or in East Tirhut एकबे *ekābe*.

525. The bell-metal *anvil* sunk with several depressions for making *repoussé* work is कंसुला *kansula* in North-West Bihār, कंसला *kansla* in East Tirhut, कंसुला *kānsula* in South Tirhut, कंसला *kānsla* in South-West Bihār, and कसला *kasla* in South Bhagalpur and South Munger.

526. The square-headed *anvil* is निहार *nihāi*, or in Champāran and North-East Tirhut नेहाय *nehaē*, and नहार *nahāi* in South-East Tirhut. In South Bhagalpur it is छिहार *ūhāi*.

527. The *anvil blocks* sunk in the ground are चाहा *chāha* in Sāran and South-West Shahabad. In Champāran and West Tirhut they are टेहा *theha*. In Shahabad they are एकठा *ektha*. In Patna, Gaya, and Tirhut they are परकठ *parkath*, and in South-East Tirhut also पिरगिठी *pirgīthi*.

528. The *blow-pipe* is बकनार *baknār*, or in Sāran बकनल *baknal*.

529. The hollow *cane for blowing up the fire* is नारी *nari*, with local variants नारी *nāri* in Gaya, लारी *lāri* in North-East Tirhut and South Bhagalpur. In South-East Tirhut it is optionally फुकाठी *phukāthi*. The *fireplace* is अंगेठा *angaiṭha* north of the Ganges and अण्ठेठा *anyeṭha* south of it. Another name for this last is बोरन्गी *borsi*. The *fan for blowing up the fire* is पहा *pankha* or पही *pankhi*; also in South-West Shahabad it is बेनियाँ *beniyān*. In North-East Tirhut भट्टी *bhatti* is the dry powdered earth used for cooling the hot metal.

530. The small clay *crucible* is चड़िया or चरिया *ghariya*. It is made of a mixture of clay and rags called in Shahabad कपरोट *kampraut*, and in Champāran कपरोट *kapraut*.

531. An *ingot* not beaten out is कानी *kāmi*, or in Gaya एकवार *ekwāi*. In Sāran it is थक्का *thakka*, in Champāran and North-West Tirhut चहकी *chhalki*, South-East Tirhut गद्दी *gaddi* or थोक *thak* (also in South Munger), in South Bhagalpur थोक *thauk*, and in Tirhut generally except the north-west चिहकी *chhīlki*. A block of silver beaten out flat is चौरसा *chaurasa*.

532. The iron *ingot mould* is परगहनो *pargahni* to the west and परघनी *parghani* in Patna and Gaya. In East Tirhut it is धारा *dhāra*, in Sāran कम धारा *kam dhāra*, and in South Bhagalpur नाही *nāhi*.

533. The *moulds* of various sizes into which metal is beaten are कठकिरा *katkira* north of the Ganges, कठकिरा *kathkira* south of it to the east, ठसा *thassa* in Saran, and ठप्पा *thappa* in Gaya and Shahabad. In Shahabad similar moulds are बहका *bahka*, लहरिया *laheriya*, गोकुल *gokhlu* (also in South Bhagalpur), and मोतिया *motiya*. To the west राहतवार *rahatwār* is a mould in which round articles are beaten into shape, and गुंजरि *gunjri* is a similar smaller one. In the same tract पगरी ठसा *pagri thasa* are milling moulds, such as those in which the edge is given to a rupee. These last are called in South Bhagalpur खीरा बिची *khira bichhi*, बाँच *bānh*, or पगड़ा *pagra*.

534. *Pattern stamps* for ornaments are ठोंसा *thonsa* in Shahabad, ठसा *thasa* in Gaya and South Bhagalpur, ठाँस *thāns* in Patna, and चापा *chhāpa* in South-West Shahabad and South Munger.

535. The कटोरी *katori* is a box or cup for holding scraps of silver. In North-East Tirhut it is called दिबिया *dibiya*, and in Tirhut and to the east सितुहा *situha* or रंगेश्वरी *rangehri*.

536. The *polishing-brush* is बरौची *baraunchhi*. In South-East Tirhut it is also called कुची *kuchchi*. The polishing stone is ओपनी *opni* or पोत *pot*.

537. The *touch-stone* is कसौटी *kasauti*. A *jeweller's wages* is मदार *garhāi*.

CHAPTER XIX.—THE LAPIDARY.

538. The lapidary is बहाक *hakkāk*, or in South Bhagalpur मोहली खोहार *mohli lohār*, and he uses a revolving *grindstone* or सान *sān* or in Shahabad चक्र सान *chakar sān*, made of corundum powder and lac. The bow for turning this is कमाना *kamāna* or (to the west) कमानी *kamāni*. Its props are खूँटा *khunta*, देवाली *dewāli*, or एकथा *ektha*. Its wooden axle is सँखा *sānkha* in Patna and Gaya, लट्टू *lattu* in Shahabad, and कून *kūn* to the east.

539. The *agate burnishers* are घोंटा *ghonta*, and the round ones सिली *silli*; the *pincers*, चूँटी *chūnti* in Tirhut, Patna, Gaya, and the east, चिमटा *chimta* in Saran, and सेहनी *sehuni* in Shahabad; the iron *graver* is सलार *salāi*; the *cutters*, कैची *kainchi*; the small *hammer*, हथौरी *hathauri*; the *anvil*, निहाई *nihāi*; the *pincers*, सँसरी *sānsri*; and the revolving *awl* जिला सान *jilā sān* or खर सान *khar sān*.

CHAPTER XX.—THE SEAL-MAKER.

540. The seal-maker is मोहरकान *moharkan*, and he uses a machine called a चरक *charakh*, of which the principal portion is a revolving awl, बरमा *barma*.

541. The hammer which he uses is मथनी *mathni* or मरिया *mariya*; the stone to which the metal to be engraved is fastened is डेमा *dema*; and the diamond pen is कलम *kalam*.

CHAPTER XXI.—THE GOLD-WASHER.

542. The gold-washer is called निवारिया *niyariya* or निवारिया *niyariya* north of the Ganges and in Patna; elsewhere south of the Ganges he is called सन्धोषा *sandhoa*, and South Bhagalpur निवार धोषा *niyār dhoa*.

543. He uses the कहरा *kathra* or wooden pan for washing the ashes of jewellers' shops. Another name current in Patna and Gaya is कठौती *kathauti*. The ashes are निवारा *niyāra* or नेवारा *neāra*, and they are collected by a scraper, खुरपा *khurpa*, and a broom, कुंची *kunchi* or मूठा *mūtha*. South of the Ganges the पखुरी *pakhuri* is an iron instrument for collecting the ashes.

544. His sifting-pan is चहान *chhattan*, or in Patna and Gaya धकना *dhakna*. In South Bhagalpur it is चौहटा *chauhatta*.

545. His bellows are भाथी *bhāthi*; his blow-pipe, बकनार *baknār*, or in Shahabad बकनल *baknal*; and the earthen pipe of the vessel which remains in the fire, सुसवा *suswa* north of the Ganges and सूंसा *sūnsa* south of it. In Saran it is also नरौसा *naraua*.

546. His pincers are संरुसी *sanrsi*, or in North-West Tirhut सनसा *sansa*; and the iron stirrer सौंक *sink* north of the Ganges and सौंक *sinkh* south of it. Another name for the latter is सलार *salāi* in North-West Bihār.

547. The earthen crucible is घरिया or घरिया *ghariya*, also दीब *diḥ* in Patna and Gaya and अडा *adda* in South Bhagalpur. These crucibles are of two kinds: the first only destroys the dirt, leaving all the metals behind, and is called बगलौती *baglauti*. The second destroys all the baser metals left by the first, and leaves only the gold and silver untouched. It is called पुनहर *punhar*.

CHAPTER XXII.—THE BRAZIER.

548. The brazier is डडेर thathera, but in Shahabad he is also called कडैरा kasera, which properly means a brass-founder. In North-East Tirhut he is डडेरि thatheri. He is famous for his powers of swindling, as in the proverb डडेरि डडेरि नहिं बदला होय thatheri thatheri nahī badla hoy,—braziers don't traffic with each other (for if they did, it would be diamond out diamond).

549. He uses the निहार nihāi or नेहाय nehāē, or anvil. In East Tirhut this is also called लोहाय lehāe, and in Patna, Gaya, and South-West Shahabad पथल pathal. The समदान samdān is the pointed anvil, which is also called in Gaya and Shahabad एकवार ekvāi. The सबरा sabra or, in the south-east साबर sābar, is an anvil round at the top. The circular anvil for shaping the mouth of a vessel is चौका chauka south of the Ganges and बगलभरुवा bagalbhara north of it. South of the Ganges the गेरिया geriya (Gaya) or दुगोड़ी dugori (west) is a sort of wooden anvil or block. The गोली सबरी goli sabri is a kind of anvil for pushing up any indentations. In South Bhagalpur it is called गोलाबार golaābar. The खरवे kharve, or in Shahabad दबठा dabtha, is a kind of anvil on which hollow vessels (गगरा gagra) are hammered out. It stands on the two-legged दुगोड़ी dugori, also called खराट kharāt.

550. The cutters are कैंची kainchi, also कान kāt in Gaya and North Tirhut.

551. The stirrers are—(a) for stirring solder, कैया kaiya south of the Ganges and सरार sarāi north of it; also लोपन lopan in East Tirhut: (b) the iron stirrer for mixing up the flux, पनदेनी pandeni north of the Ganges and Gaya, पेनेनी peneni in Shahabad, and पनकाठी pankāthi (of wood) in South Bhagalpur.

552. The pincers are सन्सी sansi or सँसुंसी sanrsi, also गडुवा gahua; the file रैती reti, and the hammers हथौरा hathaura or हथौरी hathauri, also मथना mathna north of the Ganges and to the west, मरिया mariya in East Tirhut, and घन ghan in North-East Tirhut.

553. The vessel for holding the flux, सोहागा sohāga or पापन pāēn, is कटोरी katori. In South Bhagalpur it is पनवाला panwāla.

554. The bellows are भाँची bhāthi; the crucible, कड़िया or करिया ghariya; the tongs, सन्सी sansi; and the perforated cover for the crucible, ओहार ohār north of the Ganges, South Munger, and South-West Shahabad; also जॉप jhāmp in South-East Tirhut and South

Munger, जाँपन *jhāmpan* or जाँपना *jhāmpna* in Patna and Gaya, चिपौना *chhipauna* elsewhere in Shahabad, and करवाह *karhāi* or मुन्दन *mundan* to the east.

555. The *mallet* is मुँगरी *mungri*. The *scales* are तराजू *tarāju* or तरजूरी *tarjūi*. The *polisher* is चोहनी *chholni* or लेहनी *lehni*. In South Munger it is also नेहनी *nshni*.

CHAPTER XXIII.—THE BRASS FOUNDER.

556. He is कसेरा *kasera*, and in Gaya also तम्हेड़ा *tamhera*.

557. He uses *moulds* of various kinds, called चाँचा *sāncha*, or in Shahabad कामधरणा *kamdharṇa*. His *lathe* is खराद *kharād*, or in Shahabad and South-East Bihār कुन्द *kund*. His large *pincers* are सँकड़ा *sanra* or सन्सा *sansā*. His *crucible* घरिया *ghariya*, of which the mouth is मुँह *munh*. His broad *chisel* is चौरसा *chaurasa* or चौरसी *chaursi*, also लेहनी *lehni* in Shahabad and चेनी *chheni* in the south-west of the same district.

CHAPTER XXIV.—THE BRASS BANGLE-MAKER.

558. The brass (काँसा *kānsa*) bangle-maker (ठठेरी *thatheri* or ठठेर *thatherar*) makes बाँची *bānchi*, which are brass bangles worn by the lower classes. To the east they are called बतिसी *batisi*, and in South Bhagalpur बसी *basti*. When a number of these are worn, those at each end are called बन *ban* or (South-East Tirhut) कचरुकी *kachrukhi* and (Saran) कतरी *katri*. Of these the one highest up the arm is called अगुवा *agua* or अगेला *agela*, and that nearest the hand, पछुवा *pachhua* or पछेला *pachhela*.

559. He uses the following implements. Variants of the names already given in other chapters will not be repeated here:—

560. नेहाव *nehāv*, the anvil; हथौरी *hathauri*, the hammer; सँकड़ी *sanrei*, the pincers; रेती *reti*, the file; चेनी *chheni*, the cold chisel; भापी *bhāpi*, the bellows; घरिया *ghariya*, the crucible; and धाड़ा *dhāra* or चाँचा *sāncha*, the mould, in which कानी *kāni* is the orifice through which the molten alloy is poured.

CHAPTER XXV.—GLASS-MAKER AND GLASS BANGLE-MAKER.

561. These are the सीसा धरेवाला *sisā dharewāla* or glass-manufacturer; the मनिहार *manihār*, who makes glass bangles; and the बुरिहार

or बुड़िहार *churihār* or बुड़िया *churiya*, who makes the embossed ornaments on glass bangles.

562. Their *furnace* is called बड़ो *bhatthi*, of which the opening through which the melted glass is removed is बारा *bāra* north of the Ganges, मोहरा *mohra* in Shahabad, and elsewhere दरवाजा *darwāja*. This is closed by a cover called अलवारी *alwāri* north of the Ganges and in South Munger, ओलवारी *olwāri* in South-West Shahabad, धपौना *dhapauna* in Shahabad, and elsewhere जपना *jhapna*.

563. The earthen *crucible* is ठिकर *thikkar* or ठिकरा *thikra* generally, also कड़ाही *karāhi* in South-East Tirhut, and दिबरा *dibra* in Patna and Shahabad.

564. The *spoon* for putting the glass into the crucible is करकुच *karchhul*. The iron *hook* for taking out the glass is अंकुरी *ankuri* or अंकुरा *ankura* in Patna and the west. अकुरा *akura* in South-East Tirhut, हथ अकुरी *hath akuri* in South Tirhut, हथ अकुरी *hath ukri* in South Bhagalpur, and धरनी अकुरी *dharni akuri* in Champāran. The instrument for turning the glass in the crucible is अकुरा *akura* generally, and कलछुहा *kalchhula* to the west.

565. The *stone* on which the ring is shaped is पत्थर *patthar* or पत्थल *patthal* north of the Ganges, and पथरी *pathri* south of it. The *mould* with a handle for shaping the bangle is कालबूत *kālbūt* north of the Ganges, and कलबुद *kalbud* or सँचा *sāncha* south of it. The handle of this is सरकंधी *sarkandi*.

566. The long iron *poker* on which the glass is melted is सलाग *salāg*; the flat iron instrument for shaping the ring is माला *māla*; and the instrument for widening the ring to the required size बेधवार *bedhwār* in North-West Bihār, बधवारी *badhwāri* in Patna and South Tirhut, and बधरना *badharna* south of the Ganges. The छोटी बेधवारी *chhoti bedhwāri*, &c., or छोटी अकुरी *chhoti akuri*, is the instrument for taking the ring off the mould. In South Bhagalpur it is घारानी *gharanni*.

567. *Other instruments* used by the glass bangle-maker are ठिकठी *tikthi*, which are bamboo slips for holding the bangles in the fire; पन्नी *panni*, leaves of solder; फोकठी *phokāthi* (Gaya and South Bhagalpur), फौफी *phonphi* (West Tirhut and South-West Shahabad), or नरी *nari* (Patna, South Munger, Tirhut, and rest of Shahabad), which is the pipe for blowing up the fire; the अंगेठा *angethā* or अंगेठी *angethi*, which is the fireplace; and चूंटा *chūnta* (Shahabad), चुन्टा *chunta* (Tirhut, Gaya, and South Munger), चुंटी *chūnti* (South Bhagalpur), or चिमटा *chimta* (generally), which is the pincers.

568. In Shahabad a famous maker of glass bangle ornaments was one *Samman Churiya*. It is said that when boys he and a king were pupils in the same school, and each promised that on his marriage he would show the other his wife. Samman married first, and did so. When, however, the king married, he refused to carry out the agreement and show his wife to Samman. The latter thereupon disguised himself as a female bangle-maker, and, gaining admission to the female apartments, sold some ornaments to the queen in the presence of the king, who praised the workmanship, saying the bangles were like ivory ones. Next day the king began to boast of his high character, and how *he* would never allow his wife to be seen by an outside man, when he was interrupted by Samman reciting the following verse, which showed the other how he had been made a fool of:—*समन चुरिया ज गढ़े चो बखी के दान, बाँध पकड़ि रस लेत रौं, बैठे देखें कान Samman Churiya ū garhen jyoñ hasti ke dant, bāñh pakari ras let hain, baithe dekhē kant*,—Samman the bangle-embosser makes bangles like ivory. He held her by the arm, and had the pleasure (of seeing her) while her husband was sitting by.

569. The stamp for making embossed ornaments on the bangle is *साँचा sancha* (Tirhut and the south-east), *करैली करना karaili katna* (Champāran), *ठप्पा thappa* (South-West Shahabad), and *चापा chhāpa* (Tirhut and elsewhere in Shahabad). In Champāran and South-West Tirhut *नोहर togar* is an instrument for embossing.

CHAPTER XXVI.—THE LAC BANGLE-MAKER.

570. The lac (*लाक lakh* or *लाह lah*) bangle-maker is *लाहेरी laheri* or *लाहेरा lahera*. He uses a block of wood with a handle, on which the bangles are fitted, which is called *कुन्द kund*; a *साँचा sancha*, which is a brass mould for embossing ornaments; and a *चुभकी chubhki* (and also to the east *चुभती chubhti*), which is an ivory mould for embossing. His bamboo pipe for blowing the fire is *नारी nari* or *नरि nari*, also *फुकाठी phukāthi* or *लारी lāri* in South Bhagalpur and *फुकाठी phukhāthi* in North-East Tirhut.

571. A bangle, whether of glass or lac, is *चूरी chūri*. The latter variety is also called *लाठी laṭhi*. Of these the thickest, or keeper, which prevents the thinner ones slipping over the hand, is *कंगनी kangni*. The end bangles of a set are *बन्ध band*, or in South Bhagalpur *लरना larna*, and the intermediate ones *सुरकी surki*, and in South Bhagalpur *पहना pahna*.





Potter (Kumhar) at work

CHAPTER XXVII.—THE POTTER.

572. The potter is generally called कुम्हार *kumhār* or कुम्हरा *kumhra*; in the east he is also called पण्डित *pandit*, and in Patna and Gaya also परज्जापत *parjāpat*. In Shahabad he is कुम्हार *kumhār*, and in the south-west of the district कोहार *kohār*. Concerning him there is a proverb, निचिन सुते कुम्हरा, मटिया नठ ले जाव चोर *nichint sūte kumhra, matiya na le jāy chor*,—the potter sleeps secure, for no one will steal clay. His wife is known as कुम्हैनि *kumhaini* or कुम्हैरन *kumhain*, as in the proverb तेली देल ला कुम्हैनि सति *tehi bail la kumhaini satti*,—for the sake of the oilman's ox, the potter's wife has become *suttee*, i.e., she interests herself in other people's affairs.

573. His *wheel* is चाक *chāk*, which is turned by a stick, चकैठ *chakaith*, or in North-East Tirhut चरि *chhari*, on a peg, which is कोला *kila* or किला *killa* to the west, and कुँटी *khūnti* or खुँटी *khutti* to the east. In South Bhagalpur it is, however, सिजा *silla*.

574. The implement for mixing the clay is लेहसुर *lehour* north of the Ganges and लहसुर *lahsur* south of the Ganges generally. In Shahabad it is कटनी *katni*, and in South Bhagalpur पाहा *patta*.

575. The *rammer* for consolidating the clay is पीटन *pitān* when made of wood; when made of earthenware it is पीर *pinr* north of the Ganges generally and in Shahabad, पिरहौर *pirhaur* or पिरहुरी *pinrhuri* in Patna, and पिरहुर *pinrhūr* in Gaya. In South Bhagalpur it is पिनौरी *pinauri*. The clay is smoothed with an instrument called मिलौना *milauna* north of the Ganges and in South Munger, and also मजनी *majni* in South-East Tirhut and South Bhagalpur.

576. The *moulds* for shaping vessels are अथरी *athri* generally. Other names are कठथरी *kathathri* in Patna and करथरी *karthari* in South Bhagalpur. The pots when ready are severed from the wheel by a string called च्हेवन *chhewan*; also चौनी *chhauni* in Patna and च्हेवनी *chhewni* to the east. In South Bhagalpur it is च्हेवनी *chhewno*. Another name is कम्ठी *kamthi* in North-West Tirhut. The सन्चा *sancha* or सँचा *sāncha* is a mould used in making tiles.

577. The *kiln* is आवा *āwa*.

578. The *clay-pit* has many names, viz. चुआँ *chūān* (South-West Tirhut), खँदर *khanrār* (Patna), मटिखान *matikhān* (West Tirhut, Gaya, and Shahabad), मटखना *matkhana* (South-West Shahabad and Tirhut), मटखना *matkhabha* (South Bhagalpur), मटकोर *matkor* (Patna and South

Munger), and मटिहार *matiyar* (South-East Tirhut). Other names are कोहंरगर *kohanrgar* in Sāran and मठखम *matkham* in North-West Tirhut.

579. The earthen pot in which the water which the potter uses while making the vessel is kept is called चकवर *chakwar* in the north-west; also अथवानी *athwāni* in North-West Tirhut, हथवानी *hathwāni* in Gaya and South-East Tirhut, and कदेठ *kadaith* in South Munger. In South Bhagalpur it is चकोड़ी *chakeri* or हथवानी *hathpāni*.

CHAPTER XXVIII.—THE FIREWORK-MAKER.

580. The firework-maker is आतखन्वाज *ataxbāj* or आतखन्वाज *ataxbāj*. In Shahabad and South Bhagalpur he is रवारखन्वाज *rawāiखन्वाज* *rawāiखन्वाज*. In South Bhagalpur गोंड़ी *gonri* is the name of a caste whose employment is to make fireworks.

581. He uses a *grindstone*, which is चक्की *chakki* to the west and in South Bhagalpur, and जाना *jānta* in Tirhut and to the east; also in East Tirhut चकरी *chakri*. In South-West Shahabad it is सिह *sil*.

582. His *ramrod* for ramming the powder is कलबुद् *kalbud* generally, with a variant कलाबूत *kalābūt* in South-West Shahabad. In the rest of Shahabad it is सुम्बा *sumba*, and in South-East Tirhut optionally सुम्हा *sumha* when made of iron. In Sāran it is गज *gaj*. The wooden roller used in making a Roman candle is खोलकड़ा *kholakra*, and in South Bhagalpur also खोलनी *kholni*.

583. His *saw* is आरो *ari*; his *knife*, छुरी *chhūri*. A flat heavy one is बँकी *bānki* in Sāran and Champāran, बँक *bānk* in Shahabad, दाब *dāb* in Tirhut, and दबिया *dabiya* also in the north-east of the same district. His *awl* is बरन्ना *barma*, and his *file* is रेतो *reti*.

584. His wooden *platter* is कठरा *kathra* to the west, अन्ना *athra* in Tirhut, Gaya, and South-West Shahabad, कठौती *kathauti* or कठौत *kathaut* in Patna, Gaya, and East Tirhut, and कठवार *karhāi* in South Bhagalpur.

585. Among the fireworks which he makes are—

- (a) The hand *Catherine wheel*, चरकी *charkhi*, and that which is mounted on a pole, चक्कर *chakkar*, राधे चक्कर *rādhe chakkar* (South-East Tirhut), or चकरवान *chakarvān* (Shahabad).

Of these, the pipes in which the powder is placed are नाळ *nāl*, or to the east लाळ *lāl* or लाला *lāla*, and in South Munger नाला *nalla*. The pipe in which the axle works is also called नाळ *nāl*, &c., as above; also पुळी *pulli* in South-West Shahabad, कुलफी *kulphi* in South Bhagalpur, and in South-East Tirhut दानियाली *daniyāli*. The axle itself is मकरी *makri* or कुची *chhuchhhi* north of the Ganges generally, and also फौफी *phonphi* to the west. The spokes and rim of the wheel are धाँचा *dhāncha* to the west or धँचरी *dhanchri* in Sāran, ठाट *thāt* in Tirhut, मकरी *marri* in South Munger, and मेँकरा *menrra* in South Bhagalpur.

- (b) There are various kinds of *bombs*: amongst them are सुचम्पा *bhuchampa* or सुचम्पा *bhuchappa* (north of the Ganges) or सुई चम्पा *bhuin champa* (south of it), अनार *anār* (generally), कुल्हिया *kulhiya* (north of the Ganges) or लौकी *lauki* (east generally), बमगोला *bamgola* (generally) or गोला *gola* (Champāran and North-East Tirhut), तड़ाका *tarāka* (south of the Ganges), नास पाळ *nās pāl* (generally), दौंतुवा *dāntua* and तोरना *torna* (Shahabad). A long kind of bomb is north of the Ganges चक्का *chakka*.
- (c) The *balloon* is पेटारा *petāra* south of the Ganges, and पेटाहा *petārha* or गोबारा *gobāra* north of the Ganges, to the west. In North-East Tirhut it is उरना पेटाहा *urta petārha*, and in South-East Tirhut उरन पेटाहा *uran petārha*.
- (d) The *rocket* is हवाई *hawāi* or अस्मान तारा *asmān tāra*; also चहरी *chhari* in North-West Tirhut. In South-West Shahabad, Sāran, and Champāran बान *bān*, and in North-East Tirhut जङ्गी बान *jangi bān*, is a species of rocket.
- (e) The *Roman candle* is मकताबी *mahtābi* generally, also दास्ती *dasti* north of the Ganges and गल्लर *gallar* in Shahabad and East Tirhut.
- (f) *Other fireworks* are मकताब *mahtāb*, खजूर *khajūr*, किला *kilā* (a miniature fort, of which the bastions are बुरन्गी *burji*), गज सितारा *ganj sitāra*, कदम गाळ *kadam gāchh*, चादर पड़ाकेदार *chādar parākedār*, सादा चादर *sāda chādar*, चादर *chādar* or (East Tirhut) सौसन के टट्टी *sausan ke tatti*, चाँद चरन्ची *chānd charkhi*, पटेबाज *patebāj*, किरिन *kirin* or

(North-East Tirhut) किरिन चक्कर *kirin chakkar*, कुहुन्दर *chhuchhundar* (West Tirhut and South-West Shahabad), जलेबी *jalebi* (South-West Shahabad), मुरगा *murra* or मुरहा *murha* (South-West Shahabad and Gaya), चन्दर कला *chandard kala* (South-West Shahabad), पढ़ाका *parāka* or (South-West Shahabad) पढाका *patākha* (Chinese crackers), मूढा *mūṛha*, दीपक *dīpak*, जूही *jūhi*, रसपाक *raspāl* (Sāran and Champāran), अरदाना *ardāna* (East Tirhut), देव *deb* or देव *deo* (a flying monster), नटबाज *natbāj* or लरत देव *larat deb* (fighting monsters), कैत बान *kait bān* (a round rocket), फारसी गोला *phārsi gola*, टट्टी लौक फर *tatti līlu phar* (south of the Ganges), घन चक्कर *ghan chakkar* (south of the Ganges), मोर चक्कर *mor chakkar* (south of the Ganges), मोर बाज *mor bāj* (south of the Ganges), पंचरन्धी *pancharkhi* (Shahabad), चौताना *chautāna* (Shahabad), हजार बीन *hajār bin* (Shahabad), चौघड़ा *chaughara* (Shahabad), हुलुक *huluk* (Shahabad), and बतारा *batāsa* (Patna), which is also called अंगारी *angāri* in Shahabad. In South Bhagalpur लौकी *lauki* and पडुका *paduka* have been noted.

CHAPTER XXIX.—THE BOOKBINDER.

586. The bookbinder is in North-West Bihār दफन्दरी *daphdari*, and in East Tirhut दफन्दरी *daphtari*. In South-East Tirhut he is also called कागजी *kāji*. South of the Ganges he is जिल्दबन्ध *jildband*, or in Shahabad जिल्दगर् *jildgar*.

587. His screw-press is सिकड़ा *sikanja*. Another kind of press is मकरी *makri*. The wooden boards for putting between the books in the screwpress are तखता *takhta* or (in Patna and South Bhagalpur) तखती *takhti*. In Shahabad and North-East Tirhut they are पट्टरी *patri*; in South-East Tirhut, पिदिवा *pirhiya*; and in South-East and North-West Tirhut, निष्कर्दा *nishkarda*.

588. The paper-utter is कतरनी *katarni*, or (in Champāran) पढ़ *pārḥ* or पढ़ *bārḥ*. The scissors are कैंची *kainchi*, or in North Bihār also मेकराज *mekrāj*.

589. The iron mallet is हथौरी *hathauri* or मारतौल *mārtaul*, and the awl सूना *sūna* north of the Ganges generally and in Shahabad and South Bhagalpur, सुराकी *surākhi* in Patna, सुलाकी *sulākhi* in Gaya,



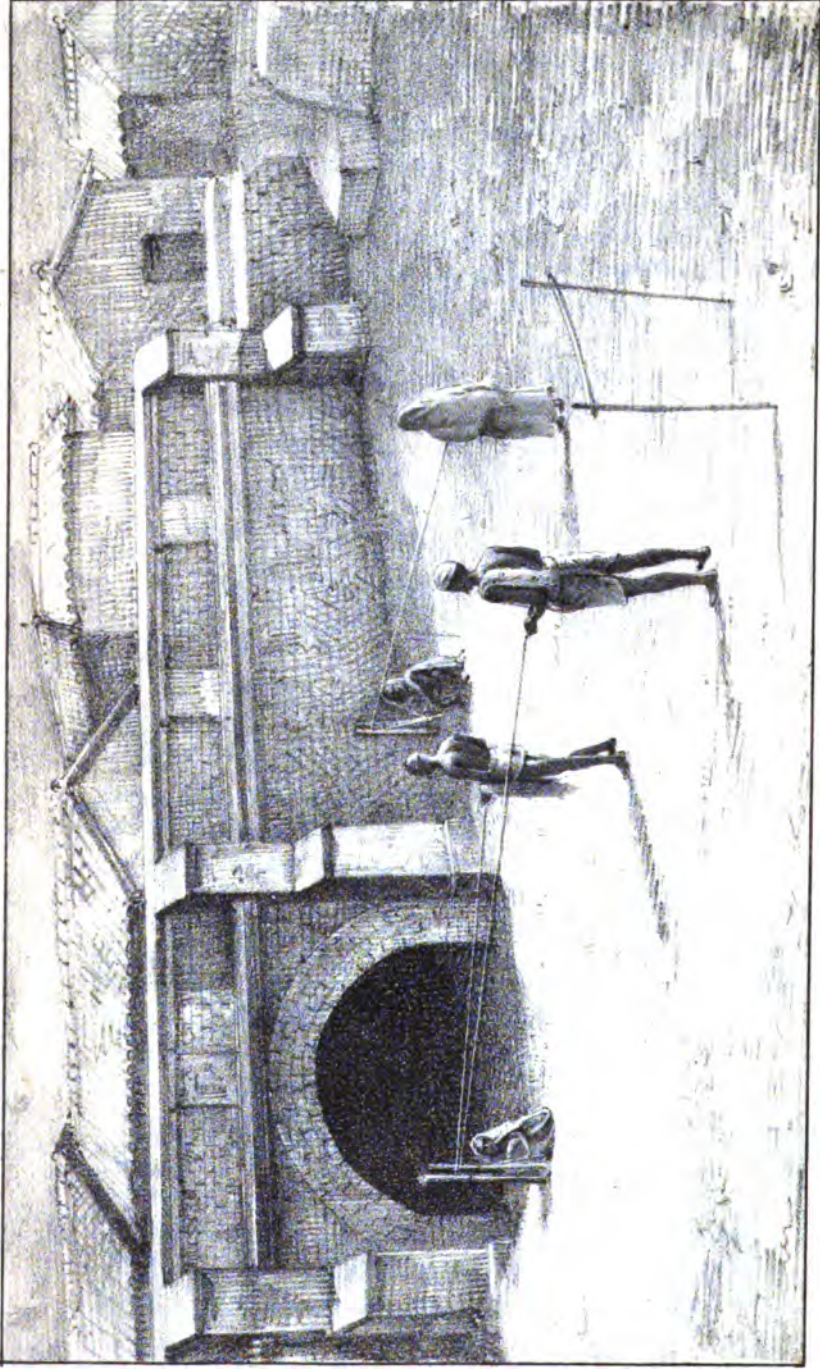

A Native Rope Walk.

सुतारी *sutāri* north of the Ganges, and टेकुआ *tekua* optionally in South-East Tirhut. The needle is सूई *sūi*.

590. The *embossing-wheel*, which is an instrument with a small revolving wheel for embossing the binding, is फिरकी *phirki* in North-West Bihār and South-East Tirhut, चक्की *chakki* in Tirhut and Patna, चक्कर *chakkar* in Gaya and South Bhagalpur, and चक्का *chakka* in Shahabad. Other dies for embossing are फूल *phul* or (optionally in Champāran and Tirhut) थप्पा *thappa*; also जालार *jhalar*, जगन्जीरा *janjira*, and दोस्तूनी *dosūti*.

591. The *cutter* for paring edges is जामा *jhama* north of the Ganges and Patna, and सोहन *sohan* elsewhere. A file for the same purpose is रैती *reti*.

592. The wooden *tool for smoothing the binding* is सल्लेस *sales* (corruption of English 'slice'). It is also called तिल्ली *tilli* or तीली *tīli*, and in East Tirhut कामची *kamchi*.

593. The *leather-scraper* is खुरपी *khurpi*, also north of the Ganges चिहिल्ली *chhilni*. पत्थर *patthar* is the flat stone on which the leather is scraped.

CHAPTER XXX.—THE ROPE-TWISTER.

594. The rope-twister is कज्जर *kanjar* in North-West Bihār and Gaya, and चाँद *chāin* in West Tirhut. In Shahabad and Gaya he is रसबन्दा *rasbanta*. The art of rope-twisting is बटनार *batnāi*.

595. His rope-twisting implement is called फिरनी *ghirni* or फिरनरी *ghirnai*, also घरी *ghari* in South-West Tirhut. Of this the भौरकाली *bhaunrkali* is a flat stone with a hook, to which the rope is fastened as it is being twisted; sometimes a peg, खूँडी *khūndi*, is used for this purpose. The board or bamboo fixed in the ground and perforated with holes, by which the strands, लार *lar*, pass is called गढ़ारी *garāri* north of the Ganges, गरारी *garāri* in Patna, गहरी *gharri* in Gaya, and फिरनी *ghirni* in Shahabad. The strands are fixed to the ends of pegs, बेलन *belan*, which revolve in these holes.

596. The string used to move the machine is फिरना *ghirna*.

597. When cables and thick ropes are made, an instrument called (north of the Ganges) हत्था चरक *hattha charak* and (south of the Ganges) मुँथा *mūtha* is used. This is a grooved block, in the grooves of which the strands are fixed to secure uniformity in the twisting. A man holds it in his hands, and carries it forward as the strands are twisted.

598. A simpler kind of machine is called चरक *charakh* or चरकी *charkhi*. It consists of only a bent wooden handle, दण्डी *dandi*, and a perforated board. The strands are fastened at one end to the handle, and the other ends are twisted by hand.

CHAPTER XXXI.—THE WEAVER'S BRUSH-MAKER.

599. The weaver's brush-maker is called कुंचबन्धवा *kunchbandhwa*. The brush is called कुंची *kunchi*, कुंच *kunch*, &c. (See Chapter on Weaving.)

600. He uses the सँचा *sancha*, which are two moulds for keeping the brush in order while it is being prepared. He beats the brush with a ठोकना *thokna*; and he has a flat piece of wood called पटरी *patri* for keeping the bristles in order.

CHAPTER XXXII.—THE BOW-MAKER.

601. A bow is कामान *kaman*, or in North-East Tirhut कामठा *kamtha*, and its maker is कामगार *kamangar*. He has no special implements.

CHAPTER XXXIII.—THE WEAPON-CLEANER.

602. The सिक्किलगर *sikilgar* or arms-cleaner uses a रण्डा *randa*, or in North-East Tirhut जहाम *jhām*, which is a kind of plane for cleaning off rust; a गुल्ली *gulli*, a piece of hard stone for a similar purpose; कुरन *kurun*, a kind of stone powder. He also uses a सिंघौटा *singhauta* or polishing-horn, a मसकली *maskali* or iron instrument, and गद्दी *gaddi* or thick cloth, both used for varnishing.

DIVISION II.

DOMESTIC APPLIANCES AND UTENSILS.

SUBDIVISION I.

APPLIANCES USED IN THE PREPARATION OF FOOD.

CHAPTER I.—SIEVES.

603. The winnowing-sieve is रूप *sūp* or कोलरूप *kolsūp*. The former is also used for sifting grains of various sizes. It is made of reeds. The latter is used for winnowing only, and is woven of bamboo slips. They are both oblong in shape, and have a low wall round three sides, called in East Tirhut मङ्गरा *marra*. Other names are कोनिया *koniya* (North-East Tirhut) and डगन्ना *dagra* (see § 47) in Gaya, Champāran, and North-West Tirhut.

604. The चालनी *chalni*, or (North-East Tirhut) चालनि *chālani*, is a woven sieve for sifting bran from flour, as in the proverb concerning an extravagant man, कोन पुरखक भेलऊँ गाय, चालनि छे दुहावे जाव *kon purukhak bhelāhuñ gāy, chālani lai duhāve jāy*,—of what man have I become the cow: he has brought a sieve into which to milk me. Again, चालनि दूसल रूप केँ, जनिक्का सहसर गोट हेइ *chālani tūsal sūp keñ, janika sahasar got chhed*,—the sieve, which had a thousand holes, sneered at the winnowing-basket, *i.e.* the pot called the kettle black.

605. The चिलानन *chilcan*, or in Sāran, Patna, and Gaya चिलौन *chilaunj* or चिलौद *chilaund*, and in South Munger चिलौन *chilaun*, is a kind of sieve used for catching fish, and also (according to Crooke) in the North-Western Provinces for straining sugar-cane juice. Other names are आरन्गी *ārsi* or जङ्गा *jangha*, both used in South Bhagalpur, and the latter in North-East Tirhut and the former in Sāran.

606. The चालना *chalna* is a sieve for cleaning grain. Other names are जहर्ना *jharna* south of the Ganges, तर्छी *tarchhi* in Champāran and गुरचालना *gurchalna* (North-East Tirhut).

607. The आंगी *āngi* or आंगिया *āngiya* is a cloth-bottomed sieve for sifting fine flour. It is called हांगी *hāngi* in Gaya and कपरन्धूर

kapardhūr optionally north of the Ganges. In Azamgarh, in the North-Western Provinces, चाँची *āngi* is a leather sieve with very fine holes.

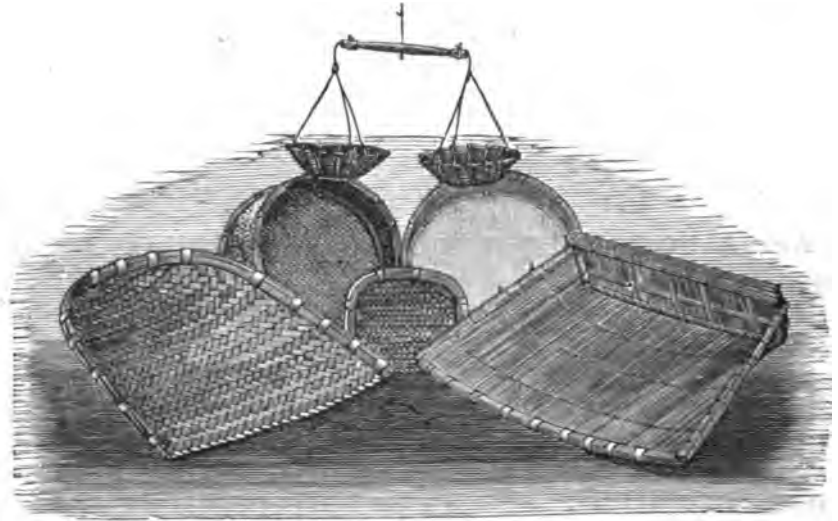

| | | |
|---------|---------|-------|
| | Tarāju. | |
| Chalni. | Supuli. | Angi. |
| Kolsūp. | | Sūp. |

CHAPTER II.—THE PEDAL FOR HUSKING GRAIN.

608. The whole apparatus, and also the movable *beam*, is called दँकी *dhenki* or (in Shahabad) दँका *dhenka* or डेका *dheka* and (in Sāran) दँकुल *dhenkul*.

609. The *pillars* on which the beam rests are जङ्घा *jangha* in North and East Bihār, जाँघा *jāngha* in Shahabad, and जँघिया *janghiya* in North-West Tirhut. In Tirhut and the west they are खूँटा *khūnta*, in Patna and Gaya खुँटा *khunta*, and in South Bhagalpur and South Munger खुँटा *khutta*. In South-West Shahabad they are called खम्भा *khambha*.

610. The *peg* in the beam which crushes the rice is मूसर *mūsar* to the south and west, and मुसरा *musra* in Tirhut, Patna, Shahabad, and South Bhagalpur. In Sāran another name is पहारवा *paharua*. In South Munger, Patna, and Gaya it is समठ *samāth* or समँठ *samānth*, and समौवा *samaua* is the iron ferule round its tip.

611. The *axle* is generally **बखौत** *akhaut* or **बखौता** *akhauta*, local names being **मंजा** *mānjha* in Champāran and North-East Tirhut, **बेलनी** *belni* in North-West Tirhut, and **दण्डा** *danda* also in North-East Tirhut. In Patna it is **रङ्गी** *ranki*, in South Bhagalpur **असकदार** *askalāi*, and in South-West Shahabad **सारा** *sāra*.

612. The *hollow wooden bed* in which the rice is crushed is **बोखरी** *okhri* north of the Ganges, or as a local variant **बोखर** *okhar* in North-East Tirhut and the north-west. **बोखरी** *okhri* and **भुन्दो** *bhundo* occur also in South Bhagalpur, and **उखरी** *ukhri* in South Munger. In South-West Shahabad it is **कान्डी** *kānri*, in the rest of the district **भुरिया** *bhuriya*, in Gaya **भुईबोखरी** *bhuiñokhri*, and in Patna **भुङ्गी** *bhunrki* or **घुण्डी** *ghundi*. The stick used for stirring the grain while it is being pounded is in Gaya and South Bhagalpur **ठेकरा** *thekra*.

613. The *hand-rail* which the workman grasps is **अस्थम** *astham* north of the Ganges and **थमनी** *thamni* or **अलगनी** *algani* in South Bhagalpur. It is **तंगनी** *tangni* in Patna and South Munger, also **अरानी** *arāni* in South Munger, and **हत्थी** *hatthi* in Gaya. In Shahabad a rope (**रस्सी** *rassi*) is used.

614. The *pedal* or place where the worker rests his foot is **पौदर** *pauḍar* in Patna and Shahabad, **पखहर** *pachhahar* or **पखार** *pachhār* in Sāran and Champāran, **पुखड़ा** *puchhra* in North-East Tirhut, **पखौरा** *pachhaura* in South-West Shahabad, **पखुवा** *pachhua* in South Munger, **पुखिया** *puchhiya* in South Bhagalpur, **पोखी** *ponchhi* in Gaya, and **लतमरा** *latmara* in North-West Tirhut. The pit into which this is depressed is in Gaya **गोरपौरी** *gorpauri*, and in South Bhagalpur **गत्तो** *gatto*.

615. This implement is practically the same as the lever for breaking bricks, for an illustration of which see § 431.

CHAPTER III.—THE PESTLE AND MORTAR USED FOR HUSKING GRAIN.

616. The *mortar* is **बोखरी** *okhri* generally, local variants being **बोखर** *okhar* in North-East Tirhut and Shahabad, **बोखरा** *okhra* in South-West Shahabad, and **बोखली** *okhli* in Gaya. In Patna an optional name is **कुरदान** *kurdan*, and in Saran **धनकुडी** *dhankutti*.

617. The *pestle* is **मुसर** *mūsar* to the west and **समाठ** *samāth* to the east. In Patna both words are used.

618. The iron *ferule* at the bottom of the pestle to prevent it splitting is *साम* *sām*, or in Patna, Gaya, and the south-east *समौषा* *samaua*, and in Sāran optionally *समियाँ* *samiyāñ*.

CHAPTER IV.—THE HAND GRINDING-MILL.

619. This is known as *जाँत* *jānt*, *जाँतवा* *jantwa*, or *जाँता* *jānta*. This is worked by two women. The smaller kind, used for breaking pulses and worked by one person, is *चकरी* *chakri* generally, or *चकी* *chakki* to the west. North of the Ganges *चकुला* *chakula* is a medium-sized one.

620. The *upper stone* is *उपरौटा* *uprauta*, and the *lower stone* *तरौटा* *tarauta*, and also south of the Ganges *तलौटा* *talauta*.

621. The *handle* of the large variety is *हाथरु* *hāthar* in South-East Tirhut, and elsewhere *हाथरा* or *हाथड़ा* *hathra*. In Shahabad it is *जूषा* *jaa*. That of the smaller variety is *खूँटी* *khūnti*. The *axle* is *किला* *killa* or (in South-East Tirhut) *कील* *kil*; and the *feeding channel*, *मुँह* *munh* generally; also *गाली* *gāli* in Shahabad, Gaya, and South Bhagalpur, *गाली* *gāli* in Sāran and North-East Tirhut, *गालौसी* *galausi* in Champaran, *खोरख* *khōñichh* or *गलियारी* *galiyāri* in North-West Tirhut, *गटो* *gatto* in South Bhagalpur, and *घरिया* *ghariya* in South-West Tirhut.

622. The *handful of grain* poured into the mill is *जौक* *jhink*, local variants being *जौका* *jhinka* in Sāran, Patna, and South-East Tirhut, and *जौका* *jhika* in South-East Bihār. In South Bhagalpur it is also *लप्पो* *lappo*.

623. The *wooden seat* on which the woman sits is *पीड़ा* *pirha*. A local variant is *पीड़ी* *pirhi* or (East) *पिदिवा* *pirhiya*. A similar mud seat is *बैसनी* *baisni*, or in Champaran *बैठनी* *baithni*, and in South-East Tirhut *बैसन* *baisan*. In South Munger it is *बैसका* *baiska*, and in South Bhagalpur *बैसको* *baisko*.

624. To roughen the stone with a chisel is north of the Ganges *टांगव* *tāngab* or *टूंगव* *tūngab* to the west and *कूटव* *kūtab* to the east. South of the Ganges, to the west, it is *कूटल जाइब* *kūtal jāib*, and to the east *कूटाएब* *kutāēb* or *कूटिदेब* *kūtideb*. The man who does this is called *जानकूटा* *jankutta*. He uses a chisel, *खेनी* *khēni*, and a hammer, *थपुषा* *thapua* or *थपौरी* *hathāuri*.

625. The act or profession of grinding corn is *पिसान* *pisān*, *पिसवान* *piswan*, or in Champaran *पिसना* *pisna*, and in Gaya *पिसार* *pisāi*,



MILL-STONE FOR PESTLE AND MORTAR FLOUR-MILL
PULSES (*Chakri*) (*Jant*)

Lith. by Hazz. Chandrar. Ghosal, Student, Govt. School of Art Calcutta.

Printed by Abdool. Rohim Govt. School of Art Calcutta



and its wages *pisāi*. A well-known proverb is *जाहरी पटना जोड़ा एक जान*, *jāichhi patna jora ek jānt*,—‘I go to Patna for a pair of mill-stones,’ something like a Newcastle-man going to London to look for coals.

CHAPTER V.—THE GRINDSTONE FOR SPICES.

626. This is *सिलान्त* *silant* or *सिलौट* *silaut*, and in Saran *सिलान्त* *silāwat*; also in Patna, Gaya, and South-East Tirhut *सिल* *sil*. To the south-east it is also *पाटी* *pāti*.

627. The stone roller used with it is *लोहा* *lorha* to the west and *लोही* *lorhi* to the east. In Patna another name is *बहा* *batta*.

CHAPTER VI.—THE ROLLER FOR MAKING PASTE.

628. The *rolling-pin* is *बेलना* *belna*; also *बेलन* *belan* in Patna.

629. The *pasteboard* is *चौकी* *chauki* to the west and *चकला* *chakla* to the east. In South-East Tirhut another name is *चकोला* *chakola*, in Gaya *चौकला* *chaukla*, and in North-East Tirhut *चक* *chak* or *चाक* *chāk*.

630. The dry flour sprinkled on the board to prevent the paste sticking is *परन्थन* *parthan* generally, with local variants *परन्थनी* *parthani* to the west and *पलेथन* *palethan* in Patna and South Munger. In South-East Tirhut it is optionally called *मारा* *māra*.

SUBDIVISION II.

DOMESTIC FURNITURE.

CHAPTER I.—STOOLS.

631. Stools made of bamboo or reeds are *मोड़ा* *monrha* when large, and *मोड़िया* *monrhiya* when small.

632. When made with a woven twine seat, a wooden framework, and four legs, they are called *मचिया* *machiya*. Another name is *मचोला* *machola*, current in Champāran.

633. When it has three legs, it is called *तिपार* *tipāi* north of the Ganges, and *तेपार* *tepāi* or *तेपई* *tepaī* south of it. In Shahabad a three-legged stool is called *मैंच* *mench*.

634. A wooden stool is, according to size, चौड़ा *pirhā* (large), चौकी *pirhi* or पिदि *pirhi* (smaller), and पिदिवा *pirhiya* (smallest).

635. The wooden platform for sitting, sleeping, or bathing is, when large, तखतपोष *takhatpos*, and when small पट्टरा *patra*. चौकी *chauki* is used for both large and small kinds.

CHAPTER II.—THE BED AND COT.

636. A bed or cot is चाट *khāt*, कटिया *khatiya*, or पलङ्ग *palang*. When an ordinary bed, it is specially called चारण्यार *chārpāi* or चरण्यार *charpāi*, and when a cot, कटोला *khatola* or कटोली *khatoli*; also in South-East Tirhut कहुला *khalula*. Another name is पलंगिया *palangiya* or पलंगरी *palangri* in Shahabad and South Munger; another name is सजेवा *sajea* or सेजिया *sejiya*, which is used principally in poetry.

637. The pillow is तकिया *takiya* or तकेवा *takea*, also गेरुवा *gerua* in East Tirhut and सिहानी or सिहानी *sirhāni* in Tirhut and the west. The bolster is बासीस *bāsis*, बलिवा *balista*, or (in South-West Shahabad) बिलवा *bilasta*. The side bolsters are बगली तकिया *bagli takiya*, and the heavy thick bolster for resting the back against is मसनद *masnad* or गौ तकिया *gau takiya*. The bed clothes are बिहाखोम *bichhāon*, बिहौना *bichhauna*, or गेटम *getam*. The mattress or its equivalent is तोसक *tosak*. In Tirhut ओहाखोम *ochhāon* or ओहौना *ochhauna* are the bed clothes over the body. A patchwork quilt, &c., worn by the poorer orders is गेंद्रा *gendra*, (also in Champāran and to the east) खेंद्रा *khendhra*, or सोजनी *sojni* in South Bhagalpur, Patna, and Gaya, खेनरा *khenra* or सुजनी *sujni* in Saran and West Tirhut, लेंद्रा *lendra* in Shahabad, and गुद्रा *gudra* or लेवा *lewa* to the west generally. In South Bhagalpur it is भोथरा *bhothra*. See also § 731.

638. The legs of the bed are पाया *pāya*, पावा *pāya*, or पावा *pāwa*. The side pieces are पाटी *pāti* or पट्टी *patti* generally, also पासी *pāsi* in Tirhut and South Bhagalpur. The end pieces are चूर *chūr* or चूल *chāl*. The head of the bed is सिहाना *sirhāna* or सिहानी *sirhāni* north of the Ganges, also मुरथारी *murthāri* in North Tirhut and सिरमा *sirma* in North-East Tirhut. South of the Ganges it is सिरहाना *sirhāna* (Shahabad also सिरहान *sirhān*) or मुरथारी *murthāri*, also सिरवाँसी *sirwānsi* in South Bhagalpur. The foot of the bed is गोरथारी *gorthāri* or गोरथरिया *gorthariya*. In Shahabad it is गोरथार *gortār*, and in Saran गुन्थारी *gunthāri*; also गोनथारी *gontāri* north of the Ganges generally and in South-West Shahabad, पथौनी *pathāuni* in South-East and

पथाना *pathāna* in North-East Tirhut. South of the Ganges we find optionally पैताना *paītāna* in Shahabad and Patna, पौताना *pautāna* (also in South Munger) or पोथानी *pothāni* in Gaya, and पौथाना *pauthāna* in South Munger.

639. The *network* at the bottom is बिनाक *bināwat* or बिनार *bināi*, or in East Tirhut गोरार *ghorāi*. In Patna and Gaya it is बीनन *binan* or बिनाउ *binaut*, in Shahabad बिनान *bināw*, and गोरन *ghoran* in South Bhagalpur and South Munger. When this is made of one string, the bed is said to be एकबधिया *ekbadhiya*; of two strings, दोबधिया *dobadhiya*; of four strings, चौबधिया *chaubadhiya* (west); and of six strings, छबधिया *chhabadhiya*. In South Bhagalpur the words एकगोटिया *ekgotiya*, दुगोटिया *dogotiya*, चरगोटिया *chargetiya*, and चगोटिया *chagotiya* are used. In South Munger they are एकजोरिया *ekjoriya*, &c. The strings at the bottom by which the netting can be tightened at pleasure are ओरचन *orchan* or ओरद्वानी *ordawāni* in Tirhut and the west. In Saran and Patna they are ओरचन *orchan* or ओद्वारन *odwāin*. In the east they are अरान्च *arānch*. Other local names are ओनचन *onchan* in South-West Shahabad, ओदारन *oddāin* in Gaya, अद्वारन *ardwāin* to the east, ओदान *odān* in South Munger, and बाध *bādḥ* or गतान *gatān* in North-East Tirhut. The thick rope at the foot to which the netting is tied is सिधुवानी *sidhwāni* in the north-west; also मन्ही *mānhi* in Champāran. In South-East Tirhut it is अजुवारन *ajwāin*. In Patna it is मरै *māin*, in Gaya मेवार *meār*, in South Munger मारन *māin*, and in South Bhagalpur बान *bān* or मेन *main*. Elsewhere it is also called ओरद्वानी *ordawāni*. The string tied to the side as the netting is being made is बरुवा *barua* in the north-west and south. In Tirhut and the east generally it is ओका *ojha*, or in South Bhagalpur also जमौवा *jamāua*. When the netting is finished this string becomes useless, and villagers believe that if it be thrown across the door of a house the members of that house will quarrel amongst themselves. The सोग *sog* or सोक *sok* are the large spaces in the netting along the frame of the bed.

CHAPTER III.—THE WEIGHING-SCALES.

640. The *large fixed scales* are रातल *rātal*, local variants being रातुल *rātul* in Shahabad and रातन *rātan* in North-East Tirhut. In South Bhagalpur they are काँटा *kānta*, which elsewhere means the small scales. Another name in the same place is मन्काँटा *mankānta*. The small scales are तराजू *tarāju*, local variants being तरजूरी *tarjūri*

in the north-west, तरजू *tarju* in East Tirhut and South Munger, and तरजूषा *tarjūa* in South Bhagalpur. Other names are कान्ठा *kānta* and टकौरी *takauri* in the west and Patna and Gaya, and परिवानो *pariyāni* in Patna and Gaya, which principally refer to goldsmith's scales. In South Bhagalpur तूल *tūl* is a weaver's scale for weighing thread or cotton.

641. The *pans* of the scale are पल्लरा or (in Patna and Gaya) पल्लड़ा *palra*. In South Bhagalpur they are also called डलनी *dalni* or पल्ला *pulla*.

642. The *strings* of the scale are called तन्नी *tanni* (except in the east), a local variant being तानी *tāni* in Gaya. In the east they are जोती *joti* or (in South Munger) जोता *jota*. In Patna optional names are डोरी *dori* and बाधा *bādha*.

643. The *weights* are बटखरा *batkhara* or बाट *bāt*. The *make-weight* put into one scale to make the balance true is पसंगा *pasangha*, local variants being (East Tirhut) पासंग *pāsangh* and (Patna, Gaya, and South Bhagalpur) पसंगा *pasanga*. In Patna and Gaya and South Munger it is also called धारा *dhāra*.

644. The *beam* of the scales is दण्डी *dandī*. In the south-east the beam of a jeweller's scale is निचो *nitti* or निको *nikti*. The *indicator* is सूर *sūi*.

645. A *false balance* is नेवत *newat* or नेवता *newta* to the west and in Gaya. In East Tirhut it is लेवत *levat*, and in Champāran नवन्ता *nawta*. In South-West Shahabad it is जीवत *jiyat* or जीता *jita*, and so also in Gaya and South Munger. In Patna and Gaya it is झुकता *jhukta*, and in South Bhagalpur जोती *joti*.

CHAPTER IV.—NETS.

646. A small fisherman's net is जाल *jāl* or जाली *jālī*, and a महाजाल *mahajāl* is one of a larger size. North of the Ganges and in Shahabad a कुरैल *kurail* is a net fixed in the water with six sticks and worked by one man. In South Bhagalpur it is खरैल *khairail*. A similar net with three sticks is बिसारी *bisāri* north of the Ganges and in South Munger; also बिसरी *bisri* in Champāran, and बिसर *bisār* in Champāran, Gaya, and South-East Tirhut. In North-East Tirhut, however, it is called खन्सारी *khansāri*, and in South Bhagalpur चौंधा *chaundha*. A casting-net is फेकैल *phékail* in Patna, Gaya, and Saran, खेप *khep* to the west, and घुमौषा जाल *ghumaua jāl* in Tirhut and South Munger; also

in North-East Tirhut बडियार *khapiyar*. In South Bhagalpur it is फेका *phaka*. The iron or earthen sink-balls attached to it are बडियार *batiwan* and बडियार *batwan* to the west, and पौंडी *paunri* in North-West Tirhut. In South Bhagalpur they are भौंडिया *bhontiya*. A net attached to two poles and worked by two fishermen is डौंडी *donri* in Patna, Gaya, and the west, and डौंड *donr* in Champāran. Other fishing-nets are गनेली *ghanali* and पसर *pasra* to the west, and गिरगिरा *girgira*, a small variety, used in Gaya and the south-east. In the same district and in Champāran ओका *oka* is a bag dragged through the water for catching fish. In Champāran and North-East Tirhut टापी *tāpi*, in Shahabad टाप *tāp*, and in South Bhagalpur अरसी *arsi*, is a kind of bamboo fish-net, and गँज *gānj* or गँजी *gānji* is a horn-shaped basket for catching fish. The man who works the last is called गजवाह *gajwah*. In this connection may be mentioned a fish-trap used in Gaya called चिलौंद *chilaund* (see, however, § 605). Fish caught in this are kept in a pit, called आपा *āpa*. A kind of pit used for catching fish is called in Gaya फरका *pharka*. A net for catching birds is घनी *ghani* north of the Ganges; also फान *phān* or फानी *phāni* in Champāran and Tirhut, and फाँदा *phānda* in Shahabad. South of the Ganges the बडियारी *batiyāri* is a net used in the daytime, and चतर *chātar* one used at night for catching birds.

647. North of the Ganges the जोला *jhola* or जोली *jholi* is a net used by cartmen for feeding bullocks. To the west it is जोरी *jhori*, and elsewhere south of the Ganges जला *jalla*. जाला *jāla* is a net for carrying grass. A local variant is जला *jalla* in Saran and South Munger. In South Bhagalpur it is कपार *kapāi*.

648. To the west (including Patna and Gaya), and in Tirhut, सिकार *sikhar* is a net for hanging up pots, &c., in a house. Other names are सौका *sinka* (Patna and Gaya), सीका *sika* (Saran, Champāran, and the east generally), and सीक *sik* also in North-West and South-East Tirhut. खँजी *khānji* in North-East Tirhut is a net for holding fruit.

649. The stick or rope for hanging up clothes is अरगनी *argani* in Saran, Champāran, Patna, and North-East Tirhut, अरगनी *argani* in Shahabad and Tirhut, अरगनी *argani* in Tirhut (optionally), Shahabad, Patna, and Gaya, and रेगनी *regni* in Shahabad. Other names are टंगना *tangna* in Patna, Gaya, and South Munger, टंगनी *tangni* or दौनी *dauni* in Patna and South Bhagalpur, and जियता *jiyata* in

Shahabad. A frame used for the same purpose is *ठहरौ thatri* to the west and *चठहरौ chhatri* in North-West Tirhut.

650. A cord net for carrying goods on the head is *जखखरौ jalkhars* in West Tirhut and to the north-west, and *जाखी jāli* in Shahabad, South Munger, and Tirhut. In the south-east it is *जख जाला jalla*.

651. The net used by bearers with the sling pole (*बहंगी bahangi* or, in North-East Tirhut, *बहिंगा bahinga*) is generally *सिखर sikhār*, but *सिका sika* in the south-east, *सिखा sikha* in Gaya, and *सिक sik* (optionally) in North-West and South-East Tirhut.

CHAPTER V.—THE PAD USED FOR SUPPORTING WATER-POTS &c., ON A WOMAN'S HEAD.

652. This is *बिठा bittha*, *बीठा bitha*, or *बीठो biho* to the west and in West Tirhut. In Patna, Gaya, and the south-east it is *नेठो netho* or *नेठवा nethua*. Another name is *गेंदुवा genrua* to the west and in Gaya and South Munger, *गेंदुली genruli* in Patna and Gaya, and *गेंदुली genruri* in Tirhut. Another name (only noted north of the Ganges) is *बिंरिया binriya* in Champāran, *बिंरुकी binrri* (a small kind) in Sāran, *बींरुकी binro* in East Tirhut, and *बिंरुवा binrua* in Tirhut generally; yet another name is *लजुरी lajuri* in South-West Shahabad.

CHAPTER VI.—THE STICK.

653. The ordinary long stick is *लाठी lāthi* (also *लठ lath* in Patna). Other names are *लौर laur* (north of the Ganges) or *लाउर laur* to the west, and *सठका sathka* north of the Ganges. The butt end of this is *हुरा hūra* north of the Ganges and in Patna, *हुररा hurra* in Shahabad and the south-east, *हुठवा huttha* in Gaya, and *गोवा goa* in South Munger optionally.

654. *सोंग sonta* or *सोटा sota* is a stout short stick. It is also called *दख्ख दanta*, and in Champāran *दख्खी दantauka*. A thin stick is *खड़ी khari*, and to the west, including Patna and Gaya, *गोजी goji*. Other names are *खखन khākan* in Champāran and North-West Tirhut and *खखनी khakni* in South Bhagalpur. A thick walking-stick is *दंग dang*, and also, to the west, *लबदा labda*, and a similar one, used principally by old or lame men, is *थेंगुनी thenghuni*. This last is also called *थेंगुरी thegunri* in Champāran and West Tirhut, *थेंग theng* or *थेंगुनी thenguni* in Shahabad, and *थेंगा thenga* in the south-west of the

same district. In South Bhagalpur it is *थेंगनी thengni*, and elsewhere *थेंगी thengi*. *बेसाकी besakhi* is a crutch. In Shahabad *पटङ्कक patkan* is a walking-stick. A piece of split bamboo used as a stick is *फट्टा phattha*, *फट्टी phatthi*, or *फराठी pharāthi*. It is also called *बंसफटा bansphatta* or *बंसफेंटा bansphenta* in Patna and Gaya, and *बत्ती batti* in the south-east. A heavy stick is *बोंग bong*, or to the north-west *बजर बोंग bajar bong*.

655. The following Hindi lines in praise of the stick are very popular in Shahabad, a district famous for its club-men :—

छाठी ऐसी चीज है सदा राखिये सङ्ग ।
 नदी नार अगाध जल तहाँ बचाओ सङ्ग ॥
 तहाँ बचाओ सङ्ग अपठ कुनो को मार ।
 दुरजन दावागीर उस को मसक आर ॥
 कह गिरधर कवि राय लिख भेजिये पाती ।
 कमर धिये तरवार हाथ में धिये छाति ॥

Lāthi aisi chij hai sadā rākhiye sang,
Nadi nār agāh jal tahān bachāo ang.
Tahān bachāo ang jhapat kutto ko mār,
Durjan dāwāgīr us ko masak jhār.
Kah Girdhar kabi rāy likh bhejiye pāti,
Kamar diyē tarwār, hāth men diyē lāthi.

A stick is the kind of thing you should always have with you :
 If the water in a river is too deep, you can save yourself by it.
 You can also at once save yourself by hitting dogs with it.
 And if you meet a wicked enemy you can dust (*lit. trans.*) his head
 with it.

Saith Girdhar, the prince of poets, write a letter
 Telling him to wear a sword in his belt, but to carry a club in his
 hand.

CHAPTER VII.—BOXES.

656. North of the Ganges *सङ्कुच sanukh* or (in Sāran and South Munger) *सङ्कु sandukh* is an ordinary box. South of the Ganges it is *सङ्कु sanduk*, and in Patna and Shahabad *सङ्कु sanuk*. A small box is *कान्तोर kantor* or *बाकस bakas* (box). South of the Ganges it is *सङ्कुची sandukchi* or *सङ्कुची sanukchi*, the latter chiefly in Shahabad and the extreme east. *पौवा paula* or *पौवी pauti*, or (in South

Bhagalpur) चीनी *paunti*, is a little box made of bamboo slips, and मोना *mona* (Champāran) or मीनी *maunni* are similar ones made of straw or of bamboo slips.

657. पेढारा *petārha* or पेढारी *petārhi*, and also south of the Ganges पेढारा *petāra* or पेढारी *petāri*, is a light travelling box or basket for clothes, &c., carried by a man on a sling bamboo, as in the proverb थाकल बारद के पेढार भारी *thākal barad keñ petār bhāri*,—for a tired bullock even a basket is too heavy. Other names are सखारी *sakhāri* in South-East Tirhut and जाम्पी *jhāmpi* south of the Ganges and in Champāran. The sling bamboo is called बहंगी *bahangi*, or in North-East Tirhut बहिंगा *bahinga*; also सुला *sula* in Champāran and North-West Tirhut, and सिकपटरी *sikpatai* in East Tirhut.

658. The दिबिया *dibiya* is a small box for jewelry or other valuables. In Patna and Gaya it is दिबा *dibba*, and in Saran also डीबा *diba*.

659. The चुनौटी *chunauti* is a box for carrying the lime (चूना *chūn* or चुना *chunna*) used with betel. In Champāran and North-West Tirhut it is called चुन्दा *chunha*.

660. The box in two parts for holding betel, &c., is पनबहा *panbatta* or बेलबन्ना *belahra*. Local names are पनौटी *panauti* (Shahabad), पनबहौ *panbatti* (Champāran and South-East Tirhut), बेलबन्नी *belahri* (Patna and Gaya), and बिरबन्ना *birhara* (Champāran and East Tirhut).

661. The box in which the अबन्ना *abtan*, or cosmetic which is rubbed on the bride at a wedding, is kept is डोकी *doki* in Shahabad, and सोगिला *sogila* or सन्सोगिला *sansogila* in the south-east. Elsewhere it is माला *māla*, &c. See below.

662. The box used by women for carrying red lead is सिंधोरा *sindhora* when large, and कीया *kiya* when small. The box in which they carry the vermilion which they put on the parting of their hair is इंगरौटी *ingrauti* or कियौरी *kiyauri*. It is also हिंगोरी *hingori* in North-East Tirhut and सपरी *sapri* in South-East Tirhut.

663. A माला *māla*, मलवा *malwa*, or मलिया *maliya* is a box for holding oil. It is also called मलसी *malai* in North-East Tirhut, तेलबन्ना *telhanda* in Patna and Gaya, and तेलबन्ना *telbhāna* in Shahabad.

CHAPTER VIII.—METAL VESSELS USED IN COOKING AND ORDINARY DOMESTIC PURPOSES.

664. The vessels ordinarily used by Hindus are as follow:—

तसला *tasla* or तसलावा *taslawā*, made of brass (पीतल *pitāra*), a round vessel used for boiling rice. About two *ser*s of rice can be cooked in it.*

665. तसली *tasli*, a similar vessel of smaller size. In Shahabad it is called तौली *tauli*.

666. बटुवा *batua* or बटु *battu*, a vessel made of alloy (फूल *phul*, कसकुट *kaskut*, or (Gaya) भरिच *bharith*). This is used for cooking rice, and about a *ser* of rice can be cooked in it. It is comparatively higher and narrower than the तसला *tasla*.

667. बटलोही *batlohi* or (north of the Ganges) बटुली *batuli*, a smaller similar vessel, used for cooking pulse or meat.

668. पतिली *patili* of copper (तांबा *tāmba*) or alloy. It has a narrow flat mouth, and is used for boiling meat.

669. हन्दा *handa*, हान्हा *hānrha* (Patna and the south-east), खरखन्दा *kharkhanda* (Gaya), or खंकरखन्दा *khānkhrāhra* (Champāran and North Tirhut), is a very large copper vessel for boiling rice. When used by mendicants (फकीर *phakir*) it is called by them टोकना *tokna*.

670. तामी *tāmi* or तमिया *tamiya* is south of the Ganges a large brass vessel, broad at the bottom, for cooking pulse at marriages, &c.

671. कड़ाह *karāh*. This (to the north-west and in Gaya) is a large iron pan capable of boiling as much as twenty *ser*s of rice.

672. बरगुना *barguna*. This (in North-West Bihār) is a small brass vessel with an erect rim for boiling rice, pulse, &c.

673. कराही *karāhi* or कड़ाही *karāhi*, and to the east and in Champāran लोहिया *lohiya*, an iron or brass broad shallow pan with handles (करा or कड़ा *kara*), generally used for cooking vegetables.

* About this vessel there is a story. Once upon a time all the people of Bhojpur, in Shahabad, were robbers. When a traveller passed through one of these villages, they used to seize his cooking-pot, saying "तसला तोर की मोर *tasla tor ki mor*,"—"Is the pot mine or yours?" If the traveller replied "मोर मोर," "mine," they would set upon him and beat him and rob him of the vessel by force. If he said "तोर तोर," "yours," they used, on his own admission, to take it from him and let him go peaceably. Thus, in any way, they plundered him. Hence the saying तसला तोर की मोर *tasla tor ki mor* has passed into a proverb, of which the application is easy to see.

674. बरगुना *bahguna*, an iron or brass cooking-pot with straight edges and a handle.

675. तमचेड़ी *tamheri*, a round copper vessel.

676. तवा *tawa*, तावा *tāwa*, or (Patna and Gaya) तार *tāi*, an iron griddle plate.

677. कठोरा *katōra* to the south and north-east, कचोरा *kachōra* in Sāran and Champāran, दुब्बा *dubbha* in Sāran and Champāran, बाटी *bāti* in Tirhut, and मेंहिबाटी *menhibāti* in South-East Tirhut, is a vessel used for eating from, with a projection at the bottom on which it stands.

678. The तस्तारी *tastari* (north of the Ganges and in Gaya, Patna, and South Munger), चिपुली *chhipuli* to the east and in Patna, जाम *jām* in Patna, Gaya, and the south-east, and कस्तारी *kastari* in Shahabad, is like the कठोरा *katorā*, except that it is flat-bottomed, and has no stand.

679. In the south-east the जरन्का *jharka* is a deep pan for eating; the कचन पूरी *kanchan pūri*, a shallow one; and the अग्राई *agrai*, one with the edges straight and short.

680. The थारी *thāri* or थरिया *thariya*, also चोपा *chhipa*, and (in Patna and Gaya) खोरी *khori*, is a flat pan from which food is eaten. The मलंगिया थारी *malangiya thāri* has straight sides, and the मिरजापुरी *mirjāpuri* has curved ones.

681. परात *parāt*, a large flat pan like the थारी *thāri*, except that its sides curve gradually up to the top.

682. थंठी *thān̄thi* or तंठी *tān̄thi* is a dish like the थारी *thāri*, but made of bell-metal (काँसा *kānsa*).

683. दब्बु *dabbu*, a brass or iron spoon, of which the bowl is deep and broad, principally used at marriages.

684. कलछुल *kalchhul* or करछुल *karchhul* is a spoon. कलछा *kalchha* in South-West Shahabad means an iron spoon, and कलछी *kalchhi* in Sāran, Patna, and Gaya a brass or iron one.

685. North of the Ganges and in Shahabad चनौटा *chhanauta* or जरन्का *jharna*, and in Patna, Gaya, and the south जंजरा *ghanjhra*, is a cullender or iron sieve with a handle. In North-West Tirhut it is also called चनौटा *sanauta*, and in North-East Tirhut जंज *ghānjh*.

686. पौना *pauna* or (South-East Tirhut) पौनिया *pauniya* is an iron cullender or straining-ladle.

687. The लोटा *lota* is used for drawing water and drinking.

688. The गेरुआ *gerua* or बखर *hathhar* north of the Ganges, Patna, Gaya, and Shahabad, also सोबरना *sobarna* in North-East Tirhut, and जारो *jhāri* in Champāran, Patna, Gaya, and to the south-east, is a kind of *lota* with a spout (ढोंडी *tonti*). It is generally made of a white alloy (पूरा *phūl*). The माधव सिङ्गी *mādhav singhi* (North-East Tirhut) is a kind of drinking-vessel invented by Mādhav Singh, a former Mahārāj of Durbhanga. It is shaped like a globe surmounted by a funnel. The globe has a spout, and the whole stands on a pedestal.

689. तमचा *tamcha* north of the Ganges, and जारो *jhāri* south of it, is a similar vessel made of red alloy (कस्कट *kaskut*). Both the last two are used for drinking.

690. अब्खोरा *abkhora* or अमखोरा *amkhora* is a drinking-vessel, the sides of which are broader towards the mouth, and it is provided with a stand (गोदिया *goriya*) at the bottom. It is also called खोरा *khora*. In Gaya दुब्बा *dubbha* is a large cup, and in South Bhagalpur लोडकी *lotki*.

691. गिलास *gilās* (glass), similar to the last except that the sides are straight or only slightly curved. It sometimes has no stand, and is flat-bottomed. It is, in fact, modelled closely on the lines of a European peg-tumbler, but is of metal.

692. बट्टा *batta* (Patna, Gaya, and North-East Tirhut), a kind of large metal cup. बाटी *bāti* is a small one.

693. गगरा *gagra*, or (in Ohampāran and Tirhut) तमघैल *tamghail* or तमघैला *tamghaila*, (in Gaya) बसनी *basni*, and (in Champāran, Patna, and to the south-east) कालसी *kalsi*,—a copper or brass vessel used for drawing water from a well.

694. डोल *dol* or कुंड *kūnr*, an iron vessel for drawing water from a well.

695. लोहरा *lonhra* or लोहरौ *lonhri*, a small iron pan. In the south-west also used for drawing water from a well, like डोल *dol*. North of the Ganges it is also called लोहिया *lohiya*.

696. चोंद *chhonrh* or मदुका *matuka*, a copper or brass vessel for storing water in.

697. The सुराही *surāhi* or सोराही *sorāhi* is used for keeping water. जलधारी *jaldhari* (North-East Tirhut) is a water-pot.

698. **बफन्तावा** *aphtāba* or **बफन्तावा** *aphtāya*, a water-ewer used for washing.

699. **चिहिनची** *chilimchi* north of the Ganges, **चिहिनची** *chiliphchi* in North-West Tirhut, **चिलमची** *chilamchi* south of the Ganges, and **सिलफची** *silaphchi* amongst Muhammadans, used for washing.

700. **सरपोस** *sarpos*, **डकन्ना** *dhakna*, or **डपन्ना** *dhapna*, a cover for other vessels.

701. **मलिया** *maliya* or (Gaya) **मलिया** *malhiya*, a small cup for holding oil. Sometimes it is made of wood.

702. **दीवड** *diyāt* or **दीवड** *diwāt* or **चिरकन्दान** *chirakdān* (north of the Ganges), **बरद्वान** *baradwān* (Gaya), and **चिरागन्दान** *chirāgdān* (Shahabad and South Munger), is a lamp-stand. In North-East Tirhut it is **दीवडि** *diathi*, and in South Bhagalpur **द्विपरा** *dipra* or **द्विपरा** *dipahra*.

703. **चिमन्टा** *chimta* or **चिऊँठा** *siūnthā*, also **चूँटा** *chūntā*, a pair of small tongs used for arranging the fire or turning over cakes on the griddle.

704. **संरुची** *sanrsi*, or (to the east) **बावली** *bāwli*, or in South-East Tirhut **बगुली** *buguli*, tongs used for removing the pot (**बहुली** *batuli*, &c.), from the fire.

705. **खोरना** *khorna* or **खोरनी** *khorni*, also **सरार** *sardī* (North-West Tirhut), **उकन** *utkan* (Patna, Gaya, and South Munger), **एकठा** *ekthā* (Champāran), and **लोपन** *lopan* (East Tirhut), is an iron or wooden poker. **पिक्कर** *pihkar* (Shahabad) is a wooden poker.

706. **रसान जिहा** *imām jista* or (to the south-west) **हावन दस्ता** *hāwan dasta*, or (South-West Shahabad) **निमदस्ता** *nimdasta*, or (South Bhagalpur) **हमाम दिहा** *hamām dista*,—a pestle and mortar for grinding spices, &c.

707. **पिकन्दान** *piikdān* or **पिकदानी** *piikdāni*, also to the west and south **उगलन्दान** *ugaldān*, (in Patna and Gaya) optionally **चिरमिची** *chirmichchi*, and (in South Bhagalpur) **पिरगन्दान** *pirigdān*, a spittoon. To the east and in Patna it is also **पिरिकन्दान** *pirikdān*.

708. **पनन्दान** *pandān* or **पनबट्टा** *panbatta*,—for keeping betel.

709. **लेवा** *lewa*, or in Patna and Shahabad **लेवन** *lewan*, and in the south-west of the district **लेव** *leo*, is ashes plastered on the cooking-pot to save it from fire.

710. The handful of straw, &c., used for cleaning metal vessels is **लूँडा** *lūnra* or **लुँडा** *lunda*. In South-East Tirhut it is optionally **नूँडा** *nūnra*. In South Bhagalpur it is **नूँडो** *nūro*, and in South Munger **नुँडा** *nunda*.

711. Musalmāns generally use the following vessels :—

पत्तीळा *patīla*, a large copper vessel for cooking rice.

पत्तीळी *patīli*, **देगची** *degchi*, or **डेगची** *degchi*, a similar vessel smaller in size.

देग *deg* or **डेग** *deg*, a somewhat larger pot for boiling.

बधन्ना *badhna*, the same as the Hindu **लोट** *lota*, but with a spout.

बधन्नी *badhni*, a similar vessel of smaller size.

कडोरा *katora*, similar to the Hindu vessel, but made of copper.

पियाळी *piyāli*, a cup.

पियाळा *piyāla*, similar to the last, but larger.

रिकाची *rikāchi*, a saucer.

तबाक *tabāk*, **जिब्हा** *jibbha* in Champāran, or **तबाक** *tabāk* south of the Ganges, a broad flat washing-vessel.

चिमन्डा *chimta*, &c., the same as used by Hindus.

सरपोस *sarpos*, **डकन्ना** *dhakna*, or **डकन्ना** *dhapna*, cover for other vessels.

चिलिमची *chilimchi*, &c., the same as for Hindus.

अपतनावा *aphtāva*, the same as for Hindus.

तसत *tasat* or (when smaller) **तसतरी** *tastari*, a broad flat dish.

सेनी *seni* or (in South-East Tirhut) **सेन** *sain*, a broad shallow tray.

गगरा *gagra*, &c., as for Hindus.

लगन *lagan*, a large vessel for storing water.

कराची *karāchi*, &c., the same as for Hindus.

खरन्ना *jharna*, **खनौटा** *chhanauta*, &c., as for Hindus.

पनवडा *panbatta*, &c., as for Hindus. The **हुसुन्दान** *husundān* or (Gaya) **कुत्ता** *kutta* or **कुत्ती** *kutti* is similar, and contains additional compartments for lime.

खासन्दान *khāsān*, for keeping *pān* or betel, with a cover.

The **खिलबट्टी** *khilbatti* is used for keeping ready rolled up betel leaves, with the nut and lime inside ready for use (**खिल्ली** *khilli*).

पिकन्दान *pikdān*, &c., as for Hindus.

सोराही *sorahi*, &c., as for Hindus.

Lamp-stands, viz., **फतिल सोज** *phatil soj*, and in Saran also **पटोल सोज** *patil soj*, of brass; **चिरागन्दान** *chirāgdān*, of wood; **हीवट** *hīwat*, &c. (see Hindu articles) of iron; and **बदवान** *badwān*, of bamboo slips.

तावा *tāwa*, &c., as for Hindus.

दस्त पनाह *dast panāh* or **दस्त पना** *das pana*, tonga.

सिंखचा *sinkhcha* or **सीख** *sikh*; also north of the Ganges **गज गज** *gaj*, a spit.

दबू *dabbu*, as amongst Hindus.

CHAPTER IX.—EARTHEN VESSELS.

712. The number of these is very large, and varies in each district. The following list does not profess to be exhaustive. It is in alphabetical order.

713. When a new earthen vessel is taken into use, it must first be used by a member of the family and not by one of the servants of the house; otherwise it is considered impure. This is considered as a dedication of the article to family use. To dedicate an article thus is **उदाहब** *urāhab*, or in South Bhagalpur **उदाहब** *urhāēb*, and in Saran **उदाहब** *urāōl* or **अँवासल** *añwāsak*.

अरहाया *arhaiya*, a vessel containing two and a half *sers*. In North-East Tirhut it is made of brass.

अथरा *athra*, a pan for making dough. **अथरी** *athri* is a smaller one used (in Gaya) for holding water, washing clothes, and roasting poppy-flower cakes.

अधकार *adhkar* (east), a vessel used in distilling.

अबखोरा *abkhora*, a drinking-vessel.

कँटिया *kantiya* or **कटिया** *katiya*, a little vessel with a long neck. Cows are milked into it.

कत्ती *katti* (Patna, Gaya, and Saran), or **गत्ती** *gatti* (Shahabad), a round potsherd used by boys in playing.

कपट्टी *kapti*, a kind of cup.

करई *karai* (South Munger), a water-vessel with a spout.

करन्वा *karna* (Śāran), an earthen vessel in which milk is boiled, also (North-West Tirhut) used for holding curds.

करन्वा *karwa* (West Bihār and South Bhagalpur), a water-vessel with a spout.

करधिया *karahiya*, for boiling milk = कराही *karāhi*.

कराही *karāhi* (north of Ganges) an earthen pan in which clarified butter (घू *ghyu*) is cooked or milk boiled.

कलन्वा *kalsa*, कलन्वी *kalsi* = a चैला *ghaila*, especially when ornamented with lime and colours at weddings, &c.

कस्तारा *kastara* (south-east), a saucer for holding curds.

कस्तारी *kastari* (south-east) = तस्तारी *tastari*, *q.v.*

कूड़ *kūnr* (west and Patna), a large vessel for holding grain and food.

कूड़ा *kūra* (north of Ganges), an earthen vessel in which sweetmeats or balls of rice mixed with sugar (कसर *kasār*) are given to daughters when going to their father-in-law's house. In South Bhagalpur it is कुचा *kunda*.

कुधिया *kurhiya* (South Bhagalpur), a small vessel for milk.

कुचा *kunda* (Champaran, Shahabad, and South Bhagalpur), a large flat jar. See also कूड़ा *kūra*.

कोचा *koha* or पतुकी *patuki*, a small round wide-mouthed vessel for curds, or for cooking. कोधिया *kohiya* (Gaya) is a smaller variety.

कपन्दा *khapra*, tiles.

कपन्दी, कपन्दी *khapri*, or (North-East Tirhut) कापरि *khāpari*, an earthen griddle for making bread or parching grain. When used for parching grain it is made by breaking off the top of a चैला *ghaila*, but that used as a griddle is specially made by the potter. In South Bhagalpur it is also called चरिया *chariya*.

कपन्दीड़ी *khaprauri* (Gaya and West Tirhut), a pot for removing the afterbirth, &c., when a child is born.

कलन्ची *khalchi* (Shahabad), a little platter.

कापरि *khāpari*. See कपन्दी *khapri*.

कावा *khāwa* (South Munger), an earthen cooking-vessel.

कोची *khikhi* (Tirhut), a vessel for holding oil.

कम *khām* (Patna), a large flat jar.

खोर *khor*, खोरा *khora* (Tirhut, Patna, and the south-east), a long round earthen vessel used by saltpetre-makers (नोनिया *noniya*) for holding the mother liquor; also (to the east and in Gaya) a large jar used for various purposes.

गगरी *gagri*, a vessel used for drawing water.

गती *gatti*,—see कती *katti*.

गमला *gamla*, a flower-pot.

गुरकी *gurki*, a drinking-vessel, especially for drinking spirits.

घड़ा *ghara*,—see घैला *ghaila*.

घरिह *gharil*,—see घैला *ghaila*.

घरिया *ghariya* (Shahabad), a drinking-vessel.

घुचुची *ghuchchi* (Sāran), a little dish with a narrow neck.

घुरिली *ghurili*, a little vessel with a narrow neck.

घैला *ghaila*, घैली *ghaili*, घड़ा *ghara*, or घरिह *gharil*, a vessel for holding or drawing water. (See बसनी *basni*, दाबा *dāba*.)

चट्टी *chatti* (Patna and Gaya), an earthen cooking-dish.

चड़िया *chariya*,—see खपड़ी *khapri*.

चरुआ *charua*, चरुई *charui* (south of Ganges), a vessel for holding grain or for cooking = चेरुआ *cherua*.

चिकनी चाँड़ी *chikni hanri*, a vessel for cooking vegetables, pulse, &c. After using it for several months it becomes polished and durable owing to the oil and butter cooked in it.

चिराक *chirāk* (South Tirhut and the west), चिराग *chirāg*, a lamp-saucer.

चिलम *chilam*, the bowl of a pipe.

चुकरी *chukri* (south-east), a drinking-vessel.

चुकनी *chukni* (Gaya), a small earthen jar.

चुकर, चुकर *chukkar*, a vessel with straight sides and a very short neck, used for drinking.

चुका *chukka*, a drinking-vessel.

चेरुआ *cherua*, चेरुई *cherui* (north of the Ganges and east), an earthen cooking-dish or for holding grain = चरुआ *charua*.

चाँपी *chaumpi* (Patna and Gaya), an earthen vessel in which milk is boiled.

बनान *chhanān* (Tirhut, Patna, and Gaya), a vessel with cloth at the top for straining toddy.

बौंद *chhonrh* (to the west), a large earthen jar.

बौंदी *chhonrhi* (north-west), a vessel for keeping water or grain.

बाजा *jāla*, a water-jar.

बाज्जर *jhajjhar*, a croft for keeping water.

बाबन्ही *jabhi*, an earthen vessel into which cows are milked.

भारी *jhāri*, a vessel with a long spout.

तरिया *tariya* (Champāran and the east), a small oil-pot.

टाड़ *tār*, टाड़ा *tāra* (Gaya), an oil-pot. A smaller variety is टाड़ी *tāri*.

हँदा *tuhīya*, a drinking-vessel.

टूबाँ *tūān*, टूँ *tuin* (Patna and Gaya and South Munger), a drinking-vessel with a spout.

तेहरा *tehra* (Gaya and South Bhagalpur), a kind of pot for milk.

टौंटिया *tontiya*, a tile used as a water-spout at the eave of a house.

डिलिया *thiliya*, a vessel used for drawing water.

डबरी *dabri*,—see डिबरी *dibri*.

दाबा *dāba*, a vessel used for drawing water smaller than a बसन्ही *basni* and a घैला *ghaila*. In South-East Tirhut, used for boiling milk.

डिबरी *dibri*, and also in Shahabad डबरी *dabri*, same as बसन्ही *basni*, but smaller.

डकना *dhakna* or (east) डाकनि *dhākani*, a cover for other vessels. डकनी *dhakni* is a smaller one.

डिमका *dhimka* (South Bhagalpur), a saucer used as a covering for other vessels.

तरकही *tarkatti*, the vessel in which palm-juice (ताड़ी *tāri*) is collected at the foot of the tree.

तबाक *tabāk* (Patna and Gaya), a little platter (generally of iron).

तसन्तरी *tastari*, a saucer used by Muhammadans. When made of brass, also used by Hindus. Cf. कसन्तरी *kastari*.

तार *tāi* (south of Ganges and Champāran), a griddle for making bread; a kind of shallow pan, with an edge for lifting it up by.

तेलहँदी *telhānri*, तेलहँदा *telhanda*, a vessel for holding oil.

तेलाय *telāy*, an earthen vessel for cooking oil or clarified butter चू (ghyu).

तौला *taula* (north of Ganges, Gaya, and the south-east), a large earthen dish for cooking.

थपरी *thapri* (Patna and East Tirhut), a vessel for measuring milk.

थाल *thāl*, a platter.

दबकन *dabkan* (Gaya), a saucer used as a cover for other vessels.

दवात *dawāt*, an ink-stand.

दहेंकी *dahenri* or (Patna and Shahabad) दहकी *dahri*, for holding tyre (दही *dahī*).

दियरी *diyari* (north of the Ganges and south-west), दियारी *diyāri* (North-East Tirhut), a very small lamp-saucer.

दिउरी *diuri* or दिउली *diuli*, a very small lamp-saucer.

दीप *dip*, a lamp-saucer.

दीया *dīya*, a lamp-saucer.

दीरी *dīri* (south-east and Gaya), a very small lamp-saucer.

देग *deg*, a cauldron.

नदिवा *nadiya*, for keeping tyre (दही *dahī*).

नदोर *nadoi* (Gaya), an earthen cooking-vessel.

नरिया *nariya*, a kind of tile (चपड़ा *khapra*).

नाद *nād* or (east) लाद *lād*, a large earthen basin or bowl used as a feeding-trough and for other purposes.

पमिळा *patila* (Sāran, Patna, and South Munger) or पमौला *patila* (Sāran and Gaya), an earthen cooking-vessel.

पतुकी *patuki* (west), a small round wide-mouthed vessel for keeping tyre or for cooking.

पमचोरा *panchora* (south of Ganges), a vessel used in distilling.

परगहा *parchha* (West Tirhut), a large jar for water.

परार *parāi* (South-West Shahabad), a saucer used as a cover for other vessels.

परिया *pariya* (Patna), a saucer used as a cover for other vessels.

पिठौचा *pitaua* (Patna), a small earthen pan.

पियाला *piyāla*, पेचाला *peāla*, a drinking-cup.

फुकी *phuchchi* (South-East Tirhut), a vessel for measuring milk.

फरी *phari* (South Bihār), a saucer used by Musalmāns in feasts of the brotherhood.

बधन्ना *badhna*, a water-vessel with a spout.

बरका *baruka* (South Tirhut), a drinking-vessel.

बसन्नी *basni*, a vessel for holding or drawing water, smaller than a घैला *ghaila* and larger than a दाबा *dāba*.

बहन्ना *bahna* (Patna and South Munger), a large flat jar.

बिहार *bithār* (Patna), a large dish.

भभन्का *bhabhka*, a vessel used in distilling.

भरका *bharuka* or भरकी *bharuki*, a drinking-vessel.

भाँड़ा *bhānra* or भाँड़ *bhānr*, a vessel with a neck for milk or clarified butter (घू *ghyu*).

भुरका *bhurka*, भुरकी *bhurki* (in Tirhut), a drinking-cup.

भोजहरौ *bhojahri* (south-east), an earthen dish used by Musalmāns at marriages.

मँगरा *mangra*, the tiles along the ridge of a roof.

मटका *matka*, and also (south of the Ganges and in Champāran)

मटुका *matuka*, an earthen vessel for holding water or grain.

मटुका *matuka* = मटका *matka*, *q.v.*

मरन्तवान *martabān*, मरन्तवान *martawān* (south of Ganges), मिरन्तवान *mirtawān* (north of Ganges), an earthen vessel with a wide mouth ornamented with lac (लाह *lah*).

मलवा *malwa* (West Tirhut, Shahabad, and South Munger) or मलिया *maliya* (North-West, West Tirhut, Patna, and South Bhagalpur), a vessel for holding oil. It is equally often of wood or metal.

माँट *mānt* (Gaya), a large flat jar.

मिरन्तवान *mirtawān* = मरन्तवान *martawān*, *q.v.*

मिठिया *mitiya* or मेठिया *metiya*, a round vessel with a short neck for water.

मेठिया *metiya* = मिठिया *mitiya*.

मेटा *meta* (South Bhagalpur and to the west) = मिठिया *mitiya*.

मेटी *meti* (South Bhagalpur), for holding tyre.

मौन *maun*, a vessel for holding date-juice.

रामकरवा *ramkarwa* (South-East Tirhut and Champaran), a drinking-vessel.

रकेबी *rakebi* = रेकाबी *rekābi*, *q.v.*

रामचुहा *ramchukka* (Patna and Gaya), a drinking-vessel.

रास *rās* (East Tirhut), a little vessel with a narrow neck, used for holding milk and similar purposes.

रिकाबी *rikābi*, a saucer.

रिखेबी *rikebi* = रेकाबी *rekābi*, *q.v.*

रेकाबी *rekābi* or (Patna and Shahabad) रकेबी *rakebi*, or (south-east) रिखेबी *rikebi*, a saucer.

लबना *labna* (Patna and Champaran), a water-pot in the shape of an ellipsoid.

लबनी *labni*, the vessel in the shape of an ellipsoid, in which palm-juice (ताड़ी *tāri*) is collected from the trees.

लाद *lād* = नाद *nād*, *q.v.*

समकी *sanki* (South Bhagalpur and Gaya), a saucer used by Musalmāns.

समक *sanhak*, समककी *sanhaki*, a broad flat dish used by Musalmāns for eating boiled rice.

सरबी *sarbi* (South Bhagalpur), a cup for distributing pulse, &c., from the cooking-pot. Used at marriages.

सुराही *surāhi*,—see सोराही *sorāhi*.

सेफाली *sephāli* (Patna, Gaya, and Shahabad), a flat earthen dish.

सेरहा *serha*, a vessel for drinking spirits.

सोराही *sorāhi* (north of Ganges) or सुराही *surāhi* (south of it), a water-vessel with a long narrow neck.

हँडिया *hanriya*, diminutive of हँड़ी *hānri*, *q.v.*

हँडोला *hanrola*, diminutive of हँड़ी *hānri*, *q.v.*

हाथौना *hathauna*, a vessel for collecting date-juice, larger than a लबनी *labni*, used when the juice (ताड़ी *tāri*) flows freely.

हँड़ी *hānri* or हँडिया *hanriya* (small) or हँडोला *hanrola* (small), a vessel for cooking or holding milk, tyre, &c.

CHAPTER X.—WOODEN VESSELS.

714. The कठौत *kathaut* or कठौती *kathauti* is a large wooden dish for kneading flour. It is also called कठरा *kathra* south of the Ganges and to the west, तगारी *tagāri* in Tirhut and Champāran. डगरा *dagra* in Champāran and Gaya is a large flat dish made of wood. The उलदी *uldi* in the west, कठुली *kathuli* in Shahabad and South-East Tirhut, कठोली *katholi* in North-East and South-West Tirhut, and कठली *kathli* or अर्धिया *arhiya* in Shahabad, is a small wooden dish for scraps. In Patna, Gaya, and the south-east it is पैला *paila*.

715. The कस्कौल *kaskaul* (Patna), किस्ता *kista* (Gaya and the south-east), and कमचल *kamwandal* (generally), is a wooden cup carried by mendicants. In the north-west नरियारी *nariyari* is an oval one. तूमा *tuma*, तुम्मा *tumma*, or तुम्बा *tumba*, is the mendicant's gourd.

716. सेवती *sewti* or (North-East Tirhut) सौथी *sauthi* is a wooden platter used by sailors.

717. डोकनी *dokni* (Sāran and Champāran) and डकना *dhakna* (North Tirhut) are small wooden dishes.

718. The डोई *doi* or (south of the Ganges) डोया *doa*, or (South-West Shahabad) डोकी *doki* or (south-east) डोउया *doüä*, is a wooden ladle used by Muhammadans in cooking pulse. The corresponding word amongst Hindus is, in North-East Tirhut, दाबि *dābi*, and in Champāran दाबा *dāba*. घटना *ghatna* in Gaya is a machine for stirring pottage as it is being cooked.

CHAPTER XI.—LEATHER VESSELS.

719. South of the Ganges the मलवा *malwa* is used for holding oil. In Champāran it is मलिया *maliya*. कुप्पा *kuppa* or कुप्पी *kuppi* is for holding oil or clarified butter (घ्यू *ghyu*). नदोई *nadoi* is used in Gaya for the same purpose. In North-East Tirhut धोकड़ा *dhokra* is a sack used for the same purpose, as in the proverb गूड़क चोट धोकड़ें पुरु जान *gūrak chot dhokreñ punu jān*,—it's only the vessel that knows the pain (or weight) of the molasses, *i.e.*, only he who suffers, knows the pain. गेहा *gelha* is a similar smaller vessel.

जेरहा *gelha* or (in South-East Tirhut) चमरुई *chamri* is also a vessel for carrying molasses.

720. मोट *mot* or मोटि *moti* is the large leather bucket for drawing water from a well. डोल *dol* is the smaller one. मसक *masak* is the leather water-skin borne by water-carriers. इसी कुप्पा *dasti kuppa* is the small leather bag used by torch-bearers (मसालची *masālchi*) for carrying oil.

CHAPTER XII.—LEAF-PLATTERS.

721. The दोगा *dona* is a small round leaf-platter. In Patna, Gaya, and the north-west it is also called खोना *khona*, and in Shahabad खदोगा *khadona*. The पत्ता *pattal* is a broader and flatter kind, and is also used as a kind of basket at Hindu marriages when a number of guests are to be fed. It is also called पतरौ *patri* in Shahabad, पत्ता *patta* in South Bhagalpur, and पतरौरी *patrauri* or पन्मारा *panmāra* in Champāran and North-West Tirhut.

CHAPTER XIII.—STANDS FOR VESSELS.

722. These are made of mud or brick, and known as बिरन्दिही *ghirsirhi* in the north-west, east, and Patna, बिसिरी *ghisiri* in Sāran, बिरन्दिही *ghirsindi* in Patna and Gaya, बिरन्दिर *ghirsir* in Patna and Shahabad, and बिरन्दिही *ghirsandi* in South Munger. Other names are घैलसारी *ghailsari* in South-East Tirhut, गलसारी *ghalsari* in South Bhagalpur, गलथारी *ghalthari* in North-West Tirhut, गहौंची *gharaunchi* (South-West Shahabad), and चौतरा *chautra* or ओटा *ota* (Champāran).

SUBDIVISION III.

CLOTHES AND ORNAMENTS, &c.

CHAPTER I.—CLOTHES.

723. The general terms are कपड़ा *kapra*, चीर *chir*, and लूगा *lūga*. The last has local variants, नूगा *nūga* (South-East Tirhut) and लुगा *lugā*, नुंगा *nunga*, or नूंगा *nūnga* south of the Ganges. Other names, current principally to the west, are पहरावा *pahrāwa*, बहार *bastar*, or



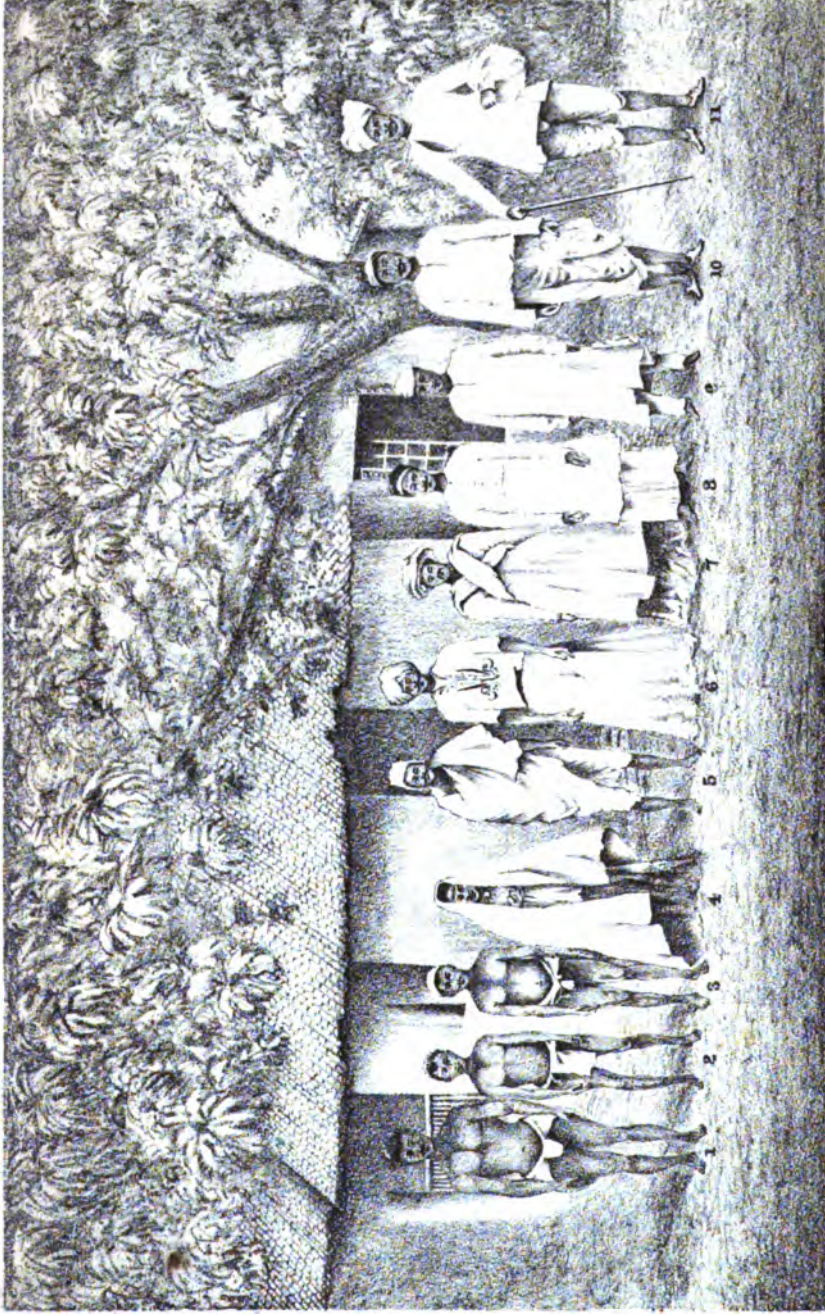

1. *Chit.*
2. *Kopin.*
3. *Topi bhagwa.*
4. *Tubband kamdhara.*
5. *Kanjappa, dumar, dhoti.*
6. *Muretha, nimsatin, kulidar, pajama.*
7. *Puyri, chudidar, jama, ekattedar pajama.*
8. *Chaugoshiya topi, achkur, ekattedar pajama.*
9. *Chaugoshiya topi, aba, chwidar pajama.*
10. *Bubhnuu topi, mirjai, dhoti.*
11. *Muretha, dhoti, kurla, chudidar, dhoti.*

A Bihar Fashion Plate
CLOTHES WORN.

कपड़ा कप्रा *kapra latta*. A suit of clothes is called पाँचो टुक कपड़ा *pāncho tūk kapra*, and consists of a turban, loin-cloth, jacket, sheet, and bathing-cloth.

724. Amongst men's clothes are—

The turban.—पाग *pāg*, पागिया *pagiya*, पगन्दी or पगरी *pagri* is a piece of cloth woven for the purpose. The inner portion of the made-up turban (बूत के पगन्दी *būt ke pagri*) worn by the more respectable people is called पेंटा *phenta*. सुरेठा *muretha* is a piece of ordinary cloth, or even a garment, such as the गमन्हा *gamchha*, चद्दर *chaddar*, or दोपट्टा *dopatta*, worn round the head. चीरा *chira* is a checked turban. A piece of cloth wound under the chin and over the head is ढाढा *dhāṭha*; also गलौधी *galaudhi* in Patna and East Tirhut, गलमोच्चा *galmochha* in Tirhut and to the east and (optionally) south of the Ganges, and गलजिन *galjin* in North-West Tirhut and Gaya.

725. The cap is टोपी *topi* or ताखी *tākhi*. The round cap covering the ears worn by Brāhmans is मुन्दा *munda* in Sāran and North Tirhut, कासीवाक *kaswāl* in South Tirhut, ताज *tāj* in North-East Tirhut, Patna, and the west, and बभनौ *babhnau* in Shahabad and South-East Tirhut. दोपट्टिया *dopaliya* is a long cap made of two pieces, and the चरन्पट्टिया *charpaliya* or चौगोशिया *chaugoshiya* is round and made of four pieces. The कन्टोप *kantop*, कन्जप्पा *kanjhappa* (both of these also to the west and in Patna), and कान्दार टोपी *kāndār topi* (all north of the Ganges), is a piece of cloth worn loose over the head. South of the Ganges it is कुल्ही *kulhi* or कन्जप्पो *kanjhappo* (Patna and South Munger), कन्जप्पी *kanjhappi* (Gaya), and कन्जोपा *kanjhopa* (South Bhagalpur). कुल्हिया *kulhiya* in Gaya is a boy's cap. घोंघा *ghongha* in Gaya is a wide umbrella-shaped hat of *tāl* leaves, worn in rainy weather.

726. *The loin-cloth.*—This is धोती *dhoti*. North of the Ganges and in Shahabad it is also called मरदानी *mardāni*, and in Shahabad, Patna, and Gaya लुङ्गी *lungi*. The small loin-cloth is लँगोटा *langota* or लँगोटी *langoti*; also in Patna लङ्गोट *langot*. Other names are कोपिन *kopin*, in Champāran कोपीन *kopin*, and in the south-east नँगोट *nangot* or नँगोटा *nangota*. कप्पा *kappa* (east) is a small cloth worn round the waist by the poor. The भगवा *bhagwa*, or in Sāran भगई *bhagai* and North-East Tirhut धरिया *dhariya*, is a small *dhoti* principally* worn by

* It is not always worn by boys. Compare the proverb चोरक भगवा दाही *chorak bhagwa dāhi*,—burn a thief's loin-cloth, i.e., disgrace him as much as possible.

boys. The बिसुन्नी *bisti*, or in Gaya बिहूनी *bichhuti*, is the scrap worn by poor boys. The small tight cloth worn by wrestlers, and also the usual cloth tightened up to allow of free play of the limbs in violent exercise, is काचा *kāchha* or कच्छा *kachchha*. Other names are चरन्ना *charna* (Champāran, Patna, Gaya, and the east), चिट *chit* (Patna), समाली *samāli* (Gaya and the south-west), भरकच्छ or भड़कच्छ *bharkachh** (North-East Tirhut), and भड़काच *bharkāchh* (South-East Tirhut). तहमद् *tahmad*, or in Shahabad तहबन्द *tahband*, and in Champāran तची *tahi*, is a loin-cloth worn by Musalmān mendicants (*fakirs*). The tag of the loin-cloth tucked in behind is पिछुवा *pichhua* or पछुवा *pachhua* to the west. To the east it is डेंका *dhenka* or डेंकुवा *dhenkua*. The loose end which hangs down in front is खूंट *khūnt*, साँची *sānchi* (North Tirhut), and पुच *puchchh* (South-East Tirhut). In South Bhagalpur it is कोंची *konchi*. The knot in the loin-cloth for holding money, &c., is फाँड़ *phānr*, फाँड़ा *phānra*, or फण्डा *phanda*. They are also called चेंड *chent* or टेंड *tent* towards the west, and पेंच *pench* in North-West Tirhut. Other local names are हरिड़ा *harira* (North-East Tirhut), ऐरहा *airha* or मूरी *mūri* (both South-East Tirhut).

727. *The drawers.*—These are पैजामा *paijāma*, also south of the Ganges इजार *ijār* and खिस्कट *khiskat* (apparently a corruption of the Persian خشک *khishtak*). In South Bhagalpur they are also called तमान *tamān*, and in North-West Tirhut सुरवाल *surwāl* (a corruption of the Persian شلوار *shalwār*). According to the Kānūni Islām, the *ijār* and *surwāl* are not so wide as the *paijāma*. Tight drawers are चुड़िदार *churidār*, also चुस्ट *chust* to the west and in South Bhagalpur. If loose at the ankles, they are मोहरिदार *mohridār*; also खल्लेदार *khalledār* in Patna and to the west, बरकाबर *barkābar* in Gaya, and पेंचेदार *painchedār* elsewhere. If loose, with pieces let in along the thigh, they are कलिदार *kalidār*. जंघिया *janghiya* are tight-fitting short drawers, such as those worn by wrestlers.

728. *The jacket.*—This is मिरजै *mirjai* and also खुटिया अंगरन्ना *khutiya angarkha*.

729. *The coat.*—This is अङ्गा *anga*, अंगरन्ना *angarkha*, or चपकन *chapkan*. Those worn by Hindus open on the right breast, and those by Musalmāns on the left. It is tied at the neck by a string, चुडी

* Compare Manbodh's Haribans, which is a Maithil poem. कदमक तरु चदि भड़कच्छ कारि *kadamak taru charhi bharkachh māri*,—(Krishna) mounted the *kadam*-tree and tightened his loin-cloth.

ghundi or *घुंडी* *ghūnri*, and also to the east and south *हुण्डी* *bhundi* or *हूंडी* *bhūnri*, and in South Bhagalpur *हुण्डो* *bhundo*, which runs in a hem, *तुकमा* *tukma*, or (in Patna and Gaya) *गाली* *gāli*. The *अचकन* *achkan* is a long loose coat buttoning right down the front. The *काबा* *kaba* or (south of the Ganges) *कबा* *kaba* is an outer coat open at the chest and sleeves. The *निमास्तीन* *nimāstin* (also called *नीमा* *nima* south of the Ganges) is a jacket the sleeves of which reach only to the elbows, while the *शलुका* *shaluka* and *सदरी* *sadari* leave the arms bare.

730. *The sheet.*—This is *चदर* *chaddar* or *चादर* *chādar*. This is of various kinds, viz. the *दोहर* *dohar* is a doubled sheet hemmed all round. The *गिरेफ* *gileph*, *सलगा* *salga*, or *कोल* *khol*, is similar, but is not hemmed all round, and is generally made of coarse cloth (*मोटिया* *motiya*). The *एकपट्टा* *ekpatta* or *एकलार* *eklāi* is a sheet made of one breadth of cloth. *देरपट्टा* *derhpatta* or *देरपट्टी* *derhpatti* is a sheet whose whole breadth is made up by sewing together two cloths, of which the breadth of one is half that of the other. The *दोपट्टा* *dopta* or *दोपट्टा* *dopatta* is a sheet whose breadth is made up by sewing together two cloths of equal breadth. *उतरी* *utri* to the east is an outer garment. To the west it is used (a) for the string tied round a corpse's neck, and (b) for the mourning garments worn for ten days by the *करना* *karta*, or person who lights the funeral pyre.

731. *The stuffed quilt.*—These have various names, according to the amount of cotton-wool in them, viz. *लेहाफ* *lehāph* (five or six *seers*); *राजा* *rajāi*, *नेहाली* *nehāli*, or (South Bhagalpur) *लेहाली* *lehāli*, all of which hold from one to three *seers*; and the *दोलाई* *dolāi*, *सीरक* *sirak*, or (in South Bhagalpur) *तुरा* *turāi* or *सीरग* *sirag*, which contain less than half a *seer*. The stuffing of the quilt is *भरना* *bharna* or (to the south) *भराव* *bharāv* or *भराना* *bharāna*. Bits of old cotton padding in a quilt are *अंगा* *anga* north of the Ganges. A similar quilt made of patchwork is *गुदरा* *gudra* or *गुदरी* *gudri*. When made of rags it is *खेंदरा* *khendhra*; also optionally in Tirhut, Patna, Gaya, and the east *गेंदरा* *gendra*, and in Shahabad *लेंदरा* *lendra* or *लेदरा* *ledra*. See also § 637.

732. *The long coat worn by well-to-do people* is *आबा* *āba*. The kind of court dress consisting principally of flounced petticoats is *जामा* *jama*.

733. *The bathing-cloth*, worn round the loins while bathing and used for drying the body afterwards, is named differently by Hindus

and Musalmāns. The former call it **अंगोचा** *angauchha* or **गमचहा** *gamchha*, a local variant being **अंगोचा** *angochha* to the west. A smaller kind, or *handkerchief*, is **अंगोची** *angauchhi*, **गमचही** *gamchhi*, **साफी** *sāphi*, **तौनी** *tauni* (East Tirhut), or **तिउनी** *tiuni* (North-West Tirhut). The Muhammadans call the bathing-cloth **लुङ्गी** *lungi* or **लुंगी** *lungi*. The **हजुरिया** *hajuriya* is a similar bathing-cloth worn by Hindu mendicants (**बैरागी** *bairāgi*).

734. *The purse.*—This is **थैला** *thaila*, **थैली** *thaili*, **बट्टु** *battu*, **बट्टा** *batua*, or **बट्टे** *batui*. The **जोरा** *jhora* is a larger bag. In Gaya and to the west it is also **घोगी** *ghoghi* or **धोकरी** *dhokri*. The **बगुली** *baguli* or **तिलदानी** *tildāni* is a tailor's housewife. **लोखर** *lokhar* is the case in which a barber carries his razors, &c. The last is also called **किस्मत** *kismat* north of the Ganges and **किसबत** *kisbat* south of it. The money-belt is **डोंडा** *donra* or **डोंड्या** *donrha*.

735. *The shoes.*—These are **जोड़ा** *jora*, **जूता** *jūta* (or **जुता** *jutta*), **जूती** *juti*, or **पनही** *panahi*. **जेरपा** *jerpāi*, **खरपा** *kharpa*, or (south-east) **चटका** *chatka*, are usually the shoes worn by women. The wooden bathing-patten with a peg to go between the toes is **खराण** *kharān*, **खराण** *kharān*, or **खराण** *kharān* (also to the east **खराण** *kharām* or **खराणी** *kharāni*) or **चपटा** *chapta*, and the clog held on the feet with strings or straps is **बाधा** *bādha* or **बद्धा** *badha*. In Saran and South-West Shahabad **लतरी** *latri* are old shoes.

736. The Brahmanical cord is **जनेव** *janev*, **जनेव** *janeu*, or (to the south-east) **जनेव्या** *janeüa*. The knots in the cord are **परवर** *parwar* or **परवल** *parwal*. In Tirhut and South Bhagalpur they are also **परवल** *parbal*. The **सत सिखा** *sāt sikha* is the projecting part beyond the knot. The length of the cord is measured by handbreadths (**चौथा** *chāua*). A Brāhman's cord is 96 handbreadths long, and so also a Rajpūt's, but the knots are different.

737. *The blanket.*—This is **कम्मर** *kammar*, **कम्मल** *kammal*, or **कम्मरा** *kamra*. In South-West Shahabad it is also **राल** *rāl*. A small blanket is **कम्मरी** *kamri* or **कम्मरिया** *kamariya*. In Champaran and the south-east **धूस** *dhūs* or **धुसा** *dhussa* is a thick kind of blanket. **पच्छती** *pachhatthi* is a large blanket five cubits long, and **छहती** *chhahattha* or **छहती** *chha-hatthi* is six cubits long. **घोगी** *ghogi* is a peculiar way of tying a blanket over the head to save the wearer from rain. In South-West Shahabad it is also called **घोंगी** *ghonghi*, and in Patna and North-East Tirhut **बुकी** *bukki*. The blanket forms the subject of many proverbs: thus **घोंगी** *ghōngī*

शीं कम्मर मारि *jyōñ bhije, tyōñ kammar bhāri*,—the more a blanket is allowed to become moist, the heavier it gets, *i.e.*, delays are dangerous.

738. A patch on the clothes is *पेवन्* *pewan*, local variants being *पेवन्* *pewand* south of the Ganges and *पौना* *pauna* in South-West Shahabad. It is also called *पाटी* *pāṭī* or *पटिया* *patiya* to the east. Another name is *चेफन्दी* *chephri* in North-East Tirhut.

739. When cloth is doubled, the *outer piece* is *अबन्ना* *abra* or (in South Bhagalpur) *पल्ला* *palla*, and the *lining* *अस्तर* *astar* or (in Champāran and North Tirhut) *ताही* *tahī*.

740. Among women's clothes are—

The sheet.—This is *सारी* or *साड़ी* *sāri* generally, with a variant *सरिया* *sariya* to the east. To the west and in Patna and Gaya it is also called *खिलुआ* *khilua*. It is also called *लुगा* *luga*, with, in East Tirhut, a variant, *नूगा* *nūga*. In South Bhagalpur it is called *बरन्तही* *barhatthi* (when 12 cubits long), and in South Munger *खान्दी* *khāndī* or *खन्दा* *khanda*. An old torn sheet is *लुगरी* *lugri*, as in the proverb *नई धोबिनियाँ बारसि, लुगरिदे साबुन छारसि* *nai dhobniyāñ āilī lugriye sābun lāilī*,—the new washerwoman has come and applied soap even when washing rags, *i.e.*, a new broom sweeps clean. A proverb of similar import is *नया नोकर खरगोस पकड़न्तारे, नया नोकर खरगोस* *naya nokar khargos pakartāre*,—a new servant will catch a hare, or, as they say in Ireland, a sharp fellow won't let a hare catch him. The smaller sheet worn by poorer women is *जानाही* *janāhī* *धोती* *dhōṭī* or *लुगरी* *lugri*. Over the *साड़ी* *sāri* is worn another sheet, called *चद्दर* *chaddar* or *चाद्दर* *chādar*, or (in Gaya and South Munger) *पिछौरा* *pichhaura*. This may be *दोपन्ना* *dopta* or *दोपद्दा* *dopatla*, as in the case of a man's sheet. The small sheet worn by little girls is *परन्तहा* *parkhanda* to the west and in South Bhagalpur and Gaya *बरन्की* *barkī* in Patna and the south-west. It is *फलिआ* *phaliya* in Sāran and North-West Tirhut, *गान्ती* *gāntī* in South Bhagalpur, and *सरिया* *phariya* in South-West Shahabad. We also find *खेरुकी* *kheruki* or *खरुकी* *kharuki*, *खेरुका* *kheruka* or *खरुका* *kharuka*, north of the Ganges, and *पुतन्की* *puthī* in South Tirhut, Patna, and South Munger.

741. The hem of the sheet is generally *आँचर* *ānchar*, and also *आँचरा* *ānchara* or *अचरा* *achra*. This is also the part which covers the bosom. The first of these words is the nominative, and the others are more properly used with postpositions. Thus *ई आँचर बड़ नीमन वा* *ī ānchar bar niman bā*,—this border is very beautiful; but *अचरा में वाद्*

देवों *achra men bānh delin*,—I tied it up in the hem of my garment. The end of the sheet gathered up and tied in front is डडुवि *phuphuti*, डडुनी *phuphuni*, or डडुनी *phuphundi* to the west, and कोंचा *koncha* or कोंची *konchi* to the east. The pocket in front formed by loosening the part tied round the waist is खौरचा *khoinchha*, and in the extreme south-east खोएचा *khoechha* or खोंचा *khonchha*, as in the proverb बुदबब कनेचाँ केँ नौ बाना खौरचा *burbak kaneāñ keñ nau āna khoinchha*,—it's a fool of a bride that only gets nine anās in her pocket (for wedding presents). The loose fold on the left side is गोजनौटा *gojhnauta*. In the south-west it is पिछौरा *pichhaura*. When a woman is modest and meets a strange man, she draws her sheet or veil (see below) before her face. This action is called बोट *ghoghat*, or in Gaya घुग्घा *ghugggha*, in South Bhagalpur बोबो *ghogho*, and to the north-west घुघ *ghūgh* or बोघ *ghogh*; and when a woman wishes to be extra modest, she pulls a great deal over her face. She is then called बड़ बोट *bar ghoghat*.*

742. चसदार *chasdar* is a dyed cloth with a double-hemmed border worn by women in Shahābad. In the same district मसार्हु *masārhu* is a dyed cloth used by females of the lower orders, and भिमकी *jhimki* is a cloth printed with flower patterns. ककरेजा *kakreja* is a purple, and सलू *sālu* a red cloth, much used everywhere.

743. *The petticoat*.—This is generally लँघना *lanhga*. A looser kind is घँघरा *ghanghra* in Gaya and to the east, घँघर *ghanghar* in the south-east, and कँघर *ghānghar* in Shahābad. The घँघरी *ghanghri* is a girl's petticoat. काचा *kāchha* is a mode of tying it under the leg. The waist-band through which the string is run is नेपा *nepha*, and the string itself is रजार बन्ध *ijār band*, or in the case of a bride or bridegroom नारा *nāra*. The hem is also called कमरनौर *kamartoi*.

744. *The bodice*.—This, if it reaches to the waist, is कुरन्ता *kurta*, झूला *jhūla*, or in North-East Tirhut कसनि *kasani*. If it is short, only covering the breasts, it is अंगिया *angiya* or चोली *choli*. A similar short bodice, worn chiefly by prostitutes, is called महरम *mahram*. This last in North-East Tirhut is called चोली *choli*.

745. *The veil* or cloth worn over the head is खोइनी *orhni*. When a veil or a sheet (चादर *chādar*) has a dyed border, it is called घुग्घी

* As in Manbodh's Haribans, where the wife of Akrūr, although very modest, still wanted to look at Krishna when he came into the house, बड़ बोट घुघ तकबो चादर *bar ghoghat punu takalo chāhia*.

chunri or चूंदरी *chundri*, and also in Saran जित्की *jhtki*. The border is called in North-East Tirhut पाहि *parhi* or पडिया *parhiya*.

746. The drawers are पैजामा *paijama* or (in North-West Tirhut) सुरवाल *surwal*.

747. *Toilet requisites.*—The antimony put on the edges of the lower eyelids is सुरमा *surma*, and the lampblack applied to the eyeball is काजर *kajar*, as in the proverb ठाँव गुन काजर, कुठाँव गुन कारिख *thamwo gun kajar, kuthamwo gun karikh*,—in the right place it is collyrium, and in the wrong place, soot. Lampblack is kept in a box called काजराटा *kajrauta* or काजराटी *kajrauti*. The coarser red lead put on the forehead and on the parting of the hair is सेंदुर *sendur* or सेहुर *senur*. The finer kind placed between the eyebrows is इंगुर *ingur*. The silver spots put on the forehead are called तिकुली *tikuli*, and the round silver spot between the eyebrows is बिन्दी *bindi*. The small silver or gold spots surrounding this are, in North-East Tirhut, बेनी *beni* or बेनिया *beniya*. The comb is ककड़ा *kakha*, ककड़ी *kakhi*, or काँगी *kangahi*. It is also ककवा *kakva* in Patna, Gaya, and South Bhagalpur. The लिखगहनी *likhgahni* is a kind of comb used in Gaya. The hair-brush is ठकरी or थकरी *thakri*. To the east जरनी *jharni* is a kind of brush made of the stem of a cocoonut leaf. A tooth-brush is दतुवान *datuan*. It is made by biting one end of a sprig of wood till the fibres form a brush. Hindus use a fresh one every day, but Musalmans keep theirs for a fortnight at a time.

748. *Washing of clothes.*—See §§ 389 and ff.

In *making clothes*, the following terms are used by the tailor or दरजी *darji*:—

पसल *paslj* is running, तुरपाँ *turpai* hemming or felling, उरमा *urma* is top-sewing, लङ्गड़ *langar* tacking or basting, चून *chun* gathering. बखिया *bakhiya* or बखेया *bakhea* is stitching, चाँप बखिया *champa bakhiya* is long stitching, and डोरी दे के बखिया *dori de ke bakhiya* stitching-in piping-cord. जावा *jawa* is a long stitch and a short stitch alternately, and काँटा फोड़ी बखिया *kanta phori pakhiya* is a kind of stitching for which there is no English name. सुल्तान लोड़ी *sultan lorhi* is a mantua-maker's hem, सारजी *saryi* is herring-boning, and जाळी *jali* a kind of herring-boning for joining two cloths but not bringing their edges together. दरज *daraj* is a run-and-felled seam. When it is narrow, it is called गोल *gol*; when wide, इमलपत्ती *imalpatti*; and when very wide, चौरा *chaura*. There are false hems of various kinds. When

the edges of the two pieces meet evenly, it is called पही *patti*; when the edge of the added piece extends beyond the edge of the main piece, the false hem is called, if it is narrow, मगजी *magji*, which properly means the overlapping portion. If it is wide, it is called सजाफ *sanjāph*. When the overlapping portion is very wide, the false hem is called लखनवाला सजाफ *lakhnawāla sanjāph*, or in Shahabad लखनौवाला सजाफ *lakhnauī sanjāph*. काज *kāj* is button-hole stitch, and हूल *hūl* eyelet-holing.

749. सिहारा *silāra* is a kind of embroidery. Two thicknesses of muslin are sewn together. The under one has holes cut out in it which are embroidered, and are visible through the upper one. It is used as an ornamental border. बेल *bel* is similar to सिहारा *silāra*, except that patterns of various leaves, &c., and not holes, are cut in the lower muslin. सिंघारा *singhāra* is an embroidered scalloped or vandyked edge. सोराही *sorāhi* is a piece of calico cut into an ornamental shape and *appliquéd* on to the shoulder of a coat. उल्हा मुन्धा *ulta mundha* is binding an armhole with piping-cord. कन्था *kantha* is a rounded collar sewn in front of the coat. A sleeve is said to be चुड़िदार *churidār* when it is gored to fit tight at the wrist. A gore is घोर *ghor*. There is no Bihāri equivalent for "dart," "pleat," or "tuck."

CHAPTER II.—CARPETS AND MATS.

750. A floor-cloth is काहीन *kāhīn* south of the Ganges, north of the Ganges जाजिम *jājim*, or (to the west) फरस *pharas*. A carpet is दर्री *dari*, or when larger सतराजी *satranjī*. A गलेचा *galācha* or गलीचा *galīcha* is a thread mat. चही *chatti* in South Bhagalpur is a canvass mat, and चाही *chāhi* in Gaya is a coarse kind of mat made of bamboo slips tied together.

751. चतर *chatāi* or चटेनी *chataīni* is a mat made of various reeds or bamboo slips. A गोन्दरी *gonri* or गोंदरी *gondri* is made of the *gond* reed. In Patna, Gaya, and the south-west सफ *saph* is a long *gond* mat used when a number of people are assembled at a marriage, &c. In the north-west it is धादा *dhārha*, in South-East Tirhut चटान *chatān*, and in North-West Tirhut बरहत्था *barhattha*. A तराय *tarāy* to the east is made of palm leaves, and a तरई *tarāi* in Champaran of reeds. सितलपाटी *sitalpāti* is a fine mat for sleeping on in the hot weather. When a number of Musalmāns say prayers together on one carpet, it is called जाजिमाज *jānimāj*, or in South Munger जायनेमाज *jāyнемāj*; and when on a mat, it is called सफ *saph*.

CHAPTER III.—JEWELRY.

752. The following are some of the varieties of jewelry commonly worn :—

a.—Worn by Men and Boys.

753. *On the ears.*—बाही *bāhi* or (in Shahabad) बारी *bāri*. This is a ring. Also the कानौसी *kanausi* (Patna and Gaya, where it is worn by Hindus only). Other ear pendants are मोती *moti*, गोकुला *gokhula* (and to the west also गोरखुल *gorkhul*) (an ornamented ring), कुण्डल *kundal* (a large ring), लोर *lor* (worn principally by Goalās), and कनवाला *kanbāla*. सोना *sona* is a plain ear pendent, and अन्ती *anti* is a plain stud fixed in the lobe of the ear. फिरकी *phirki* is a double gold ring.

754. *On the arms.*—The बाँक *bānk* and चौकठा *chauktha* are worn on the right upper arm. So also the बिजावठ *bijawath* or बिजौठा *bijautha*, which is, however, more properly a female ornament. The अनन्त *anant* and ताबीज *tāwij* are various kinds of amulets.

755. *On the neck.*—The माला *māla* is the bead necklace. The उदर्राह *udrāchh* is one made of the seeds of the वद्राह *rudrāchh* (*Eleo-carpus ganitrus*). The कन्था *kantha* is a necklace with gold and silver ornaments or sacred relics attached to it. The मुंगवा *mungwa* is a coral (मूंगा *mūnga*) necklace, and the मोहर माला *mohar māla* or मोहन माला *mohan māla* is a long necklace of gold *mohars* and coral. The गोप *gop* is made of twisted gold wire, and it is also called घुन्सी *ghunsi* in Champāran, North Tirhut, and South Munger. The सिकरी *sikri* is a long chain going round the neck.

756. *On the fingers.*—This is अंगुठी *anguthi*, ऐंठुआ *ainthua* (Gaya), or औंठी *aunthi*. The गोरख धन्धारी *gorakh dhanhāri* or गोरख धँधारी *gorakh dhandhāri* is a puzzle-ring which takes to pieces and is difficult to put together again. मुन्दरी *mundri* is a ring worn on the right little finger. गोल *gol* (Shahabad) and फेरुआ *pherua* (Patna and Gaya) are kinds of rings.

757. *On the wrist.*—These are बाला *bāla* or (Patna and Gaya) बलेवा *balea*, पञ्चौ *pahunchi*, and also (south of the Ganges) पञ्चारी *pahunchāri*, कड़ा *kara* (south of the Ganges), बेरा *bera* in Gaya and to the west, जिग्गा *jigga* in Sāran, मडिया *mathiya* in South Bhagalpur, and तोड़ा *tora* in South-West Tirhut. These are worn principally by boys. तैन्ती *tainti* is a kind of amulet in South Munger, Gaya, and Shahabad.

758. *On the waist.*—The chain hung round the waist is *करन्धन* *kardhan* or *करन्धनी* *kardhani*; also *करन्धरा* *harhara* in the east. A kind of belt is *जौंगरा*, and of this *जावा* *jāwa* or *जवारी* *jawāri*, *जंगड़ा* *langra* and *जरी* *jai*, are portions of the clasp.

759. *On the ankles.*—A boy's anklet is *गोड़ाँच* *gorānc*, *गोड़ाँच* *gorānc*, or *करा* *kara*. South of the Ganges we also meet *गोड़रा* *gorha*, *घुंघुर* *ghunghur*, or *घुंघरू* *ghunghru* (fitted with bells, used also in Tirhut), and *चौरासी* *chaurāsi* (when it carries 84 beads).

760. *On the toes.*—*अंगुठा* *angutha* is a toe-ring.

b.—Worn by Women.

761. *Ornaments for the head.*—The ornamented hair-pin is *चौंटी* *chonti*.

762. *Ornaments for the forehead.*—The *मंगळीका* *mangṭika* or *बननी* *banni* is an ornament tied in the centre of the forehead by three strings, one passing round each side and the other over the top of the head. They are fastened in the hair. Of this the ornament is called *चौकठा* *chaukṭha*, and the strings *सिकरी* *sikri*. The spangles or wafers gummed on to the forehead are *टिकुली* *tikulī*. Another name in South-West Tirhut is *सिधपूख* *siphāl* or *चाँद* *chānd*. In Shah-abad *सटिया* *satiya* is a wafer made of embossed paper and gummed on the forehead.

763. *Nose-ornaments.*—The nose-studs fastened on to the outside of one nostril is *चुकी* *chhuchchhi*, in South Bhagalpur *नकचन्दा* *nakchanda*, and in Patna and to the south-west *लौंग* *laung*. It is not an easy thing to steal, hence the proverb *काहवाँ लै सायद, चोरवाँ लै चहुचहि* *kaḥawai lai saiyad, chorawai lai chhuchchhi*,—by name he is a *saiyad*, but he can steal even a nose-stud. The ring passing through the outside side of the nostril is *नथ* *nath*. A smaller kind is *नथिया* *nathiya*, and that worn by girls *नथुनी* *nathuni*. The *बुलाक* *bulāk* or *बैसर* *besar* is a ring hung from the centre cartilage of the nose, and the *जुलनी* *julni* is a similar one worn by women of the *Rauniyār* caste. It swings backwards and forwards, and is ornamented with beads.*

* Nose-ornaments are peculiar to females. If a mother loses a first-born son she endeavours to persuade the demon who kills children that any future boys born are only girls, and hence not worth killing. To do this, she often makes the boy wear nose-ornaments, and calls him by some nickname, as *Bulāki* (wearer of a nose-ring), &c. There are other similar customs, such as giving opprobrious names to such sons who are born after the death of a first born, which it would take too much space to mention here.

764. *Ear-ornaments.*—Ear-studs fastened to the lobe of the ear are करनफूल *karanphul* or कनफूल *kanphul* and खोटडा *kholla*, or in East Tirhut खुटडा *khutla* or खुट्टी *khutti*, to the north-west खुट्टी *khutti*, and in Gaya and Shahabad खुट्टिया *khuttila*. The कनैली *kanaili* is a stud worn on the cartilage just where it leaves the head under the hair. Rings worn in the lobe of the ear are बाली *bali*, and those worn in the upper part of the cartilage उतरना *utarna*. Broad plates worn across the ear are पान *pāt*, पत्ता *patta*, and तरकी *tarki*. A smaller kind worn in Gaya is called गोहवा *gohwa*. Amongst pendants are the झूमक *jhūmak* or झुमक *jhummak*, which has two round pendants, and the जिमजिमिया *jhimjhimiya*, which are flat pendants. The मछरिया *machhariya* is a pendant shaped like a fish. In South Munger it is called मछलिया *machhaliya*. The लोर *lor* and कनौची *kanausi* form a set of ear-ornaments. The first are round plates with a square cut out of the inside, forming a kind of ring with a square inside. One of these is hung in the lobe of each ear. The latter is a ring. One is hung in the upper part of the cartilage of the right ear, and two in the upper part of the cartilage of the left ear. When a hole bored in the ear for an ornament is not in use, it may be filled up with a plug, called ठेक *thek*. When the ornaments worn are too heavy for the ear to carry without tearing, a chain is fastened round the ear so as to support the heavier ornaments. This is called सिकरी *sikri*. Other ornaments for the ear are बीड़ *bir* (Tirhut), कांप *kāmp*, and खुबिया *khubiya* in the south-east, and बिज्जी *bijji* in Patna and Gaya.

765. *Neck-ornaments.*—The चन्दर हार *chandar hār* is a long chain. A ताबीज *tāwij* is a similar one with an amulet attached. A set of three chains of various lengths is तेलरी *telri*, and also to the north-west तिलरी *tilri*, of five chains पचलरी *pachlari*, and of seven chains सतलरी *satlari*. The सिकरी *sikri* is a long chain, and the बद्धी *baddhi* is a long chain crossing the chest and going behind round the body. डमेल *humel* is a necklace fitted with bells. Bosses tied to the throat are चम्पा कली *champa kali*, जुगनु *jugnu*, and डोलना चौकी *dholna chauki*. The last is principally worn by the bride at a marriage, and is the first ornament put on before the marriage ceremony. The हंसुली *hansuli* is the solid necklet open in front which goes round the neck, and the तारक *tarak* is similar with pendants in front (worn by Musalmans). सुति *sūti* in North-East Tirhut is a kind of neck-ring. जवा गोगा *jawa gota*, गणसडका

galsatka, गरद्वानी *gardawāni*, and गरसी *garsi*, are various neck-ornaments used in Gaya. Other neck-ornaments are सिक्का (South-East Tirhut), कटेसर *katesar* (Champāran, Patna, and South Bhagalpur) or कटसर *katsar* (Tirhut and South Bhagalpur), and खम्बिया *khambhiya* (South Bhagalpur). हार *hār* or हरवा *harwa* is the general term for a necklace, and मोती माला *moti māla* is a pearl necklace, or one made with beads of the shape of pearls. लाली *lalri* and दरपन *darpan* are two ornaments worn on the breast in Gaya and South Bhagalpur. A हैकल *haikal*, or in Champāran हैलक *hailak*, is a long necklace composed of flat pieces, generally nine in number. When a man marries a second wife, an ornament is made representing the first wife, which the second wife wears. On the first occasion on which the second wife applies vermilion to her hair, she first puts some on the ornament before applying it to herself. This ornament is called सौतिन *sautin*, or in South Munger सौत *saut*.

766. *On the clothes.*—मनोरी *manori* are ornaments on the veil (सारी *sāri*), and अंचरी *anchri* on the hem of the sheet.

767. *Arm-ornaments.*—The following are worn by all classes. Highest up on the arm is the बाजू *bāju*, or बाजू बन्ध *bāju band*, which is a wide armband. Below it the बिजावठ *bijāwath*, बिजावठ *bijāeth*, or बिजौठा *bijautha*, which are five ornaments strung together; below that the बिरखी *birkhi*, which is smaller. Another name is बिरेंटी *birenti*. Below this comes the बैंक *bānk*, made of one piece. It is worn by Hindu women on the right arm, but by Musalmāns on both. Lowest down comes the बहुन्टा *babhuntā*, or to the west बहुन्टा *bahunta*, of five pieces and round. Arm-ornaments worn principally by Hindu women are अनन्त *anant* and तार *tār* or तरिया *tariya*. Similar to the last is also another ornament called बहुन्टा *bahunta*. सिकरी *sikri* is a chain worn on the upper part of the arm. खबिया *khabiya* is a kind of inverted cup hanging from the arm, and to which bells (बखवा *bachwa*) are attached; and घुन्डी *ghundi* little ball pendants hanging from the बाजू *bāju* or from an अनन्त *anant*. मुन्डी *mundhi* is a clasp. बरेखी *barekhi* in South-West Shahabad is an arm-ornament worn by women of the *Goāla* caste. Arm-ornaments worn principally by Musalmān women are,—on the upper arm, जौसन *jausan*, पान *pāt* (a flat piece tied on), and बहुन्टा *bajulla*, or in Sāran बिजुलि *bijuli* (worn immediately below the बाजू *bāju*); and on the forearm नौनगा *naunaga* or (in North-East Tirhut) नबग्रह *nabgrāh* of (nine stones). An

ornament worn on the back between the shoulders is called by Hindus पाव पान *pān* or पानवा *panwa*, and by Musalmāns बलमन्दार *balamtār*.

768. *Wrist-ornaments* are कंकणा *kankna*, कंकणी *kankni*, or कङ्गना *kangna*, or in Champāran ककना *kakna*, कचन्ना *kachra* (Gaya and the south-east), कतन्वा *katwa* (Gaya and the south-east), कतरी *katri*, कंसौठी *kansauthi* (Gaya and the south-east), कसिया *khasiya*, गोखन्वा *golwa* (Gaya and the south-east), चूर *chūr*, चूरी *chūri* (bangles), चन *chhan* or चन्द *chhand*, जरी *jarī*, जिग्गा *jigga*, टोड़ा *tōra*, तिनखन्दी *tinkhandi*, तिनन्गा *tinnaga*, तिसिचौठा *tisiauta* (Gaya and the south-east), नघुरी *naghuri* or निलिचुरी *nigihri*, or (in Gaya and the south-east) लघुरी *laghuri*, पचखन्दी *pachkhandi*, पखेला *pachhela* or पखेलिया *pachheliya*, पटरी *pātri*, पटन्वा *patwa*, पडचौ *pahunchi*, बँगुरी *banguri*, बड़न्वड़ा *bārbara*, or in Gaya बड़न्वर *barhar*, and in Champāran बेलचन्ना *belahra*, बाला *bala*, बाँहू *bānhu*, बीरा *bera*, बीखा *baunkha* (Gaya) (made of thread), मथिया *mathiya*, रुपौठी *rupauthi* (Gaya and the south-east), and लघुरी *laghuri* (see नघुरी *naghuri*). The समसेबन्द *samseband* is a keeper worn on the wrist to prevent the चूर *chūr* falling off.

769. *On the fingers.*—A ring is अंगुठी *anguthi*. A round solid ring is चह्ला *chhalla*. Other names are चीठी *aunthi* and ऐँठुषा *ainthua*. The गोरख चन्दारी *gorakh dhanhāri*, &c., is the same as that worn by men; so also the गोल *gol* and फेरुषा *pherua*. Other rings are तिनखलिया *tinchhaliya*, बखन्दी *bahloli*, अंगुष्ठाना *angustāna*, आरसी *ārsī* (which has a small mirror attached), मुँदरी *mundri*, लोभेरुषा *lobherua* (south-east), दरन्वाबादी *daryābādi* (*ib.*), पथरौठी *pathrauti* (*ib.*), चिरौगिया *chiraugiya* (*ib.*), अँधुषा *ankhua* (South Bhagalpur), मथानी *mathāni* (South-East Tirhut), बदामी *badāmi* (Tirhut), पोर *por* (*ib.*).

770. *On the waist.*—Waist-chains and bands are कदन्नी *kardhani*, कमरकद *kamarkas*, जब्बा *jhabba* or जभिया *jhabiya*, गठौरा *gathaura*, अँवरा *amwara*, कोचन्ब *koehban*, कमरजेब *kamarjeb*, सीपी *sipi*, जाफरी *jāphri*. The कोचन्ली *kothli* is a kind of pocket tied to the waist.

771. *On the feet.*—The ornament fitting on the ankle and covering and fitting on to the upper part of the foot is पाँव जेब *pānw jeb*. Like it are पावट *pāwat*, पैरी *pairi*, and पाँव सङ्कर *pānw sankar*. Over this comes the चर्रा *charra* or चह्ला *chhara*, a number of fine rings like the चूरी *chūri* on the arm; over this again the कड़ा *kara*; and at the top the चूर *chūr*. The पँजनी *painjni* are anklets with bells; so also किंकिनि *kinkini* and घुघुर *ghughuru* or घुँघुर *ghunghuru* in Gaya and North-East Tirhut.

772. *On the toes*—are *बँसुडा angutha* and *चहा chhalla*, which are rings. An ornament fitting over all the toes is *बिबिहा bichhiya*. In Gaya and the south-east *बहुरी baturi* is a toe-ring to which bells are fastened.

SUBDIVISION IV.

APPLIANCES USED IN WORSHIP.

773. The appliances of a Hindu temple are as follows:—The *बाँसुनी asni* is a sort of mat made of *kus* grass, wool, &c., for sitting on.

774. A spoon for throwing water on the *lingam* is known as *बाँसुनी achmani*; also *बचमुनी achmani* in South-West Shahabad, *बँसुनी anchauna* in Gaya, *बँसुनी anchauni* in Saran, and *बहुरी kalchi* in South Tirhut.

775. The *बहुरी jalpātar* is a vessel in which water is kept, and a smaller kind is *बँसुनी panchpātar*. The *बहुरी argha* is the saucer made of stone or metal in which the stone representing the *lingam* is placed. The *बँसुनी pinri* or *पिन्डी pindi* is the platform on which the *lingam* is placed. Other names are *सरार sarāi* (optional) in South-East Tirhut, *चौरा chaura* in South-West Shahabad, and *बहुरी jakhār* in the rest of that district.

776. *बहुरी ghanta* or *बहुरी ghari*, also south of the Ganges *बहुरी ghant*, are gongs or bells, and the *बिजन्धक bijghant* is a kind of gong with erect edges. *बहुरी ghanta* specially means a bell; *बँसुनी jhānjh* (small) or *बहुरी jhāl* (large) are the cymbals. *बहुरी sankh* is the conch.

777. The idol is *बहुरी marat*, also *बहुरी murti* in South Bhagalpur, and *बँसुनी pārkhat* optionally in South-East Tirhut. Its throne is *बँसुनी singāsan* or (in Patna and Gaya) *बँसुनी singhāsan*.

778. *बँसुनी horsa*, or in the south-east *बहुरी hursa*, is the round stone for grinding sandal-wood (*बहुरी chandan*). Another name is *बँसुनी chandrauta*. The vessel in which the ground sandal-wood is placed is *बहुरी katori*.

779. The censer is north of the Ganges *बहुरी dhupdān*, in Patna and Shahabad *बहुरी dhupdāni*, in Gaya *बहुरी dhupahra*, and in the south-east *बहुरी dhuperi*.

780. The *बहुरी dipdān*, *बहुरी dipdāni*, is the lampstand holding only one lamp or wick. One with four or five wicks is called *बहुरी arti*.

781. The सुमिरनी *sumirni* north of the Ganges and सुमरनी *sumarni* south of it is the rosary of nineteen beads. In Champaran and Gaya it is also सुमेर *sumer*. माळा *māla*, or in Saran and Tirhut कर्ममाळा *karmāla*, is a similar rosary of one hundred and eight beads. सुमरनी *sumarni*, &c., are also used for the large bead at the end of a माळा *māla*. A जापमाळा *jāpmāla* is a large rosary containing as many as a thousand beads. The अष्टोत्तरी *ashtotri* or अठोत्तरी *athotri* is a rosary which is kept in a small bag called जोरा *jhora*. Into this bag the worshipper puts his hand and turns the beads. The रुद्राक्ष *rudrākh* is a rosary used by worshippers of Shiva, as in the proverb बापक गरे मुंगरी, पूतक गरे रुद्राक्ष *bāpak gare mungri, pūtak gare rudrākh*,—the father has a club on his neck, and the son a rosary, *i.e.*, the father is a scoundrel and the son a devotee.

782. The तूमा *tāma*, तुम्मा *tumma*, or तुम्बा *tumba* is the hollow gourd carried by religious mendicants (बापू *sādhu* or जोगी *jogi*). It is also called कठारी *kathāri* or सागर *sāgar* in Saran and Tirhut. The तुमरी *tumri* is a small gourd. The कमण्डल *kamandal* is a similar vessel used for drawing water in a temple. A दण्ड कमण्डल *dand kamandal* is a similar vessel made of metal (brass, copper, gold, &c.)

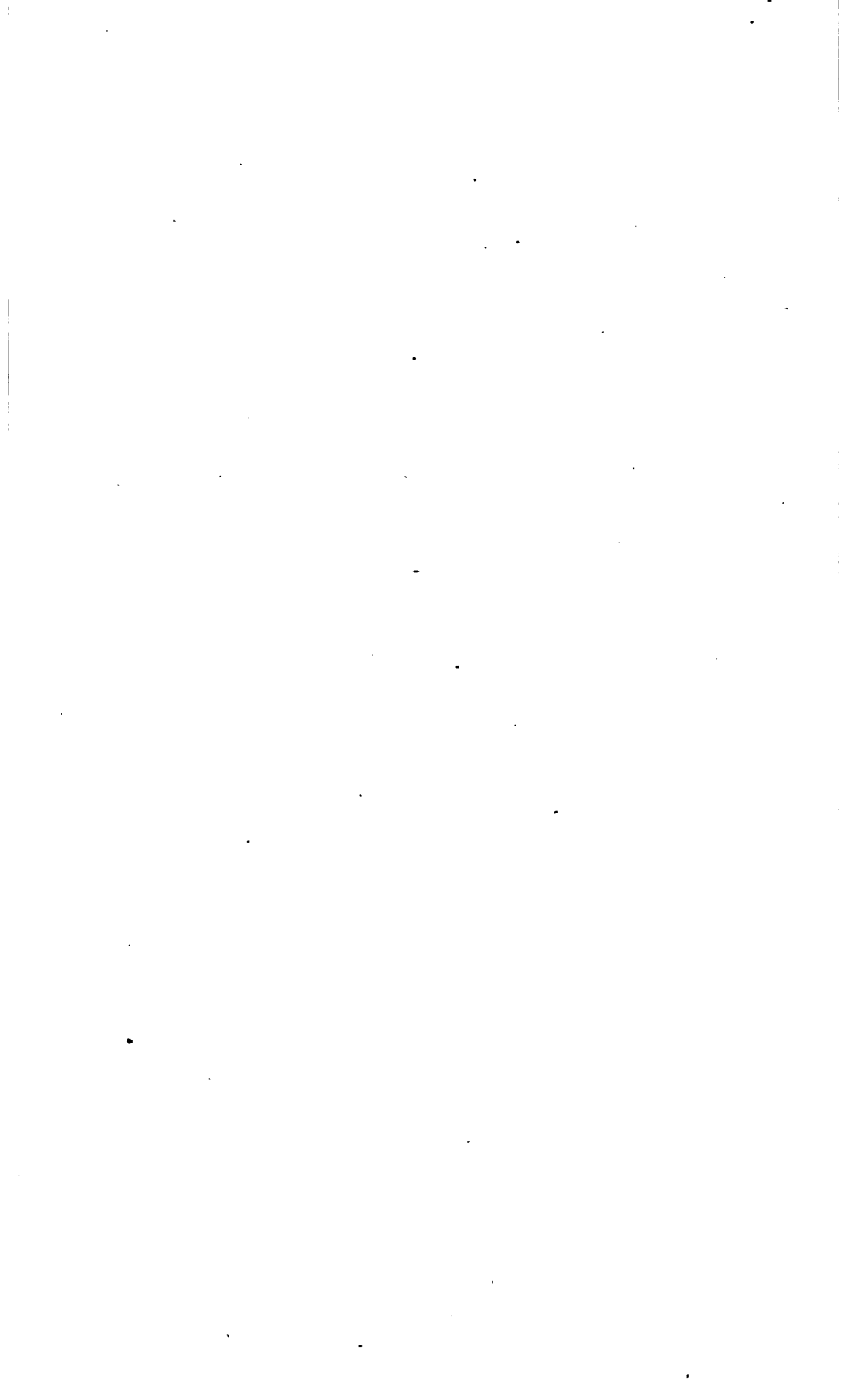

DIVISION III.

SOILS.

CHAPTER I.—CLASSIFICATION OF SOILS.

783. Soils may be classified—

- (a) According to their distance from the village site.
- (b) According to their constituent elements.
- (c) According to the crops for which they are prepared, or which they usually produce.

CHAPTER II.—SOILS CLASSIFIED ACCORDING TO THEIR DISTANCE FROM THE VILLAGE SITE.

784. The concentric circles (बसन्दा *halka*) are generally, but not always, three in number. The nomenclature and division differ according to locality.

- (a) The belt near the homestead, which is better manured, more carefully cultivated, and adapted for superior kinds of crops. The homestead is called बगारी *abādi*, डीह *dih*, बसन्ती *basti*; and the belt of land गोएड़ा *goēnr*, गोएड़ा *goenra*, गोंदा *gonrha*, or गौंदा *gaunrha* or बाध *bādh*; also कोरार *korār* in Patna and to the west, दिहांस *dihāns* (Shahabad, Patna, and Gaya), बरबारी *gharbāri* in Patna and South Munger, and. बाड़ी *bāri* in South Bhagalpur. The land actually in the homestead is specially called डीह *dih*, दिहांस *dihāns*, or (in Tirhut) भीठा *bhitha*, and in Champaran भीठा *bhith*. डीह *dih* is properly an old village site or mound. If there are two clusters of dwellings of the same name some distance apart, the older one will be called डीह *dih*. बगारी *abādi* is properly settled or cultivated land. The land near the village which receives the drainage of the houses is गोदान *gohān* in Shahabad.

- (b) The next furthest belt from the village site is *बहारन्धी* *baharsi* to the west and in Patna and South Munger. This belt is also called *सरेह* *sareh* to the south-west as long as crops are standing on it. It is also called *ताडी* *tādhi* (Champaran), *बहारन्धूम* *baharbhūm* (Saran and Tirhut), *ताड़* *tār* (South-East Tirhut), *बहिहार* *bahiyār* (North-East Tirhut), and *बैहार* *baihār* (South Bhagalpur). In Hazaribagh it is called *सिंघा* *singha*.
- (c) The belt furthest from the village site is also called *सरेह* *sareh* to the west, also *बहारन्धूम* *baharbhūm* in South Munger. So that the second and third belts are only considered as one. There are also, however, separate names for the third belt, viz. *ताड़* *tār*, *ताँड़* *tānr*, or *ताँड़ी* *tānri*, which is used to mean high extensive wastes of infertile or gravelly soil, or of hillocks and ridges such as are found in Gaya, and *चाँर* *chaunr*, which means low open marshy country. In South Bhagalpur *भौडो* *bhitto* is the land far from the village site which only produces bhadoi crops with much labour, and a still further circle is *बरन* *baran*, which bears no produce. In Saran and Tirhut *दीवर* *diyār* are the fields situated on the further side of a river, or islands formed by rivers.

CHAPTER III.—SOILS CLASSIFIED ACCORDING TO THEIR CONSTITUENT ELEMENTS.

785. *Sandy soils.*—*बाहा* *bala* or *बहवा* *bahva*, *बलहार* *balthar* (North-West and in Patna and in Gaya), *बहवाह* *bahvāh* (South Bhagalpur), and *बलधूस* *baldhūs* (Champaran), are soils principally composed of sand. Sandy loams are *बलसुन्दर* *balsundar* or *बलसुन्दरी* *balsundri*, with local variants *बलसुन* *balsun* or *बलसुन्ही* *balsumhi* in South Tirhut, *बलकसी* *balkasi* in South-East Tirhut, and *बलसुम* *balsum* in North-East Tirhut. They are also called *बलुवाट* *baluat* to the west, and *बलिमत* *balimat* in Shahabad. North of the Ganges and in South Munger *बलुवा* *balua* is land with sand on the surface and clay at some distance below. In Champaran and South-West Tirhut *धूस* *dhūs* or *धुसी* *dhūsi* is an arid and sterile soil consisting of an admixture of sand and clay. A loose sandy subsoil, in which a clay well will not work, is *बंगा* *benga* or *बंगवा* *bengua*. In South-East Tirhut it is also

बुसुनी *bhusni*. In Shahabad जीब *bhis* is fine compact sand, and बाबा *bāla* loose coarse sand.

786. *Clayey soils*.—The principal is मटियार *matiyār*, or in Gaya मटिगर *matigar*, which is a brown clay soil, well adapted for rice. It contains about 60 or 70 per cent of clay. A stronger kind, containing about 85 per cent, is called केवाल *kewāl*. This is also called करार *karār* in the south-east. केवाल *kewāl* in South Munger is of three kinds, viz. करका *karka*, which is black; गोरिचहा *goriatta*, which is yellowish; and चणकी *chanki* or गगरी केवाल *gagri kewāl*, which is mixed with fine gravel. This last is also called पथरटिया *pathratiya* in South Bhagalpur or (when it is of a reddish colour) गोरंटिया पथरौटी *gorentiya pathrauti*. In South-East Tirhut केवाल *kewāl* is of two kinds, viz. गौरी केवाल *gori kewāl*, which is light-coloured, and तेलिया केवाल *teliya kewāl*, which is dark. करैल *karail* to the west is a bluish-black soil, which contains more organic matter than मटियार *matiyār*. In Shahabad it is divided into two kinds, viz. बांगर करैल *bāngar karail*, which is apt to crack on drying, and डोना करैल *dona karail*, which is of a more bluish colour than the other. A clay which feels greasy when rubbed in the hand is called दूधी *dādhi* or चिकन मिट्टी *chikkan mitti* or चिकनी मिट्टी *chikni mitti*; and बुसुरी *bhusuri* (west) and कचौष *kachaus* (east) are clay soils which soon dry on the surface. रकौर *rakhaur* is a similar soil mixed with ashes, which is called in South Munger भसुराही *bhasurāhi*. चणकी *chanki*, or to the west सिग्ता *sigta*, are hard soils, which split and crack when dry. In Patna and Gaya कछुरवा *kachhuiya* is a loose clay met in digging wells. लकनी मिट्टी *lalki mitti* north of the Ganges, गेरु *geru* south of it, and काबिस *kābis* in South-West Shahabad, is a red clay. नरम *naram*, and also to the east लरम *laram*, mean soft when applied to clay. North of the Ganges, to the west, and in South Munger, अक्राह *akrah* is a hard clay soil mixed with fine gravel. In South-East Tirhut it is चर्राही *chharāhi*. रोरियाह *roriyāh* or रोरहा *rorha* is land which goes into hard lumps the size of eggs after preparation. कुमरौटी *kumrauti*, or in Saran कुमरौटी *kumr-hauti*, and in Tirhut कारी माटी *kāri māti*, is potter's clay.

787. *Loamy soils*.—The चहाल *chahal* or कदौर *kadoi* is that which is never drier than mud, and in which crops are planted without ploughing. डबरी *dhabri* or डाब *dhāb* is land which is part of the year under water and part of it dry. दोरस *doras*, or (in Patna and Gaya) दोरसाही *dorsāhi*, and (in South Bhagalpur) परसोती *parsoti*, and also

पंचकटेल *panchkatail* in Tirhut, is a clayey loam; while बलुण्डर *balsundar* (see sandy soils for other names) is a fine sandy loam. In Champāran बलुनी *balhni* is a light red soil.

CHAPTER IV.—SOILS AND WATER ACTION.

788. Land thrown up by fluvial action is गङ्ग बरार *gang barār* (also spelt बड़ार *baḍār*), and that cut away गङ्ग सिकस *gang sikast*. चारन *chhāran* is land left by the retrocession of a river. तँर *tānr* in South-West Shahabad, and पटपर *patpar* in South-East Bihār, is newly-formed land so situated as to receive an annual accretion of alluvial deposit; but in Sāran and South Tirhut पटपर *patpar* is barren alluviated land. In Sāran मामस *māmas* is rich alluviated land. In Tirhut, Patna, Gaya, and the south-east तरी *tari* means moist soil in hollows and at the foot of slopes. It also even means water. Thus they say, 'Are you going तरी *tari* (by water) or खुसकी *khuski* (by land) ?' In Sāran तरनी *taryāni* is similarly used. तरी *tari* is also applied to lands recovered by retrocession of a river. In Shahabad they are भागर *bhāgar*, and in the south-west of that district चिहलिया *chhichlahiya*. They are also called चारन *chhāran*. दीयर *diyār* or दियारा *diyāra* is fresh land thrown up by the shifting of the course of a river. In Patna, and also in Champāran, it is called दिवरा *diara*, in South-West Shahabad दीला *dila*, in South Munger दौरा *dīra*, and in South Bhagalpur दौरा *dīra*. The alluvial deposit left by rivers while still wet is called कदर *kadaī*, कदोर *kadoī*, or पंक *pānk* or पङ्क *pank* (see § 789). Land rendered useless by deposits of sand is called कोरा बाळ *kora bāl* (in Sāran) and बलान *balān* (North-West Tirhut).

CHAPTER V.—MUDDY AND WATER-LOGGED SOILS.

789. Land in the bed of a tank is in Patna and Gaya तरी *tari*. In Shahabad it is कौच *kinch*, and to the west generally कानो किचर *kāno kichchar*. Marshy or muddy soils and quagmires are भास *bhās* and दलकी *dalki* to the west and in Patna, and the latter also in Gaya and South Munger. In Tirhut, Sāran, and Patna they are दलदल *daldal*, in Patna and Shahabad पंकवा *pankha*, and in the south-west of the last district खंचरा *khanchra*. Lands usually saturated with water are पनमार *panmār* north of the Ganges, सुगरा *sugra* in South-

West Shahabad, सिंदाह *siñrah* in the rest of the district, सिंदाहा *siraha* in Patna and South Munger, सीरा *sira* in South Bhagalpur, and सेजल *set* in Gaya. धसना *dhasna* is land liable to be submerged. It is called गौंची *gaunchi* in Gaya and जलकी *jalki* in South-West Shahabad; in South Munger it is गौंची *gaunchhi*. The old dry bed of a river is चारन *chhāran* or (in North Tirhut) मरन *maran*. Other names are बाँड़ *bānr* in Patna and Shahabad and जोर *jhor* in the south-west of the last district. पाँक *pānk*, पाँकी *pānki*, or पड़ *pānk* is earth wet and soft so as to yield to the tread, adhesive and rotting. Nothing will grow in it. कादो *kādo*, कदोर *kadoi*, or कदर *kadaī*, is mud in which crops will grow.

CHAPTER VI.—HIGHLANDS AND LOWLANDS.

790. Highlands, as contrasted with river valleys, are उपरगार *uparwār* in Patna and to the north-west, बहरभूम *baharbhūm* in South Tirhut, and उपरार *uprār* in East Tirhut. South of the Ganges दिहांस *dihāns* is used in Patna, ताँड़ *tānr* in Gaya and South Munger, डीह *dih* in Shahabad, and डीह *dih* in South Bhagalpur. In Hazaribāgh other names are उचास *uchās* and डीबर *dhibar*. In South Munger गार *gād* is the corresponding word for a lowland. जीह *jih* or चौर *chauhr*, or in Saran काह *kāchh*, is low marshy land. In Patna, Gaya, and South Munger it is जाह *jāh*. मन *man* is a large sheet of water of considerable depth, and in Tirhut जान *jān* is similar but something smaller. खाल *khāl*, खालना *khālwa*, or in the north-west खालर *khalār* or खालहर *khalhar*, is a hollow with or without water.

CHAPTER VII.—RAVINES AND MOUNDS, &c.

791. Land cut by ravines and broken ground is बिहार *bihar* or (in Gaya) बीहानर *bihanr*. In South Bhagalpur it is अरियन *arian*. The elevated soil in the midst of ravines is डूह *dhūh* or डूही *dhūhi* in South-West Shahabad, डीह *dih* in the rest of the district, टिहा *tilha* in Patna, Gaya, and South Munger, and टिकर *tikkar* in South Bhagalpur.

792. In Patna, Gaya, and South Munger टंरुवा *tānrwa* or नाला *nāla* is a ravine. The latter word is also current to the west, and is only used when the ravine is also a water-course. In the south-east

the word is **दाँड़** *dāur*. **देड़ कौवा** *derh kawa* is also used in Patna. Uneven ground is **उभर बाबर** *ubhar khābar* to the north-west and in South-East Tirhut, and **मठवा** *matha* or **दाबर** *dābar* (also in Champāran) in North-East Tirhut. South of the Ganges we have **अबर बाबर** *ābar khābar* in Patna, Gaya, and South Munger (also noted in Saran), **अंच बाब** *ānch khāl* in Patna and to the west, **अखर बाबर** *ākhar khābar* in Shahabad, and **अबन्ही** *uohī* in South Bhagalpur. A high river bluff is **करारा** *karāra*, **अररा** *arra*, **अरार** *arār*, **अरारि** *arāri* or **कखर** *kachhār* or **कखरा** *kachhāra*. Other names are **दाह** *dhāh* (north generally) and **कंगनिया** *kanganiya* (North-East Tirhut). The sloping bank of a river is in Shahabad **तरगिचर** *tarsiudāi*, and in South Munger **तरि** *tari*.

793. A mound generally is **टिहा** *tilha*, or in South Munger **टिहा टाकर** *tilha tākar*. In South-West Shahabad it is **दूह** *dhuh*, **दूही** *dhūhi* (also in Saran), **डीह** *dih*, or **डिहा** *dilla*, in the rest of that district **टीपुर** *tipur*, and in South Bhagalpur **टिकोर** *tikor* or **टिहार** *tikkar*. In South-West Shahabad **पटपरी** *patpari* is a hill with a flat top. The sites of ruined villages are **डीह** *dih*; also **बीठा** *bhitha* in South Munger. The sites of old villages are often covered with potsherds, hence such sites are also called **ठिकराहू** *thikrāhu* in Patna, **ठिकरौल** *thikraul* in Saran, **ठिकरिया** *thikariya* to the east, **जिकरौर** *jhiktaur* in Patna, Gaya, and Champāran, **सिकरौर** *sikraur* or **जिकरौर** *jhikraur* in Shahabad, and **जिकरिया** *jhiktiya* in South Bhagalpur, the words for potsherds being **जिकरा** *jhikra*, **जिकरी** *jhikri*, or **ठीकर** *thikar* or **ठिकरा** *thikra*, also **सिकरा** *sikra* in Shahabad and **जिकरा** *jhikra* to the west.

CHAPTER VIII.—STONY SOILS.

794. Gravelly soils are **कंकराही** *kankrāhi* in Saran and Patna, **अंकरील** *ankrail* in Saran, and **अंकरौर** *ankraur* to the west. Gravel generally is in Patna and to the west **अंकर** *ankar*, and to the east **गंगट** *gangat*; also everywhere **कंकर** *kankar*. In Champāran and Tirhut it is **इंकरी** *inkri*, and in Champāran and Gaya **जिकरी** *jhikri* or **गरंगट** *garāngat*. Coarse gravel is in Shahabad **अंकरा** *ankra*, and fine **अंकरी** *ankri*. To the south-east it is **गंगटा** *gangta* and **गंगटी** *gangti*. Soil mixed with coarse gravel is **गंगटियाहा** *gangtiyāha* in Patna, Gaya, and South Bhagalpur, and **गंगटाहा** *gangtāha* in Patna and South Munger. **चटान** *chatān* is a hard rocky soil. Other names are **दोहर** *dohar* in South-West Shahabad, and **पथरेहर** *pathrehar* in South Munger.

CHAPTER IX.—CULTIVATED AND WASTE.

795. Classifying soils according to cultivation, we have cultivated land known as **अबाद** *abād* or **अबादी** *abādi*. It is also known in the south-east and Gaya as **पह** *pah*, in Patna as **खील** **बैठाखील** *khil baithāōi*, and Shahabad as **खिलमर** *khilmār*.

796. An inhabited village is **बसगित** *basgit* or **बसनी** *basti*, and a deserted village **बे छपर** *be chhapper* (unroofed), and also in South Munger **निचिराकी** *nichirāki* (without a light) and in Gaya **दमका** *damka*. Other names for the latter are **उजड़** *ujar*, **उजरल** *ujral*, **उजाड़** *ujār*, **उजाड़ा** *ujra* or (optionally in Tirhut) **डीह** *dih*.

797. Waste land is **परत** *parit* (Patna, Gaya, and South Munger) or **परनी** *partī*. Land which has accidentally gone out of cultivation is specially **परात** *parāt* in Saran, **पराता** *parāta* to the north-west, and **परांत** *parānt* or **परना** *parna* in North Tirhut. Waste land broken up for the first time is **खील** *khil*, or in the south-east **खिलकट** *khilkat* or **खिलकटी** *khilkatti*. In Tirhut it is also called **खिलमर** *khilmār*. The second year after it is broken up it is **खील** *khil* to the north-west, **पह** *pah* in Tirhut, Shahabad, and the south-east, and **पौह** *pauh* in Patna and South Munger. The third year it is called **खेत** *khet* or (in Champāran) **पही** *pahi*, and North-East Tirhut **पह** *pah*.

CHAPTER X.—FALLOW.

798. Land left fallow for sugar-cane from the previous spring harvest till the season for sowing the cane is called **मघार** *maghār*, &c., see § 805. Land left uncropped in the autumn harvest and ploughed during the rains for the cereals of the spring harvest following is **चौमस** *chaumās*, and to the west also **पलिहार** *palihar*. Those lands on which a spring crop is sown without any interval after the autumn crop is cut are called **नारी** *nāri* in Patna and South Munger, and **जरी** *jari* or **जरी खेत** *jari khat* elsewhere south of the Ganges and in Saran. Waste lands which are ploughed up during the rains and cold weather and sown in rice at the commencement of the next rainy season are called **दोतरा चौमस** *dotra chaumās* in North-West Tirhut, **गजाड़** *gajānr* in South-East Tirhut, **बिरार** *birār* in South-East Bihār, and **कुलहार** *kulhar* in the south-west.

799. Lands left fallow for a time to recover their strength are **परनी** *partī* generally. Other names are **परना** *parna* in North Tirhut

and चाँच *chānch* in South Bhagalpur. Land which never lies fallow is बबाद *abād* or बबादी *abādi*. Another name is उठनी *uthni* in Champāran. North of the Ganges रल्लि *rulli* or (to the east) रल्लि *runni* is poor-light land which requires to be left fallow for a year or two. It also means land which has lost its fertility. Other words in use are जूस *jhūs* and हलुक *haluk* to the north-west and in Patna, जूसी *jhūsi* in North-East Tirhut, कोदी *korhi* in Patna, चाँच *chhānchh* in Gaya, बंगरा *bangrah* to the south-west of that district, तिलिया कोदी *tiliya korhi* in South Munger, and बल्लनी *algi* in South Bhagalpur.

CHAPTER XI.—RICHNESS AND POORNESS OF SOIL.

800. बरियार *bariyār* or गहरा *gahra*, or in South Munger जैयद *jaiyad*, is the general term used for rich soils. Others are जीगर *jigar* (Patna) and चोखा *chokha* (North-West, Gaya, and South Munger). Poor soils are हलुक *haluk* (North-West Bihar), रल्लि *runni* (see § 799), तपना *tapnāh* (North-East Tirhut), and ठस *thas*, अबार *abbar* (also in Champāran), or उसठ *usath* south of the Ganges.

CHAPTER XII.—IRRIGATED AND DRY LANDS.

801. Land artificially irrigated is पटौचा *patāua* or पटौरी *patāwi* to the west. Other local names are पटौना *patāuna* South-East Tirhut, and पटाचौक *patāōi* North-East Tirhut and पटहुआँ *patāhuāñ* in Shahabad. In Gaya it is हथघिसैट *hathghiset*, and in South-West Shahabad भरैया *bharaiya*. Land irrigated from tanks or ponds is चहान *chhānan* in Sāran and Patna, फोर *phor* in South-West Shahabad, and elsewhere south of the Ganges मेहवानी *mehwāni* or (South Bhagalpur) मेहानी *mehāni*. When irrigated from wells it is मोटवाही *motwāhi* to the west. Unirrigated land, or land which does not require irrigation, owing to its being, or its capability of being, flooded is अपना *apta*. If watered after ploughing, it is चिरिकनी *chhirikni* to the west, पचौआँ *pachauāñ* in South-West Shahabad, and पनौला *panaula* in the rest of that district. निपनियँ *nipaniyāñ* are in Patna unirrigated crops. In South Munger lands which require irrigation are रूना *rūna*, and there and in Sāran those which produce crops without irrigation are हल्लि *halhi*.

CHAPTER XIII.—LANDS WHICH RETAIN AND WHICH DO NOT RETAIN MOISTURE.

802. This is the division most common amongst natives themselves. The moisture in land is *हाल hal*. Land which does not retain it is *बांगर bāngar*, and that which does is *भौट bhīth*, or in North Sāran *भाट bhāth*. Under these divisions come other subdivisions, such as *बलुआ बांगर balua bāngar* (which is sandy), *मटियार बांगर matiyār bāngar* (which is clayey), and so on, and *बलुआ भौट balua bhīth*, *मटियार भौट matiyār bhīth*, and so on. Crops on *bāngar* lands cannot be cultivated without irrigation, and the expense of cultivation is therefore greater, but the yield more than compensates the outlay, being a third, and sometimes double the amount of *bhīth* produce. The latter lands are sometimes irrigated and sometimes not.

CHAPTER XIV.—LANDS BEARING A SINGLE AND A DOUBLE CROP.

803. Lands which produce only one crop in the year are *एकफसलिया ekphasila* or *एकफसली ekphasili*. In Champāran they are called *एकसलिया eksaliya*. *चौमास chaumās* lands (also called *पल्लिहार palihar* to the west) are kept free from crop during the rains, and tilled for the cold weather crop. Lands bearing two crops in the year are *दोफसलिया dophasila* or *दोफसली dophasili*, or in Champāran *दोसलिया dosaliya*. In South Bhagalpur they are *दोसास dosāl*. Land on which crops are grown all the year round is *तिनफसलिया tinphasila*.

CHAPTER XV.—TERMS USED IN CONNECTION WITH DIFFERENT CROPS.

804. The following terms are used in connection with different crops.

805. *Sugar-cane*.—Land prepared for this crop is *उखौव ukhāñw* or *उखाव ukhāo*. Land constantly ploughed for cane or any other crop from Asārh to Magh are *मघात maghāt* in South-East Tirhut, *मघाड़ maghār* in Sāran, Patna, and South Munger, *मघाड़ा maghra* in Gaya and the south-west, and *मघुआ maghua* in South Bhagalpur. Land under cane is *उखारी ukhāri* in Shahabad. *जठरान jathhan* in South Munger is land cropped in the previous year with cane.

806. *Cereals*.—*हरजिन्सा harjinsa* are those lands which grow all crops except transplanted rice.

807. *Garden crops*.—Land suited for growing garden crops is कोरार *korār* in Patna and to the west and कोरिबार *koriyār* in Patna and Gaya. Other names are कोरान्त *korānt* (South Tirhut), कैरिबार *kairiyār* (Shahabad), बारी *bāri* in Tirhut, and लतियानी *latihāni* in South Munger. These names apply rather to the use to which the land is put than to the kind of soil, most of them being connected with the word कोररी *koīri*, which is the name of a well-known caste of garden cultivators.

808. *Cotton*.—In Shahabad the following kinds of land are suited for the various kinds of cotton :—

| Cotton. | Land. |
|--------------------------------------|--------------------------|
| (1) रदिषा <i>rarhiya</i> | करैल <i>karail</i> . |
| (2) बँड्या <i>banrchha</i> | कोरार <i>korār</i> . |
| (3) होवन्ती <i>hevti</i> | परिबार <i>bariyār</i> . |
| (4) मन्गवाँ <i>manwān</i> | नदवाँसी <i>nadwāsi</i> . |

809. *Pulses*.—Land under gram is called चैता *chaita* in South Bhagalpur.

810. *Maizes, millets, &c.*—Land under these crops is दोतुरा *dotura* north of the Ganges. The word means properly land in which both a rainy season and a cold weather crop can be sown.

811. *Spring crops*.—Light friable soil suitable for these crops is called भीठ *bhith* or भीठा *bhitha*, also in Gaya मिठारा *bhithāra*. See, however, § 802.

812. *Rice*.—Rice land is धनहर *dhanhar*. In Gaya it is called धन विचारी *dhan kiyāri*, and in South-West Shahabad धनकर *dhanhar*.

813. *Land under trees, brushwood, &c.*—Forests are बन *ban* or जङ्गल *jangal*. A grove is बगैचा *bagaicha* or गाछी *gāchhi*. बाग *bāg* is a garden, and बगिया *bagiya* an orchard. फुलवारी *phulwāri* is an orchard, enclosed, irrigated, and stocked with fruit-trees. A खाने बाग *khāne bāg* in Champāran and Patna or नजर बाग *najar bāg* in Gaya and Shahabad is a grove attached to a shrine or other building, and growing flowers as well as fruit.

814. A mango grove is आम के बगैचा *ām ke bagaicha*, or in Tirhut गाछी *gāchhi*; a clump of bamboos is बाँस के कोठी *bāns ke kothi* in the north-west, बँसवारी *banswāri* north of the Ganges generally, and बाँसक भीठ *bānsak bith* in North-East Tirhut. In Patna it is बसेर *baser*, in South-West Shahabad बँसवार *banswār*, and elsewhere south of the Ganges बसाड़ *basār*. In South Bhagalpur it is also called बीठो *bitho*, and

in Tirhut ओष *odh*. A young grove of fruit-trees is गहुली *gachhuli* north of the Ganges, also नौराही *naurāhi* in Ohampāran, नरोर *naroi* in Champāran and Tirhut, and लब गहुली *lab gachhuli* or नब गहुली *naw gachhuli* in Tirhut. Another name is नब पेड़ा *nau pera*. South of the Ganges it is लौगाही *laugāchi* to the south-east, केरुवारी *kerwāri* in Shahabad, नरोर *naroi*n in Patna and South Munger, and नौकेड़ा बगैचा *naukera bagaicha* in Gaya. A belt of trees on either side of a road is पान्ती *pānti* or पँतिवारी *pantiyāri*, and also लखरानु *lakhrānu* to the west and पान्ता *pānta* in Tirhut.

815. Land producing brushwood is जारा *jhāra* (Sāran and Patna) or बन छिहली *ban chhihuli* (South-West Shahabad). Brushwood is जार *jhār*, जारवा *jarha*, or to the north-west and in Patna and South Munger जूर *jhūr*. Small stunted brushwood is जखुली *jhakhuli* or जखुरी *jhakhuri* north of the Ganges and in Patna, रौंजी *raunji* in Patna, and जारकन्दी *jharkanti* in South-West Shahabad. Land producing tall thatching-grass is खदौर *kharhaur* or खदौल *kharhaul*, or south of the Ganges खरहर *kharāhur*. Other names are मुजवानी *mujwāni*, कँडवानी *kanrwāni* in the north-west, and मुंजवान *munjwān* in Shahabad. In South Munger it is खरेठा *kharaiṭha*. The principal of these grasses are पटेर *pater*, खर *khar* or खरई *kharai*, रारी *rāri*, डामी *dābhi*, इकर *ikkar* or इकरी *ikri*, मूँज *mūnj* or भलास *jhalās*. Of the last, मूँज *mūnj* is properly the bark used for making string, भलास *jhalās* the leaves used for making rough thatches, काँड़ा *kāṅra* the stout lower part of the stalk used for roof-thatching, and सिरकी *sirki* the upper or reed part used for making sieves and mats. Reeds are नरकत *narkat*, and the land producing them is नरकान *narkān* in Champāran.

CHAPTER XVI.—LAND IMPREGNATED WITH SALT, &c.

816. Land impregnated with impure carbonate of soda रैह (*reh*) is उसर *ūsar* or उसर *ussar*. Other names are रेहाह *rehāh* or रेहाड़ *rehār* (East Tirhut) and रेहड़ा *rehra* (Pātna, Gaya, and South Munger). खारी *khāri* or (South Bhagalpur) खरवा *kharwa* is land impregnated with sulphate of soda. नोनी *noni* south of the Ganges is land impregnated with common salt. Other names are नोनियाह *noniyāh*, नोनियारी *noniyāri*, and नोनहराह *nonchharāh*. In South-West Shahabad चाँप *chāmp*, and in the rest of the district चाँदिल *chāndil*, is उसर *ūsar* land, in which spots of good ground are scattered.



DIVISION IV.

GENERAL AGRICULTURAL OPERATIONS.

SUBDIVISION I.

PLOUGHING AND HARROWING.

CHAPTER I.—PLOUGHING AND HARROWING.

817. To plough is **हर जोतव** *har jotab*, **हर बहव** *har bahab*, or **हर चलाव** *har chalāēb*. **हर नावव** *har nādhav* is properly to yoke the oxen to the plough (also called **हरनी** *larni* in Champāran and South-East Tirhut). Other expressions for ploughing are **सिरावर के बरख** *sirdur ke dharab* or **सरिया के जोतव** *sariya ke jotal* in Champāran, **पैस बरव** *pais dharab* (or **पुरव बरव** *puis dharab* in North-East Tirhut) in Champāran and Tirhut, and **दहिन बरेबाव** *dahin dharedo* in Champāran and South-East Tirhut. One ploughing is **चास** *chās*, and in Gaya and to the west also **बाँह** *bāñh*: thus, **एक बाँह** *ek bāñh* the first ploughing, **दो बाँह** *do bāñh* the second ploughing, and so on.

818. The first ploughing is called **पहिल चास** *pahil chās* or **हरनी** *pharni*. In Gaya and Champāran it is **फारन** *phāran*. Lands sown after a single ploughing are **भोकौवा** *bhokaua* in the north-west and **जोता बावग** *jota bāvag* in Champāran and Tirhut. **मघार जोतव** *maghār jotab* is north of the Ganges and in Patna and Gaya the ploughing in the month of Magh (January–February) of lands intended to be sown at the next rainy season. In East Tirhut and Champāran this is also called **चौमाँस जोतव** *chaumāns jotab*. In Gaya and Champāran it is also **मघरा चास** *maghra chās*, in Shahabad **मघवत** *maghvat*, and in the south-west of that district **कुलहर** *kulhar*. In South Bhagalpur it is **माघी चास** *māghi chās*, and in South Munger **मघार** *maghār*. The field which is thus ploughed is **बिरार** *birār* to the west and south and **पह** *pah* also south of the Ganges and in Champāran. North of the Ganges it is called **चौमाँस** *chaumāns*.

819. The second ploughing is दोबार or दोबाड़ *dokhār*. In Gaya and Champāran it is also called पुर्णे *purve*. Other names are सोमरा *somra* to the north-west and समार *samar* in North-East Tirhut, दोबार *dohār* in Champāran and North-West Tirhut, and दोहरावन *dohrawan* in South-West Shahabad; and the same names are also applied to the field so ploughed. In the south-east the second ploughing is called चार *chās*, दोबार *dokhār* being the third ploughing.

820. The third ploughing is तेबार *tekhār* and also (in Champāran) तेहरा *tekhra*. To the west it is also तेहरावन *tehrawan*. In the south-east it is दोबार *dokhār*. The same terms are used for the land so ploughed.

821. The fourth ploughing is in East Tirhut and Gaya चौबार *chauhār*, and in Shahabad, Gaya, and South Bhagalpur चरचरी *charchasi*. Elsewhere it is चार चार *chār chās*; so also the land so ploughed.

822. The fifth ploughing is पांचचार *pānchās*.

823. The phrase used for successive ploughing is एक चार *ek chās*, दू चार *du chās*, and so on. Theoretically there is no limit to the number of ploughings required for some crops, as is shown in the following rhyme current in Gaya:—

| | |
|-----------------|---------------------------|
| सौ चार गन्दा, | <i>Sau chās ganda,</i> |
| पचास चार मन्दा, | <i>Pachās chās manda,</i> |
| तेकर आधा मोरी | <i>Tekar ādha mori,</i> |
| तेकर आधा तोरी | <i>Tekar ādha tori.</i> |

—A hundred ploughings for cane, fifty for wheat, half that (25) for rice, and half that (12½) for oilseeds.

824. The ploughing of millets, when they are about a foot high, is बिदाह *bidāh*, a local variant being बिदाहनी *bidahni* in Champāran, West Tirhut, Patna, and the south-east. In Gaya and Champāran it is कोरन *koran*, and in South Munger, when hoeing is substituted for ploughing, it is कोरनी *korni*. When a rice-field is flooded and then ploughed to kill the weeds, the process is called लेव *leo* in the north-west, लेवा *lewa* in Gaya, and कादो *kādo* or कदवा *kadwa* to the north-west and in Tirhut. In North-West Tirhut it is called मसाह *masāh*.

825. In Sāran and Champāran ploughing with a plough of which the block is new and full-sized is नवठा के जोत *navtha ke jot*, and

with one which has a small worn block खिनौरी के जोत *khinauri ke jot*. In Tirhut and also in Champāran the corresponding words are respectively लवठा के जोत *lawtha ke jot* and डँडा के जोत *thentha ke jot*, and in Shahabad नवहरा *nawahra* and खुँडेहरा *khuntehra*.

826. In rice cultivation, after sowing, the field is lightly reploughed to clear the weeds and cover the seed. This is called उनाच *unāch* to the north-west and in North-West Tirhut, गजर *gajar* in the North-East Tirhut, and समार *samar* in Champāran and South-East Tirhut. In Patna it is समाच *samāch*, in Gaya विराच *birāch*, to the west and in Patna and Gaya विदाच *bidāch*, and in Champāran and to the south-east विदाचनी *bidāchni*.

827. The small pieces of the field which the plough has not touched are पैस *pais* in Champāran and South-West Tirhut and पुरस *puis* in North-East Tirhut. In North-West and South-East Tirhut and in Champāran they are दहिना *dahina*, and in Sāran and Champāran छूटल खेत *chhūtal khet*.

828. Cross-ploughing is चारा *ara*, or in Champāran and South Bhagalpur चार *ar*, and in South-East Tirhut समार *samar*. When a field is ploughed round and round in constantly diminishing circuits, it is called चौकेठा *chauketha* or (in Patna) चौपटा *chauetha*, चारी.चाच *ari chās* in Gaya, चौबगल्ली *chaubagli* in Champāran and Gaya, and चौगडिया *chaugathiya* or चौक *chauk* to the west. In Sāran and Champāran it is चौगेठ *chaugeth*, in South Munger भौरिया *bhaunriya*, and in North-West Tirhut चौकेर *chauker*. The centre plot in the middle, round which the bullocks have no room to turn, is called बदन्धार *badhār*, and this is furrowed by taking the plough across it diagonally from corner to corner. Ploughing from corner to corner is कोनिया जोत *koniya jot* or कोन *kon*, also कोनग्वी *konsi* in South Munger, कोनसिया *konasiya* in Champāran and South-West Tirhut, कोनी *koni* in Gaya, and कोना कोनी *kona koni* to the west. When a crookedly-shaped field has to be ploughed, it is called अना द्योही जोत *ana dyorhi jot* in Sāran and Patna and अनादेही जोत *ana derhi jot* in Champāran. When a rectangular field is ploughed straight along its length or breadth, the ploughing is called सोझावा जोत *sojhaua jot*. Other names current are डहराई *tharhāiñ* in Patna and Champāran and डहिया *tharhiya* to the west. Ploughing breadthways is फानी *phāni* in Sāran and North-West Tirhut, फटकी *phatki* in Champāran and the south-east, अना फानी *ana phāni* in Patna, and फँदिया *phandiya* in South-West Shahabad.

829. The following rule is current in North-East Bihar as to ploughing and harrowing :—

झोर जोमिहः बहुत जे मरः, ऊँच के वैमिहः चार ।

उपे तः उपे नार्हो तः नार्हे दीरः मार ॥

Thor jotiha bahut hengāiha, unch ke bandhiha ār,

Upje ta upje nāhin, ta Ghāghe dāha gār.

—Plough little, harrow much, and have your field boundaries high. If what should come does not then do so, you can abuse Ghāgh (who gives you this advice).

830. A harrow is जेना *henga*, &c., as described in § 30 and ff. To harrow is जेनाप्रब *hengāēb*, जेना चलाप्रब *henga chalāēb*, or चौके घुमाप्रब *chauki ghumāēb*. The act of harrowing is in Gaya पाहट *pālat*.

831. The oxen attached to a harrow have various names. The one on the left-hand side is called पंचौट *panchaut* or कुदहिन *kurdahina*, and the one next to him हथौवा *hathaua*. The right-hand ox is देरा *phera*, or in South Munger भसनी *bhasni*.

CHAPTER II.—FIELDS.

832. A field is खेत *khet*. Other names also current are डोपरी *topri* and पारी *pāri* south of the Ganges, डोपरा *topra* to the west, and दाबर *dābar* in Champāran and Gaya. In South Bhagalpur the words बारी *bāri* and बहियार *bahiyār* are used. Beds made in a field to facilitate irrigation and for other purposes are कियारी *kiyāri*, and also in Champāran ग्यारी *gharāri*, in Patna and to the south-east गंजारी *ganrāri*, and in Gaya गेंजारी *genrāri*. Similar beds in a sugar-cane field are called हाना बाहा *hāta wāla* to the north-west and in Gaya and North-West Tirhut, and जोर *jhor* or जोरा *jhora* south of the Ganges. In the north-west जोरा *jhora* is a large bed, and so also are पहा *pahta* in Gaya, Saran, and Champāran, परिवा *pariya* in South-West Tirhut, दवान *dawan* in Champāran and North-West Tirhut, and कियारा *kiyāra* or भेर *bher* in East Tirhut. The raised banks between the irrigation beds are मेंर *menr* in the north-west and चार *ār* in Tirhut. In Shahabad, Patna, and Gaya they are करवा *karha*, and in Patna and Gaya पंगरा *panrga*, in South Bhagalpur पलंगा *palanga*, and in South Munger दौग *daug*. North of the Ganges a plot marked off by a boundary is हाना बाहा *hāta wāla* in the north-west and South Munger and चरकी बाहा *chharki bāla* in East Tirhut. The small patch

of ground adjoining a house is कोला *kola*, कोली *koli*, or कोलवार *kolwāi* to the north-west, and बारी *bāri* in Champāran and Tirhut. कोला *kola* also obtains in Shahabad and the south-east. In Sāran and Patna it is खण्ड *khand* or खंड *khān* (which properly means a ruined house), and in Gaya गेवारी *ghewāri*. Other optional names are गल्ली *galli* in South Bhagalpur and कोनासी *kona-si* in Shahabad. When the fields of one proprietor's share are scattered over a village, each is called तख्ता *takhta* or किता *kitta*. The whole cultivation of such a proprietor is called खेती बारी *kheti bāri* to the west and in Tirhut; also खेत बघार *khet badhār* in Shahabad and Patna, and खेत पघार *khet pathār* in Champāran and South Munger. In Patna and Gaya खण्ड *khandh*, खान्धा *khantha*, किता *kitta* or किता *kita*, is a large area of cultivated land. A division of this is खंडौट *khandhaut*, which is again divided into fields.

CHAPTER III.—BOUNDARIES.

833. The low ridge which forms the boundary of a field is everywhere आर *ār*, आरि or आरी *āri*, as in the proverb आरि आरि न कपार छाडी, नीच बङ्गा चरवासी *āri jāi ta kapār lāthi, bich banga charwāsi*,—if you go on a field boundary have a stick (to protect) your head, (and then) you may graze your cattle in the midst of a cotton-field. North of the Ganges it is also called डंडेरु *danrer*. Other names are अहरी *ahri* (see § 919), अलुङ्ग *alung*, or पराँठ *parānth* in Patna, Gaya, and the south-west; पंगरा *panrga*, गंगारी *ganrāri*, आरुल *āil*, or आल *āl* in Gaya and South Munger, and दाँरु *dāur* in South-West Shahabad. A ditch boundary is खै *khāi*, आर *khāi*, खान्धा *khātha*, or खान्धा *khācān*. Another name is खान्धा *khātha* in South Bhagalpur. In Gaya district डोहरा *dobhra* is a small ditch. An embankment used as a boundary is अहरा *ahra* (see § 919) or बाँध *bāndh*. Other names are बरबन *bharban* (Champāran), धूर *dhūr* (North Tirhut), and चरकी *chharki* (South-East Tirhut). A place where three boundaries meet is तिनकोनिया *tinkoniya*, and where four meet चौमुख *chūmukh*, चौबटिया *chaubatiya*, or चौराहा *chaurāha*. In Champāran and South-East Tirhut it is also चौपड़ *chaupar*.

834. The rural Bihari lays great stress on the importance of keeping these boundary embankments in order. Thus, there is a proverb ठारिक चुकल बाजर; थारिक चुकल किसान *thārik chukal bājar, ārik chukal kisan*,—a cultivator who neglects to look after his boundary embankments becomes like a monkey fallen from a branch. Another

proverb which may be noted here is **बेन भाड़े, चारि कोड़ी** *khet bhāse ari kori*,—the field is flooded, cut the boundary embankments, i.e., passion must have its vent.

CHAPTER IV.—FURROWS.

835. A furrow is **चरार** *harāi* to the west. In Champaran and Tirhut it is **सिरादर** *sirdur*, in Patna **सिरोर** *siror*, and elsewhere **सिरौर** *siraur*. In Gaya another name is **सेवात** *sewāt*. **जंजिया** *janjhiya* or **चारी** *dhāri* in Gaya and Saran, and **घरै** *ghai* in Patna and South-East Tirhut, are the deep furrows in a field in which extra crops are grown, especially those at the edge of the field, or running from corner to corner.

836. The deep furrow used as an irrigation channel is **चारा** *āra* in the north-west, **पेन** *pain* or **पेनि** *paini* generally, **दौंगर** *daungar* in South Tirhut, Patna, and Gaya, **नारी** *nāri* or **करवा** *karha* to the west and in Patna and Gaya, **भोता** *bhita* in East Tirhut, and **दौंग** *daug* in Patna and to the south-east.

CHAPTER V.—MISCELLANEOUS TERMS USED IN CONNECTION WITH PLOUGHING.

837. To the west **सँजहे** *sānjh le*, **सँजिया** *sanjhiya*, and **सँजहरिया** *sanjhariya* mean 'up to evening,' or 'at evening' and hence are used as adjectives with the word **जोत** *jot* to signify as much land as can be ploughed in a day. In Champaran and South Munger this is **सगरदिना** *sagardina*, and in Patna **ठकहरिया** *thakhariya*. The area ploughed in half a day is called **दोपहरिया** *dopahariya*.

838. The portion of land included in a plough circuit is **आंतर** *āntar*, and also to the north-west and in North-East Tirhut **हटा** *hattha*, and to commence another circuit is **दोसर आंतर** *dosar āntar* or **धराब** *dharab*. The place where ploughing is going on is **हरवाही** *harwāhi* in Patna and north of the Ganges. In Shahabad it is **हरवाही** *harwāhi*. In Patna it is **दोपतरा** *topra*, and generally **चरठा** *harātha*.

839. The first ploughing of the season is **हरमहतर** *harmahutar* in Saran and **हरमोहतर** *harmohtar* in Patna and Gaya. It is also **समहतर** *samhut*, and to the north **सिरपंचमी** *sirpanchmi* or **सिरपचई** *sirpachai*, both the last two terms being derived from the festival of the *sri*

panchami. In South Munger it is *हर महन्तर har mahantar* or *हर समत har samat*, and in South Bhagalpur *सोमता somata*. Another name current in Sāran is *हरवत harvat*.

*840. The bringing home the plough on the back of a bullock or with the share over the shoulder is *हरखुली harkhuli*, *हरखोलिया harkholiya*, or *हरखुजल harkhūjal*, and in South-East Tirhut (optionally) *हरखुगानी harkhugāni*. In South-West Shahabad it is *हरखुटाव harchhutāo*, and in the rest of the district and in Gaya *हरखुट्टान harchhuttan*. In Patna it is *हरबिनार harbinār* or *हरजोहार harjoār*, in South Munger and Champāran *हरखोलानी harkholāni*, and in Gaya, Champāran, and the South-East *हरखोली harkholi*.

841. The bullocks which draw a plough or harrow are called *बरद barad*, and to the west. also *बैल bail*. When it is wished to distinguish them specially from cart-bullocks, they are called in Champāran and Tirhut *बडा बरद hattha barad*, and to the north-west and in Gaya *बरेबा बैल hareā bail*. A lazy fat plough bullock, which sits down rather than work, is called *कोहि korhi* or *परवा parua*, as in the proverb *कोहि बरद के पेषरि बहुत korhi barad ke phephari bahut*,—it's the lazy bullock that puffs and blows.

CHAPTER VI.—PLOUGHMEN AND AGRICULTURAL LABOURERS GENERALLY.

842. A ploughman is *हरवाहा harwāha*, and to the west also *हरवाह harwāh*. In East Tirhut he is also called *हारी हरौरी harauri*. His wages are called *हरवाही harwāhi*. An agricultural servant in general is *मजूर majūra* or *बनिहार banihār*. An agricultural servant engaged for the whole year is *हरवार harwar* in Sāran and *भरसलिया bharsaliya* in North-East Tirhut, and one for the whole day is *भरदीना bhardina*. A ploughman who works for half a day is *दुपहरिया dupahariya* or *दोपहरिया dopahariya*, or in North-West Tirhut *पहरवार paharwār*. One who works on advances is *अग्वार अग्वार जन agwar (or agwarh) jan* to the north-west, *कमार kamāi* to the west, *कमियाई kamiyaī* or *कमियाँ kamiyañ* in Patna, Gaya, and South Munger, and *लगवा जन lagna jan* generally. The last is usually the man who binds himself to work off a debt incurred. When a ploughman receives the use of a plough for one day in three instead of wages in cash or kind, he is called *अंग्वरिया angwariya* or *अग्वरिया agwariya*, and to the west *अंग्वार angwār*. In Sāran

and Champaran he is also called *तेपटा* *tepta* (so also in North-East Tirhut), or *तिररी* *tisri* or *तिररिया* *tisariya*. In East Tirhut a ploughman who works without advances is called *उत्था* *uttha*, as distinguished from *चरवाहा* *charvaha* or *हरारी* *harauri*, who does take them.

843. In North-East Tirhut *पट* *pat* or *साटी पाटी* *sati pati* is the custom of a plough-owner employing two ploughmen for each plough, each ploughman relieving the other at intervals of eight days. In Shahabad and Patna *हरार* *harai* is the custom under which every tenant lends his plough and bullocks to the landlord for two days in the year.

844. An agricultural labourer paid in kind is *जन* *jan*, also in Gaya and Champaran *उपंगिया* *uphangiya*, and in South-West Shahabad *बनी* *bani*. One who receives money is *नोकर* *nokar*, or in the north-west *जाना* *jana*. One paid solely in cash is called *कोरजा* *koranja* to the north-west. In Patna, Gaya, and South Munger the prædial slaves who are attached to an estate, and cannot leave it, or marry, or in fact do anything without the consent of their landlords, are called *नपर* *naphar* or *कमियाँ* *kamiyān*; and food given to such is *खैरान* *khaihan*. A labourer who by custom works a certain number of days for nothing for Government (formerly, and for the landlord nowadays) is called *बेगार* *begar*. Payments made in kind to agricultural labourers are called *बन* *ban*, or in East Tirhut *बोन* *bon*. Advances to ploughmen are *अगार* *agwar* in the west and *अगारी* *agauri* in South-West Tirhut. Elsewhere in Tirhut and to the north-west they are called *हरारी* *harauri*, and generally *लगुवा* *lagua*.

845. When there are spare bullocks in a field where ploughing is going on to relieve those that get tired, the boy who looks after them is called *अनुवाह* *anuah* in East Tirhut; elsewhere he is *चरवाहा* *charvaha* or *गोरखिया* *gorkhiya*.

CHAPTER VII.—RECIPROCAL ASSISTANCE IN CULTIVATION.

846. *बदलीवा* *badlaiya* and *पल्लाटा* *patta* or *पल्लाटी* *patti* are terms for exchange of labour for labour by agriculturists. To the west it is also called *पैच* *painch*, in Gaya *बदली* *badli*, and to the south generally *पापठ* *pāeth*. In East Tirhut another name is *जानपैचा* *janpaincha*. The practice of two or more cultivators joining their

ploughs and ploughing together, first the field of one and then the field of another, is called generally **बाँज** *bhānj*. Other names are **भंजहारिवा** *bhanjhariya* and **हर सज्जा** *har sajjha* to the west generally **भजौती** *bhanjauti* in North-East Tirhut, **हर भज्जा** *har bhanja* in Patna and to the north, **हर पहाटा** *har pahta* in Champāran and Gaya, **भंजैठ** *bhanjeth* in South-East Bihar, and **बाँजो** *bhānjo* in South Bhagalpur. The cultivator in this case is **बाँजा बाबा** *bhānjā wāla*, or in Tirhut **भंजैत** *bhanjait*. Another name current to the west is **अंगवारा** *angwāra*, though this properly refers to the custom of paying ploughmen (**अंगवरिवा** *angwariya*, see last chapter) by lending them a plough and cattle one day in three.

847. The work which one cultivator does for another in this way is called to the west **सापठ** *sāpat*.

SUBDIVISION II.

MANURING.

CHAPTER I.—KINDS OF MANURE.

848. Manure is north of the Ganges **खार** *khadar*, **खदौर** *khadaur*, **खदी** *khaddhi*, or **गोंदौरा** *gondaura* to the west, and **गोषा** *goa* or **करसी** *karsi* to the east. South of the Ganges, to the west, it is **घूर** *ghūr*, and to the east (also in Saran) **गनौरा** *ganaura* or **गंदौरा** *gandaura*. **कूड़ा** *kūra*, **कूड़ा कुरकूट** *kūra kurkut*, **बहारन** *bahāran*, or (in South-East Tirhut) **गोनरौर** *gonraur*, is rubbish or road-sweepings. Cowdung is **गोबर** *gobar*. When dried it is called south of the Ganges **दमार** *dāmāra*, of which a variant in East Tirhut is **दमार** *damār*, also in Shahabad and Patna **कडा** *kanda*, and to the west **कंररा** *kanrra*. The latter term is also used in Saran. In North-East Tirhut it is **गौठि** *gauthi*, and in Champāran **गौठी** *gauthi*. In Gaya **फेंडी** *phenti* are pieces of dried cowdung. **चोट** *chot* to the west is the quantity that falls from an animal at one evacuation. Cattle urine is **गौत** *gaunt* or **गौत** *gaut*, and to the west also **मूत** *mūt*. **खीद** *līd*, **खिदी** *liddi*, or **खीदी** *līdi* is the dung of horses, elephants, &c., and that of sheep or goats is **भेंडाड़ी** *bhenrāri*, **भेनाड़ी** *bhenāri*, or (to the west) **लेंडी** *lenri*. Other filth of various kinds is **मैला** *maila*, or in South Bhagalpur **घिना** *ghina*. The refuse of indigo after maceration used as manure is **सिठ** *sith*.

849. A manure heap near a house is धेरी *dheri*, or (in East Tirhut) गोनर *gonar*.* North of the Ganges generally it is also मान *mān*. A manure-pit is घूर *ghūr*, खाद *khād*, or खाद के गड्ढा *khādar ke garha*. A heap of dried grass, sweepings, dung, &c., is in North-East Tirhut and Shahabad कूर *kūr*. Ashes are राख *rākh* or खाकर *chhāūr*, and in South Bhagalpur चौरो *chhauro*. In Patna and Gaya they are बानी *bāni*. An ash-heap is in North-East Tirhut चौराठ *chhaurāth*.

CHAPTER II.—MODES OF MANURING.

850. Heavily-manured land is north of the Ganges खदौर खेत *khadaur khet*, or it is called गोबरगाछ *gobrāēl*, or in South-East Tirhut भरल *bharal*. South of the Ganges it is खदौर *khadaur*, खदगौर *khadgaur*, or खरित *kharit* in Shahabad.

851. The custom of allowing cattle to stand in a field for the purpose of manuring it is called north of the Ganges भेंड़ी बेसाबोल *bhenri baisāöl* or भेंड़ी बिराबोल *bhenri hirāöl*; south of the Ganges it is जिवगर चोग खा घूर बेसाबोल *jivgar hoë la dhūr baisāöl*, and in South Munger they say खेत गोबरखे *khet gobrābe heñ*.

CHAPTER III.—MANURE USED AS FUEL.

852. Manure collected in the forests and grazing-grounds and dried for fuel is called north of the Ganges कंडका *kanra* or करका *karra*. South of the Ganges it is दमारा *damāra* or कडा *kanda*. In East Tirhut it is दमार *damār*, and to the west it is also called बिहुवा गोरठा *binua goītha*. Another general name is बन गोरठा *ban goītha*. When made up into cakes with chaff and other refuse, the large oblong blocks are called गोहरा *gohra* to the west and गोरठा *gorha* in Champaran and to the east. The next sized round cakes which are stuck on the wall to dry are गौंठा *goīntha* or गोरठा *goītha*. The smallest cakes are चिपरी *chipri*. The largest-sized slabs made with both hands are दोहथा *dohtha* or सोथी *sothi*. करसी *karsi*, or in Gaya and South Munger अमारी *amāri*,

* Compare for an example of this word the proverb गोघरक गोनर दुहु दिख सिद्धन *goārak gonar duhu dis chikkan*,—a *gowāla's* dunghill is neat on both sides.

are unmanufactured lumps of dry cowdung dried and stored.

853. The pile of cowdung fuel is called to the west गोहरौर *gohraur* or गोहरौरा *gohraura*. In North-East Tirhut it is गोहौर *gothaur*, in Champāran गोहौला *gothāula*, and there and in Tirhut राह *tal*. It is छुहा *chhāa* optionally to the west, छुहा *chhāha* or छुही *chhāhi* in Patna and Gaya छुहा खन्ना *chhua chhanna* in South Munger, and खानी *chhāni* in South Bhagalpur. The pile of the large oblong blocks is also called गोहरा *gohra* or गोरहा *gorha* as above. The house in which the fuel is stored is गोहौर *gothaur*, गोहौरा *gothaura*, or गोहौल *gothaul* generally; also गोहल *gothul* in North-East Tirhut, गोहल *gothāhul* in Shahabad, and गोहल घर *gothā ghar* in Gaya. The operation of making the cakes is पाथ *pāthab* or पाथल *pāthal*, according to locality, or else थोक *thokab* or थोकल *thokal*. The place where they are made is north of the Ganges generally पथारी *pathāri*. South of the Ganges it is पथरौर *pathraur* in the west, धारा *dra* in Gaya, and पौर *pānrar* in Patna.

854. In selling cowdung fuel a पन *pan* equals 20, 22, or 23 गन्दा *ganda* (i.e. fours), according to locality. In buying the article in Patna the seller gives two cakes extra (called a पनकी *panki*) for every पन *pan* bought.

SUBDIVISION III.

SOWING AND TRANSPLANTING.

CHAPTER I.—SOWING.

855. *Sowing* is to the west बोनी *boāni*, and to the east बावग *bāwag*, बाबोग *bāög*, or बावग *bāüg*. South of the Ganges, and also in Champāran, it is also बोहार *boāi*, or in Patna and South Munger बोनी *boni*. In South Bhagalpur (and also in Champāran) the word is बोनी *boani*. To sow is north of the Ganges, बोहल *boāl*, बावग कर *bāwag karab*, बून *būnab*, or बूनल *būnal*, according to locality. To scatter the seed is generally छिट *chhitab* or छिंट *chhintab*. In Patna चुलाप्र *chuldāb* is also used in connection with *Bhadoi* or autumn crops.

856. *Seed* is बीया *biya* or बीजन *bihan*. In Gaya it is बिहन्ना *bihnāi* (also used in Champāran), बिच्चा *bichcha*, or गोटा *gota*, and in South Bhagalpur बिन्हा *binhāi*. A grain of seed is दाना *dāna*.

Barren seeds are चन्नी *abbi* (or in Shahabad) चक्क *awai*, and fertile seeds are सुखी *suggi*.

CHAPTER II.—MODES OF SOWING.

857. The following are the modes of sowing:—

- (a) *Furrow sowing.*—चारी *dhāri* or चरिवा *dhariya*. To plough in this way is चारी लगायब *dhāri lagāēb* or चरिवायब *dhariyāēb*. South of the Ganges this method is called चुटकी *chutki*. In this method a plough goes in advance of the sower, who carries the seed in a basket. He drops it into the furrow as soon as the latter becomes visible. By this method the seed is sown deep, the stalk is stronger, and not so liable to be laid by high winds. भडायब *bhaḥāēb*, दोचरिवा *dodhariya*, दोचार *dohār*, or चमार *samār* is the practice of filling up with soil the furrow in which the seed has been sown, by ploughing a separate furrow beside it. This is generally done in the case of *Bhadoi* crops. Sugar-cane is not covered in this way in Bihar, but by hand. The long straight lines of seed across a field are known as चारी *dhāri* or पंती *pānti*. When the ploughing is done round a field, and not across, it is called चौकेडा *chauketha*, &c. (See § 828).
- (b) *Sowing by drill.*—This is तार *tār*, चारी *tāri*, टोर *tor*, टोरी *tori*, often spelt टॉर, टॉइ *tānr*, टॉर, टॉइ *tonr*, &c. To sow in this way is तारब *tārab* or टोर लगायब *tor lagāēb*. The man who works the drill-plough is तरवाह *tarvāh* or टोरवाह *torvāh*.
- (c) *Broadcast sowing.*—This is generally बाबा *bāwag* or its variants,—see above. Other names are चिहा *chhitta* or चिहुवा *chhitua* north of the Ganges, and चिंटा *chhinta* south of it. Maize and similar crops are sometimes sown broadcast on land left soft after an inundation, and are then pressed into the mud by hand. This method of sowing is called डोभा *dobha*, and to sow thus is डोभव *dobhab*.

858. If the seed is sown on lands which have not been ploughed, it is called *चिहा chhitta*, *चिहुवा chhitua*, or south of the Ganges *जंगली बावर jangli bāwag*, *पैरा paira* (Gaya, also in Champaran), or *पापर pāer* or *समार samār* (Patna and South Munger). *चौटा chhintā* or *चिहा chhitta* is also used to signify lands in which the seed has been scattered after a single ploughing. It is also specially used for sowing the spring (*रबी rabi*) crops on the *दोफसिला dophasila* lands, i.e., those from which the autumn crop has just been cut, as contrasted with the *पलिहार palihar* or *चौमास chaumās*, which are carefully-prepared fallow lands for wheat and similar crops. The sowing of the early rice in dry lands is *खरखर बावग kharhar bāwag*. North of the Ganges it is also *धुरिया बावग dhuriya bāwag*. South of the Ganges it is in Shahabad and Patna *ठररा tharra*, in the rest of the district *खरवाह kharwāh*, in Gaya *खरवेह kharveh* or *खरवे kharve*, in Patna *बौवा baugha*, and in South Munger *धुरहुसा dhurghussa*. In Patna and Gaya sowing in a wet field is called *लेवा lewa*. Sowing wide apart is generally *पानर pātar*. Other names are (north of the Ganges) *फकाह phakāh* or *फांफर phānphar* to the west and *चेहर chhehar* or *चेरमार permār* generally. South of the Ganges we find *पापर pāthar* in Gaya, *पतला patla* in South Munger, and *पतौल patil* in South Bhagalpur, the last two being also met with in Champaran. Sowing thick is generally *घन ghan*, *गाढ़ gārh*, or *गाढ़ा gārha*. North of the Ganges *सजोर sajor* is used in the same sense.

859. Grain that fails to germinate is *अबी abbi*, *निरन्वीज nirbij*, *बिजमार bijmār*, or *बीवा मार biya mār*. In South-West Shahabad it is *बरवा barua*. If a man wishes to say that his seeds have not come up, he says *खमार बिजमार मारल गेल hammar bihnāi mārāl gel*.

860. When from excess of rain followed by heat a crust is formed on the surface, which prevents the young plant from coming up, it is called to the west *सपट जारल sapat jāil* or *सपटा जारल saptā jāil*. In East Tirhut and Shahabad it is called *सपरी papri*. South of the Ganges it is *तावा tāwa* to the south-west of Shahabad, or *सेवडा sewtha* in the rest of the district and in Patna. Elsewhere it is *सेवडा sewta* or *हुदा munda*.

861. *Self-sown seed*.—Seed which falls on the ground in the field at harvest time, and which germinates next year, is called *लमेरा lamera* in the west, *नमरो namhero* in South Bhagalpur, and *नमर namher*, *लमेर lamher*, or *लाम lam* in South Munger.

CHAPTER III.—SEED-BEDS AND NURSERIES.

862. A nursery for rice is बिहार *birār* or बिहार *biyār*. To the west it is also बेंगा *benga*. The young plants which are transplanted from the nursery are generally बीया *biya* or गाछी *gāchhi*. They are also called बीजन *bihan* or बीजनार *bihnāi*. South of the Ganges and to the north-west (when of rice) they are also called मोरी *mōri*, and in Champāran जराई *jarai*. The bundles of rice seedlings ready for transplanting are अँटि *anti* or अँटिया *antiya*.

CHAPTER IV.—SOWING TIME.

863. The sowing season is बीजनी *boāni* north of the Ganges and बीजना *bogha* south of it. It is also generally called बावण *bāvaṅ*.

CHAPTER V.—TRANSPLANTING.

864. To transplant is रोपण *ropab*. In Gaya when a man has finished transplanting he says हमार बहुवार जेह *hammar banusār bheh*,—‘I have finished transplanting,’ the quantity of rice seedlings transplanted at one place being called everywhere except in the south-east बाण *bān*. A bundle of seedlings is अँटि *anti*, and the man who plants them is called डोभा *dobha* or रोपनिहार *ropnihār*. The bundles are tied in pairs and set astride over a long bamboo when carried about. This bamboo is called to the west बिहणन्डोवा *bihandhoa* or कनाठ *kanāth*. The man who roots up the seedlings from the seed-bed is called कबरिया *kabariya*, or in Sāran कबरिया *kabariha*. In South Munger he is also called मोरकबरा *morkabra*. Seedlings which have been re-transplanted, i.e., transplanted more than once, are called north of the Ganges खार *khāru* or खरुहन *kharuhan*.

SUBDIVISION IV.

DIGGING, HOEING, AND WEEDING.

CHAPTER I.—DIGGING.

865. To dig is कोदण *kōrab*. In Champāran and Tirhut it is also तामब *tāmab* or पारब *pārab*. In South-West Shahabad it is देवब

chhejal. Digging is कोड़णी *korni*, also in Champāran and Tirhut तमनी *tamni*, in Patna, Gaya, and South Munger निकौनी *nikauni*, and in South-West Shahabad छेजनी *chhejni*. In South Bhagalpur it is कोड़न *koran* or खँड़ *khanr*. In Saran and Champāran गोहट *gohat* is digging or hoeing the edges of fields. In Tirhut this is called चारि हाँटब *ari chhāntab*.

CHAPTER II.—HOEING.

866. Hoeing is खुरपियाना *khurpiyāna* to the north-west. In Champāran and in Tirhut generally it is केरौनी *kerāuni* or कामेनी *kamaini*. South of the Ganges it is कोड़णी *korni*, or in South-West Shahabad छेजनी *chhejni*. In the month of *Asārh* (June-July) sugar-cane gets a special hoeing, which is called असाही कोर *asāhi kor*, and in Champāran and North-East Tirhut टोकब *tokab*. In Gaya it is called पासा *pāsa*, and in Patna असाही कोड़न *asāhi koran*. In Champāran and the south-east it is अद्रा कोरन *adra koran*, and elsewhere it has no special name. The first hoeing of the sugar-cane crop, which generally takes place in Māgh (January-February), is called अँधेरी कोरन *andheri koran* in Patna, चाखन *chālan* or उजलन *ujhlan* in Gaya and to the west, अँधेरी *andheri* or जाड़णी *jhāri* in Saran and South Munger, and जुरनी *jhurni* in South Bhagalpur. North of the Ganges it has no special name.

CHAPTER III.—WEEDING.

867. Weeding is केरौनी *kerāuni* or कामेनी *kamaini* north of the Ganges. In the west generally it is सोहनी *sohni*. Elsewhere it is generally कोड़णी *korni*, and also हारखी *harkhi* in Patna and उजलन *ujhlan* in Gaya and Shahabad. In South Bhagalpur it is optionally केलौनी *kelauni*, and केरौनी *kerāuni* reappears again in South Munger. To weed deep is भर खुरपी सोहब *bhar khurpi sohab*; also कोड़ देब *kor deb* to the north-west and in North-West Tirhut, and कामख *khābhal* in Saran and Champāran. In Patna the operation is called बिसमादी *bismādi*, and elsewhere it has no special name. Superficial weeding is खुरपियाना *khurpiyāna* in the north-west and निकवान *nikāwan* in the south-east. In Champāran and Tirhut it is called टिपनी *tipni*. The digging up a field to clear it of weeds before ploughing is तामब *tāmb*, also in North-East Tirhut टोकब *tokab*. The operation is called तमनी *tamni*, or in North-East Tirhut टोकनी *tokni*.

Weeding by hand is चिखुरनी *chikhurni* in the north-west and उच्छतनी *uchhtani* in Champaran and Tirhut. In Patna, Gaya, and South Munger it is हाँथ से निकाल *hānth seh nikāēb*, and in South Bhagalpur थकुररी *thakurāi*. In Shahabad it has no special name.

868. Weeds are घास *ghās* or घास पत *ghās pāt*. In the north-west they are also दूध दाँदर *dūbh dāndar*, and in Tirhut दू धा. When collected and burnt as manure, they are खादर *khādar* in the north-west, and गोसा *goa* there and in Tirhut. In Patna and Gaya these are अलाह *alāh* or दाही *dāhi*, हारा *hāra* in South Munger, and चारो *chhāro* in South Bhagalpur.

869. Wages for weeding are सोहार *sohāi* or चिखुरार *chikhurāi* in north-west, and in the east generally simply बन *ban*. In Patna and Gaya they are निकौनी *nikāuni*, in South-West Shahabad बनी *bani*, and to the west generally बनिचारी *banichāri*.

SUBDIVISION V.

WATCHING CROPS.

870. Watching of crops is generally रक्खारी *rakhwāri*, अगोरी *agori*, or अगोरिया *agoriya*. Other terms are रक्खारी *rakhwāhi* or बलरक्खी *balrakkhi* in Patna, जग्वारी *jagwāri* or बध्वाहा *badhwāha* in Gaya, बध्वार *badhwār* in East Tirhut, and जोगार *jogāeb* in Champaran and South Bhagalpur. In Champaran and the south-east हाँकी *hānki* is to drive crows off a field. Elsewhere it is कौसा हाँक *kāsa hānkab*, &c. A field-watchman is रक्खार *rakhwār*, अगोरिया *agoriya*, or अगोरनिहार *agornihār*; also बलरक्खा *balrakkha* in Patna, अगोरा *agora* there and in Champaran and South Munger, जग्वरिया *jagwariya* in Gaya, and जोगनिवाँ *joganiyān* in South Bhagalpur. The बध्वार *badhwār* or बध्वाहा *badhwāha* is generally a man appointed to watch the fields of a number of cultivators and paid by the landlord.

871. In the north-west चँकनिहार *chhenknihār*, and in North-East Tirhut चकलेदा *chakledār*, is a man appointed to watch on behalf of the landlord to see that none of the crops is carried away before the demand is paid. Elsewhere he is simply called पिदादा *piyāda* or बरपिदा *barpīdā*, but to the south-east he is सिरमान *sirmān* or बलरक्खा *balrakkha*. To attach the crops thus is called रोक *roka*: hence the

Anglo-Indian phrase "to roke crops." The act of "roking" is called in the north-west चापा *chhāpa*.

872. When cultivators club together to watch their crops in turn, it is called north of the Ganges पारी *pāri*, बाँज *bhānj*, or बाँजा *bhānja*. It is also पट्टी *patti* in Patna, Gaya, and the west; also परिहार *parihar* in Patna and Gaya, पेठी *peṭhi* in South-West Shahabad, and पाठ *pāṭh* in South Munger.

SUBDIVISION VI.

REAPING AND GLEANING.

CHAPTER I.—REAPING.

873. Reaping is काटनी *katni*, or to the north-west कटिया *katiya*. In South-West Shahabad it is लौनी *launi*. To reap is काटव *kātab*, or in South-West Shahabad लौनी करव *launi karal*. To cut cane is सोल *sholal* in the north-west, गेंडा करव *genra karal* to the west, पारव *parav* in Champāran and Patna and Gaya and South Munger, and घूर काटव *ghūr kātab* in South Bhagalpur.

874. The man who cuts the cane is described in section 292. A reaper is काटनिहार *katnihār* north of the Ganges and in Patna and to the south-west. He is also दिनहार *dinihar* in Patna, Gaya, and South Munger, लेनिहार *leonihār* or कटनिवाँ *katniyān* to the west. Elsewhere he is simply जन *jan*, बनिहार *banihār*, &c. Harvest time is काटनी *katni*. The wages of harvesting are दिनौरा *dinaura* in Patna and Gaya, and दीनी *dīni* in Champāran, Gaya, and the south-east. Another name is in Gaya गुदारा *gudāra*, or in Sāran गुदर *gudār*. Elsewhere they are बन *ban*, or in South-West Shahabad बनी *bani*.

875. Cutting the ears without the stalks is बलकट *balakat* generally. Other names are तुंगनी *tungni* north of the Ganges and to the west, अगला *agla* in Champāran and Gaya, कटु *katui* in South-West Shahabad, पंगल *pāngal* to the west, and ननकटनी *nanhkatni* in South Munger. So also in East Tirhut it is ननकटनी *nankatni* or (also in Champāran) सिक्कटनी *sikatni*, and in South-East Tirhut चिपकटा *chhipkatta*. It is अगला *agra* in South Bhagalpur. Cutting crops at the root is जर्चहोर्नी *jarchhorni*, (in South-East Tirhut) जर्कटा *jarkatta*, or (in South Munger) जर्चहोरा *jarchhora*.

876. To shake the fruit off a tree is *झरझराएण* *jhārjharāēl* in the north-west. In Champāran and West Tirhut it is *झरन्नाएण* *jharkhāēb*, and in East Tirhut *झकाएण* *jhakāēb*. To the west it is *झोरल* *jhoral*, and also, generally, *झोलब* *dolab* or *झोहाब देब* *dolāy deb*. *झटाहब* *jhatahab* is to knock down fruit from a tree by throwing up sticks into it (see § 41).

CHAPTER II.—CUTTING OF UNRIPE CROPS.

877. Unripe crops are sometimes cut for food. North of the Ganges this is known as *गदरा* *gadra* or *कच्चा* *kachcha*. Other names are *गदा* *gāda* and *गदा* *gadda*. In South Munger it is *गदर* *gādar*, and in South Bhagalpur *अंकुरी* *ankuri*. The last two are also met with in Champāran. A word used to the east generally is *कचरी* *kachri*. In the north-west *समहत* *samahut* is a little grain cut first, and this is *सुमुत* *sumut* in North-West Tirhut, *नेवान* *newān* in Saran, and *नेबाब* *nebān* in Champāran and Tirhut. *झोरन्ना* *horha* is unripe grain cut for parohing. It is also called *झोरन्ना* *orha* in Tirhut and the south-east, and optionally *झोलन्ना* *holha* in Champāran and South Munger. The green ears of *Eleusine coracana* (*महुआ* *marua*) treated in this way are called *उम्मी* *ummi* or *उमी* *ūmi* to the west and in Tirhut and *अनी* *āni* in Champāran. *आलो* *ālo* in Gaya is the part of the crop which is reaped by a cultivator for present eating before the whole is ripe. Sometimes unripe pulses and barley are rooted up and given as fodder to cattle. This is called in Saran *रखान* *rakhānt*.

CHAPTER III.—GLEANNING.

878. A gleaner is *बिन्ननिहार* *binnihār* or *बिनिर्घा* *biniyān* to the west. He is also generally *झोडनिहार* *lorhnihār*, with variants *झोडन्नाहार* *lorhtāhar* in Patna, Gaya, and South Munger, and *झोरन्ना* *lohra* in South Bhagalpur. Gleanings left on the field for the lower orders are *झरंगा* *jhānga* or *झारंग* *jhārang* to the west, and *झोही* *lorhi* or *झोहीया* *lorhiya* to the east and in Champāran. Other names are *झरुआ* *jharua* (Patna and North-West Tirhut), *झर* *jhar* (South-East Tirhut), and *छटल पटल* *chhūtal patal* (Champāran and Tirhut). Gleaning is called in Gaya and South Munger *झोहा बिच्चा* *lorha bichcha*, and gleanings are *झोहा* *lorha*.

SUBDIVISION VII.

THRESHING AND WINNOWING.

CHAPTER I.—THE THRESHING-FLOOR.

879. A threshing-floor is everywhere खरिहान *kharihān*, with an optional variant खरिहानी *kharihāni* in Patna. The shed erected on the threshing-floor is मरुई *marai*, खोंपड़ी *khompri*, or खोंपड़ी *jhompri*. In Patna it is मरुका *maruka* or खोंपड़ा *jhompra*, in Gaya कुरा *kurha*, and in the south-east खोंपड़ा *khompra*.

CHAPTER II.—SHEAVES AND BUNDLES.

880. The cut crop is दंत *dānth* to the north-west, or दंत *dānt* in North-West Tirhut. In East Tirhut it is लार *lār*. In Shahabad it is लेहनी *lehni*, in Champāran लेहन *lehan*, in Gaya पतौर *pataur*, in Patna पतौड़ी *patauri* or पतनी *patni*, in South Munger पतान *pātan*, and in South Bhagalpur पतन *pattan*. In Shahabad it is called पलहारी *palhāri*, and in Sāran पथारी *pathāri*, when it is left a day in the field without being gathered.

881. In considering the nomenclature of the sheaves it will be convenient to take North and South Bihār separately.

NORTH BIHAR.

882. The smallest sheaf, about a handful, is called मुठा *mūtha*, मुठा *muttha*, or पूठा *pūla*; the next largest is the अंबांसा *ambānsa* (north-west), ओल्हा *aulha* (North Tirhut), and आडल *āhul* or अडला *ahula* (East Tirhut); the next largest is the अंठिया *antiya* or (Champāran and North-West Tirhut) पसही *pasahi*; the next largest is an armful or पांजा *pānja*; the next largest is a बोजा *bojha*; and the largest of all, that carried on a bullock, लदना *ladna*. The relative scale of some of the above is generally as follows:—

| | |
|----------------------|--|
| 4 मुठा <i>mūtha</i> | = 1 अंबांसा <i>ambānsa</i> or ओल्हा <i>aulha</i> . |
| 8 ओल्हा <i>aulha</i> | = 1 पांजा <i>pānja</i> . |
| 4 पांजा <i>pānja</i> | = 1 बोजा <i>bojha</i> . |
| 16 बोजा <i>bojha</i> | = 1 सोरही <i>sorhi</i> . |

In East Tirhut the following scale obtains :—

| | |
|-----------------------|---------------------------|
| 4 धाडस <i>dhul</i> | = 1 केहनी <i>kehuni</i> . |
| 4 केहनी <i>kehuni</i> | = 1 पाँजा <i>pānja</i> . |
| 4 पाँजा <i>pānja</i> | = 1 बोभा <i>bojha</i> . |
| 16 बोभा <i>bojha</i> | = 1 चोरही <i>sorhi</i> . |
| 16 चोरही <i>sorhi</i> | = 1 चोरहा <i>sorha</i> . |

883. The word चोरही *sorhi* is a common unit for measuring produce. Thus, a *raiyat* will say that such and such a field gives so many चोरही *sorhi* to the *bigha*.

SOUTH BIHAR.

884. The proportions vary in different places, as follows :—

SOUTH-WEST SHAHABAD.

| | |
|--|--|
| 2 अँवाँही <i>anwānsi</i> | = 1 अँडिया <i>antiya</i> or होमगुा <i>domra</i> . |
| 10 ditto | = 1 पाँजा <i>pānja</i> , पूरी <i>pūri</i> , or चाँडी <i>ānti</i> . |
| 3 पाँजा <i>pānja</i> , पूरी <i>pūri</i> , or चाँडी <i>ānti</i> | = 1 बोभा <i>bojha</i> . |
| 30 ditto ditto | = 1 तिसौर <i>tisaur</i> . |

SHAHABAD.

| | |
|---------------------------|--|
| 10 अँवाँही <i>anwānsi</i> | = 1 अँडिया <i>antiya</i> or पनपिचौवा <i>panpiaua</i> . |
| 4 अँडिया <i>antiya</i> | = 1 बोभा <i>bojha</i> . |
| Or 10 चाँडी <i>ānsi</i> | = 1 पाँजा <i>pānja</i> . |
| 4 पाँजा <i>pānja</i> | = 1 बोभा <i>bojha</i> . |
| 21 बोभा <i>bojha</i> | = 1 एकैसिया <i>ekaisiya</i> . |

PATNA.

| | |
|------------------------|---------------------------|
| 4 अरगुा <i>arpa</i> | = 1 चाँडी <i>ānti</i> . |
| 5 चाँडी <i>ānti</i> | = 1 गाही <i>gāhi</i> . |
| 5 गाही <i>gāhi</i> | = 1 बोभा <i>bojha</i> . |
| Or 5 अरगुा <i>arpa</i> | = 1 पाँजा <i>pānja</i> . |
| 5 पाँजा <i>pānja</i> | = 1 बोभा <i>bojha</i> . |
| 21 बोभा <i>bojha</i> | = 1 एकैसी <i>ekaisi</i> . |

GAYA.

| | |
|-----------------------|-----------------------------|
| 3 चरपा <i>arpa</i> | = 1 चाँटी <i>anti</i> . |
| 5 चाँटी <i>anti</i> | = 1 गापी <i>gāhi</i> . |
| 10 गापी <i>gāhi</i> | = 1 बोजा <i>bojha</i> . |
| Or 9 चरपा <i>arpa</i> | = 1 पाँजा <i>pānja</i> . |
| 3 पाँजा <i>pānja</i> | = 1 बोजा <i>bojha</i> . |
| 21 बोजा <i>bojha</i> | = 1 प्रकैसी <i>ekaisi</i> . |

SOUTH MUNGER.

The same as Gaya, except that 4 पाँजा *pānja* = 1 बोजा *bojha*.

SOUTH BHAGALPUR.

| | |
|----------------------|----------------------------|
| 4 गौली <i>gaunti</i> | = 1 चाँटी <i>anti</i> . |
| 4 चाँटी <i>anti</i> | = 1 पाँजौ <i>pānjau</i> . |
| 16 चाँटी <i>anti</i> | = 1 बोजा <i>bojha</i> . |
| 16 बोजा <i>bojha</i> | = 1 चोरन्ही <i>sorhi</i> . |

885. The word प्रकैसी *ekaisi* south of the Ganges is used in much the same way that चोरन्ही *sorhi* is used; so also तिसौर *tisaur*. It will be seen that the above scales are not always consistent amongst themselves. This is the fact, and is due to a difference in the size of the unit according to locality. The बोजा *bojha* is about the same everywhere.

886. An अकवार *akwār* or अँकवार *ankwār* (optionally), or in Patna and South-East Tirhut केहुनी *kehuni*, is as much grain as can be carried between the arms, and मथबोजा *mathbojha* is a load carried on the head. Out of each बोजा *bojha* one चाँटी *anti* is given to the labourer who cuts and carries away the crop, and the remainder is in Shahabad called गुदर *gudār*.* गुच्छ *gund* in Patna or गूँडा *gūnda* in Gaya is a bundle of cut pulse.

CHAPTER III.—TREADING OUT GRAIN.

887. Treading out grain is दौनी *dauni* north of the Ganges. To the west and in Patna it is also दौरी *daunri* or मिन्यनी *minjni*. The latter word is principally used when the grain is trodden out by men and not

*The चाँटी *anti* given to, or rather taken by, the reaper varies in size, as is witnessed by the proverb कोढ़ि कटनिहार केँ छपर सन चाँटी *korhi katnihār keṅ ṣapar san anti*,—the lazy reaper gets a bundle as thick as a club.

by bullocks. In Shahabad it is *दौरी dauri*, and so also in the south-east. In Champāran, Patna, Gaya, and South Munger it is *दावाँची dāwānhi*, and in Patna also (when trodden by men) *मैजनी mainjni*. In South Bhagalpur *सहरी sahari* is a thorough threshing of corn. The beating out of the heads against the ground or bed to disengage any grains that remain is *पीटव pitab*, *झारव jhārab*, or *झाँटव jhāntab* north of the Ganges. It is also *पेटारी petāri* to the west, *डंगौनी dangauni* in Patna, *पिटनी pitni* in Champāran and Gaya, *डंगौनी dengauni* in East Tirhut and South Munger, and *झंटनी jhantni* in South Bhagalpur.

888. The first treading out of the grain is called *पौर paur*; the second treading is *दाली दाँव danti dānwab* north of the Ganges and in Shahabad, or *तोड़ाव torāeb* in North-East Tirhut. To the west it is *झाँटव chhāntab*, in Champāran and Patna it is *खुरदाँवी khurdauni*, in Gaya *खुरदाँती khurdanti*, and in South-East Tirhut and South Munger *खुरदाँई khurdāin*.

889. The stake to which the bullocks are tied in treading out the grain is *मैह meih*, with local variants *मैहा meūha* (to the north-west and in South-East Tirhut), *मेहडा mehta* (Patna), and *मीहाँ mīhān* (South Bhagalpur). In South-West Shahabad no centre stake is used. A bullock stands in the centre, who is called *मैहियाँ बैह meñhiyān bail*. In other places the inner bullock next the post, which is the slowest and weakest of the team, is called *मैहियाँ menhiyān* generally; also *मैहा menrha* in Champāran and South-East Tirhut, and *मेहडा mehta* or *मैहडा menhta* in Gaya and South Munger. In South Munger he is also *मेहा meha*, and in South Bhagalpur *मीहाँ mīhān*. Another name for him is in Gaya *कुर्दाहिना kurdahina*. The outer bullock, which is the smartest of the team, is called *पाठ pāth* or *पठिया pathiya* to the west, to the north-west and in North-West Tirhut *पठिया patiya*, and in East Tirhut *पाठ वाला pāt wāla*. In South-East Tirhut it is *अगदाँ agdāen*, and variants of this are *अगदाँ agdāin* in Patna and South Munger, *अगदाँर agdāin* or *अगदाँरियाँ agdāinyān* in Gaya, and *अगदाँर agdāin* in South Bhagalpur. In South-West Tirhut he is *पेरा phera*. The rope which goes round a bullock's neck is *गरदाँव gardānw* in the west and in South Munger, *गरदाँनी gardani* in Champāran and West Tirhut, and *गराँधा garaundha* in Patna. The main rope to which all the bullocks are tied is *मज्जा manjha*, also *दौरी daunri* to the west, *दौरु daunrar* or *दोग्घा dogha* in West Tirhut, and *कराम karām* in East Tirhut. In Patna, Gaya, and South Munger it is *दावाँची dāwānhi*, and in South Bhagalpur *दाँवर dāmmar*. In

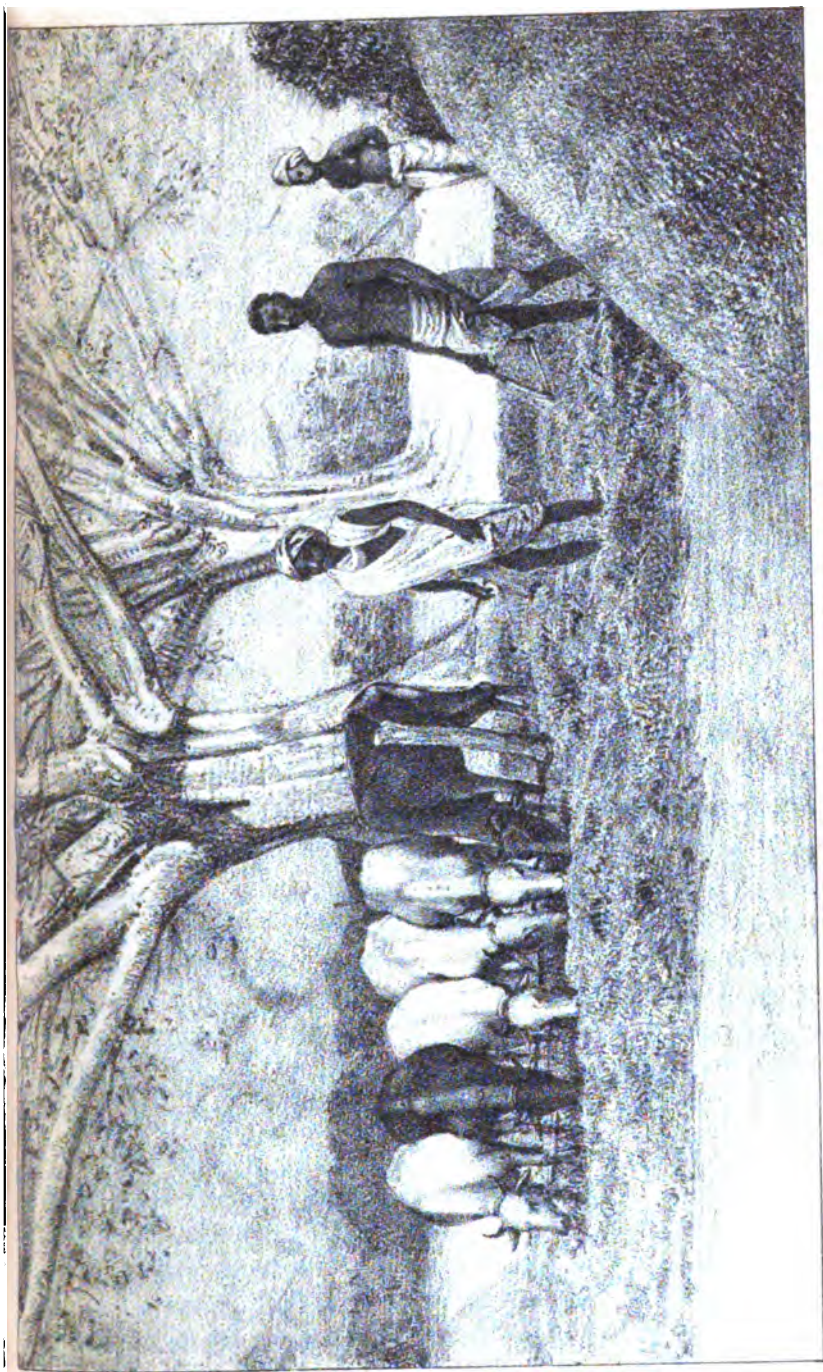

*A threshing floor (kharikān) The man standing on the right of the picture holds in his right hand
a threshing-ribe (akhuina)*

Lith. by Harilal Pal Student Govt. School of Art Calcutta.

Cornwallis Press Calcutta.



Champāran and Gaya it is also called कौड़ *kānr* or कौड़ा *kānra*. The rope by which the main rope is tied to the stake is घुरी *ghūri* or मेहौड़ी *meñhauti* in Patna and Gaya, and डौड़ा *donra* in South Bhagalpur.

CHAPTER IV.—CROPS ON THE THRESHING-FLOOR.

890. *The pile of sheaves.*—When the crop is piled in bundles on the threshing-floor it is known as गौंज *gānj*. Other names are टाल *tal* (north of the Ganges and Shahabad), गाला *galla* (North-West Bihar), डेरी *dheri* in Gaya, and कौड़ *kānr* or कौड़ा *kānra* in Champāran and to the east; also खम्हार *khamhār* in South-East Tirhut. When the cut crop is piled like a stack in England, with the grain heads inside to save them from rain, it is called कोठिया *kothiyau* in Saran, and पूंज *pānj* or पुंजौर *punjaur* to the north-west and in Patna, Gaya, and the south-east. When *rahar* (*cytius cajan*) is piled on end to ripen before threshing, it is called खरा टाल *khara tal* north of the Ganges. Stacks are rarely raised on platforms in Bihār, but when it is done the platform is called मचान *machān*.

891. *The spread-out crop.*—When the crop is spread out flat on the threshing-floor, ready to be trodden out by the bullocks, it is पैर *pair* north of the Ganges and in Shahabad. Other names are पौर *paur* or पौरी *pauri* in East Tirhut, खोर *khoh* in Champāran and South East Tirhut, बड़बोरा *barhora* in Patna and Gaya, बड़बारा *barhara* in South Munger, and खूआ *khūa* in South Bhagalpur.

892. *The crop after it is trodden.*—After the crop is trodden out the pile of chaff and grain ready for winnowing is सिल्ली *silli* north of the Ganges, in Patna, and the south-west. Other names are कुटाँव *kutānw* (Patna and North-West Bihar), डेरी *dheri* in Champāran, Tirhut, and South Munger, पैर *pair* in Champāran and Gaya, and धार *dhar* in South Bhagalpur. In South-East Tirhut it is also उकाम *ukām* (also in Patna) or उकुम *ukum*, and in Shahabad उकाँव *ukāñw*.

893. *The heaped grain.*—This is रास *rās* or डेरी *dheri*, also in North-East Tirhut खोर *khoh*. Over this is placed a cake of cowdung to avert the evil eye. This is बड़ाँव *barhānw* (Patna and West Bihar) and बड़बावन *barhāwan* in Gaya and the west; but बड़ाँव *barhānw* is more properly the dung deposited by the bullocks while treading. Other names for the cake are महादे *mahāde* or महादेव *mahādeb*. A

piece of moist earth stamped is sometimes used in the same way, and is called चाकल *chākal* to the west and चप्पा *chappa* generally. In South-East Tirhut a piece of wood so used is called जाक *jak*.

894. *The heaped straw and chaff.*—Straw in bundles is पूजा *pūja* in Patna and north of the Ganges, except in North-East Tirhut, where it is जहवा *jhatua*. South of the Ganges, and optionally in Sāran, it is चाँटी *ānti* or चाँटिया *antiya*, except in the south-east, where it is पुजा *pulla* or बिँडा *biṅra*. Loose straw that has been threshed is पुवरा *puara* (to the west) or पुवार *puār* (to the east). Local variants are पोर *pora* (also in West Tirhut) or पोवार *poār* in Patna and South Munger. When it has not been threshed, but has been left standing in the field after the ears are cut off, and then itself cut, it is called नार *nār*, and also (to the east) लार *lār*. Its stalks are whole, and are not crushed like threshed straw. नेवारी *newāri* is straw which is cut with the ear, but is not trodden by bullocks. It is tied up in bundles, and the heads are beaten against the ground. The husks of the grains are हसा *bhūsa* or हसुआ *bhusea*. South of the Ganges a nasal is generally inserted—thus, हूँसा *bhūṅsa*. Other names are कटुवा *katua* in Patna and Gaya, गुंडो *gundo* in Champāran and South Bhagalpur, and खखरा *khakhra* or दुवा *dhulla* in South Munger. Bran is चोकर *chokar*, also in Patna and the west हूँसी *bhūnsi*. Other names are चहौँसी *chalaunsi* (Patna and the west), कोरार *korār* (Patna, Tirhut, and the west), चोकर *chonkar* in Champāran and Patna, and चोकरा *chokra* in South Munger. The heaped straw on the threshing-floor, or a stack of straw anywhere, is गँज *gānj* or टाल *tāl*. सिल्ली *silli* is also specially used for the heap of straw on the floor.

895. An enclosure for stacking straw or fuel is घेरान *gherān* in West Tirhut, Sāran, and Champāran, घोरा *ghorān* in Shahabad, and घेरा *ghera* or डाढ *dhāth* in Champāran and Tirhut, the latter specially to the east. To the west it is पुरवाट *purwat*. A house for holding chaff is हसौल घर *bhusaul ghar* in the north-west and West Tirhut, and हसुकार *bhuskār*, हसुसहलबा *bhussbhulba*,* or (also in Champāran) हसुखार *bhuskhār* to the east. In South-West Shahabad it is हंसौर *bhunsaur*, and to the west generally of that district हंसुहल *bhuṅsāhul*. In Champāran and Patna it is भौँसीला

* As in the proverb हूँसुल घोड़ हसुसहलबासिं डाढ *chhūtal ghor bhussbhulbasiṅ dhāth*,—a horse, when he gets loose, stays in the chaff-house.



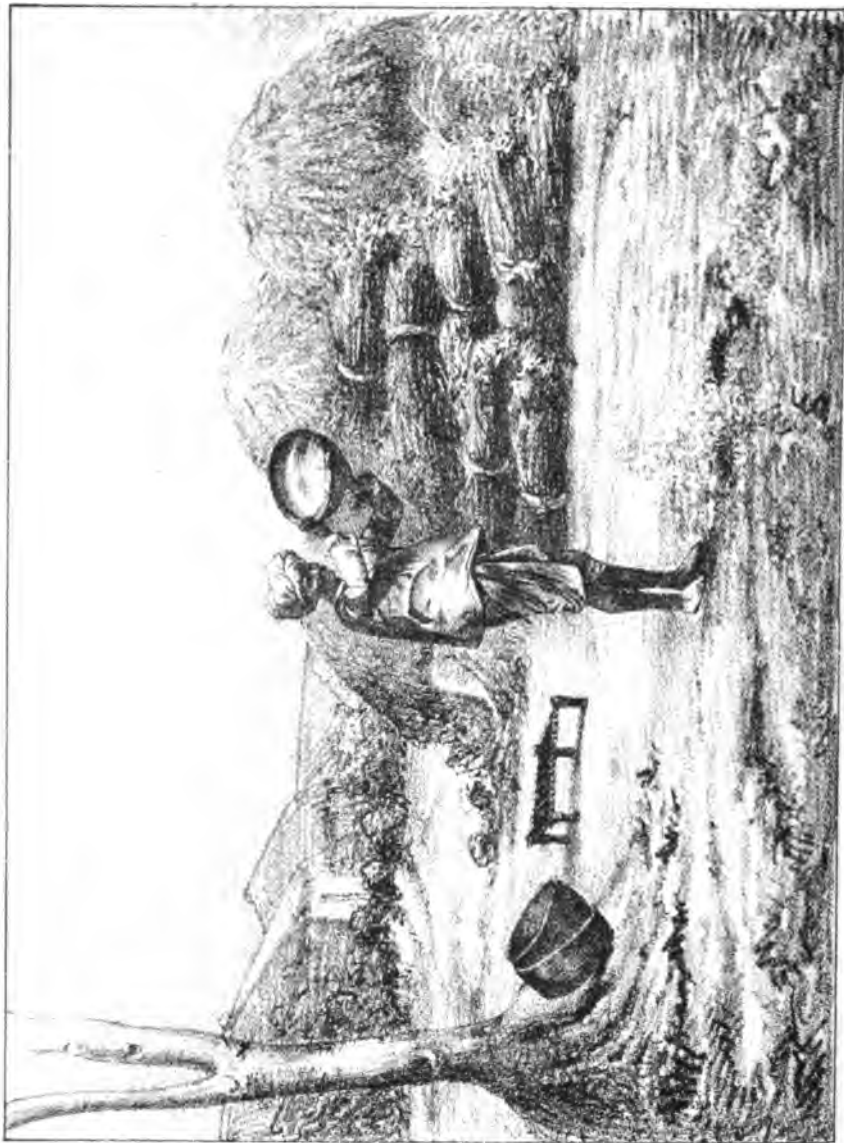

WINNOWING (OSAUNI)

With Mr. H. S. Choudhury, Choral, Westport (Ivory) School of Arts, Calcutta.

W. Newman & Co. Limited, Calcutta, India.

bhōṣaula, and there and in Gaya *बूसा घर bhūsa ghar*. In Champāran and South Munger it is *बुसघर bhūsgar*, and in South Bhagalpur *बुसकारी bhuskāri*. *बोंप khomp* or *बोंपी khompi* north of the Ganges is a small shed for chaff. The round thatch covering a *बोंप khomp* to save it from the weather is *बोंप के मथनी khomp ke mathni*, *चापनी chhāoni*, or *टोपड़ topar*. In South-East Tirhut *चांग chāng* is a large basket for holding chaff equalling four *टोकरी tokri*. *तंगौर tangaur* in the same place is a similar one, but is rougher and made of *rahar (Cytisus cajan)*.

896. *The refuse straw and fodder.*—This is in the north-west *गोथार gothār*, to the west and in North-West Tirhut it is *लथेर lather*, in Champāran and North-East Tirhut *निघास nighās*, and South-East Tirhut *निघेस nighes*. South of the Ganges and in Champāran it is *दाँटी dānti*. The refuse straw of the *rabi* or spring-crop, and specially of the *rahar (Cytisus cajan)*, is *ररेठा raretha* generally south of the Ganges, local variants being *लरेठा laretha* in South Bhagalpur, and in Champāran *रहेठा rahetha*. In Patna it is also called *खरई kharāi*. The refuse straw of the autumn crop is *दाँठ dānth* or *दँडका dāntuka* or *कुटका kutka* north of the Ganges. It is also to the west and in Patna *धड़ा dhattha*, and elsewhere *दाँठ dānt*, *दाँटा dānta*, or *दाँटी dānti*. In South Bhagalpur and Patna, however, it is *ठठेरो thathero*. The dry stalks of mustard (*सरिसो sariso*) are *सथी santhi* in the north-west, *तिलथी tilthi* to the west and in North-West Tirhut, *तोरियाठी toriyāthi* in South-West Tirhut, *तोरियठ toriyath* in Shahabad, and *तिलाठी tilāthi* generally. The stalks of cereals without the ear are *जंगना jhengra* to the west and in South-West Tirhut, *जहेगा jhega* in Champāran, *दाँठ dānt* in the rest of Tirhut, *जङ्गा jhanga* in Champāran, and *चांग chāng* also in South-East Tirhut.

CHAPTER V.—WINNOWER.

897. *Winnower grain is ओसानी oṣāni*. To winnow is *ओसाएव oṣāēb*.

898. The fine chaff which is blown away by the wind in winnowing is *पम्बी pambhi* generally; also *पंकी pānki* or *पंजी pāmbhi* to the west, *गुन्री gūnri* in Champāran and South-East Bihar, and *भाउन्ता bhaunta* in Patna. South of the Ganges these words are confined to the winter (*Aghani*) crop. The words for the autumn (*Bhadōi*)

crop are पुरेसी *pureśi* or पुसरन्धी *puarā* to the west, and पखनी *pakhni* in Patna and Gaya. In South Munger अधभरी *adhbhari* is rice not fully developed, in which the ear is only half full, the rest being all chaff.

CHAPTER VI.—MISCELLANEOUS.

899. The gathering or collecting grain at one place in the time of harvest is बटोरन *batoran* or डोहन *lorhan*.

900. When grain is being weighed, an extra handful is thrown in to make up for dust, &c. This is called पक्षुवा *pachhua* generally, but also कसर *kasar* to the west and फान *phāo* in the south-east. It is also called लह *lah* in Champāran and South Munger.

901. The grain left on the threshing-floor after removing the bulk of the crop is अग्वार *agwār* generally north of the Ganges, and भाह *bhāth* in South-East Tirhut. South of the Ganges and in Sāran it is तारी *tari*. The gleanings and refuse grain on the threshing-floor are पटपर *patpar* in the north-west and खखरा *khakhra* to the west and north. The grain which is blown away with the chaff at the time of winnowing is अग्वार *agwār* or अग्वारी *agwāri* to the west, अगार *agar* in Champāran, Patna, and Gaya, and अग्वार *agbar* in the south-east.

SUBDIVISION VIII.

DIVISION OF CROPS.

CHAPTER I.—DIVISION AND VALUATION.

902. The division of crops on the *metayer* system between landlord and tenant is called बटार *batāi* or बटैया *bataiya*. Local variants are बान्त *bānt* in Champāran and Gaya, बान्ती *bānti* in Champāran and South Bhagalpur, and बान्तू *bāntu* in South-West Shahabad. Land so held is called भांभली *bhāoli* or बटैया *bataiya*, as opposed to नगदी *nagdi*, of which the rent is paid in cash. In South Bhagalpur the division of the crops is called कुरनाली *kurtāli*.

903. In बटार *batāi* a certain fixed proportion of the crop is given to the landlord as rent, as described in the following chapter. When,

instead of a *proportion*, a certain fixed quantity of the crop per bigha is paid to the landlord, it is called *मन्कष* *mankhap*, *मन्ठीका* *manthika*, *हुन्दा* *hunda*, or *मन्हुन्दा* *manhunda*. This is especially adopted in the case of *जिरात* *jirat* or home-farm lands when let to a cultivator. In Patna it is called *मनी बन्दोबस्त* *mani bandobast*.

CHAPTER II.—THE SHARES INTO WHICH THE CROP IS DIVIDED.

904. *Half to landlord and half to tenant.*—This is called *अधिया* *adhiya* north of the Ganges and in the south-west, in Patna and Gaya *अधबतिया* *adhbataiya* or *पह* *pah*, in Champāran and the south-east *अधबतिया* *adhbatiya*. In South-West Shahabad they say *दू दाना में से एक दाना जमिंदार देवला, चाउर एक दाना बरानी के देवला* *dū dāna meñ señ ek dāna jamidār lehala, āur ek dāna asāmi ke dehala*,—of two grains, the landlord takes one and gives one to the cultivator. The turn of the sentence which makes the landlord *give* the cultivator his share is worth noting.

905. *Seven-sixteenths to landlord and nine-sixteenths to the tenant.*—This is *नौसत* *nausat* or *नौसता* *nausatta*. The practice has only been noted in the west, Patna, Gaya, and South Munger. In South-East Tirhut the custom is only observed in respect to mangoes and jack-fruit.

906. *Nine-sixteenths to the landlord and seven-sixteenths to the tenant.*—This is *नौसता* *nausatta*. The practice has only been noted to the west and in Patna, Gaya, and South Munger; also (*सेरी नौसता* *seri nausatta*) in West Tirhut.

907. *One-third to the landlord and two-thirds to the tenant.*—This is *तेकुरी* *tekuri* or *तिहैया* *tihaiya* in Shahabad, Patna, and Gaya, *तेकुरा* *tekura* in South-West Shahabad, *तेखुरी* *tekhuri* in South Bhagalpur, *तेकुली* *tekuli* in Champāran, *तिसरी* *tisri* in Saran and Champāran, and *तेसरी* *tesri* in South Munger. Not noted elsewhere.

908. *Two-fifths to the landlord and three-fifths to the tenant.*—This is *पचदू* *pachdu* to the west and in West Tirhut, *पचा दूचा* *pachcha dūa* in Patna, Gaya, and the south-east, and *पंचदू* *panchdu* to the west. Not noted elsewhere.

909. *Three-fifths to the landlord and two-fifths to the tenant.*—This is *पचदू* *pachdu* to the north-west, and *पंचा दूचा* *pancha dūa* in South Munger and Tirhut. Not noted elsewhere.

910. *Landlord one-fourth, tenant three-fourths.*—This is चौडेवा *chauthaiya* in Champaran and South-East Tirhut and चौडेवा *chauthaiya* to the west and in Patna and Gaya. Not noted elsewhere.

911. The following remarks as to custom south of the Ganges may be of use. The division into equal shares is rare, and is confined to the cases of high-caste tenants, or where a tenant has obtained a decree of the Civil Court restricting the landlord's share to one-half. Nine-sixteenths to the landlord and seven-sixteenths to the tenant is the customary rate, the two-sixteenths in excess which are claimed by the landlord being supposed to represent the cost of collection, irrigation, and watching the crops. When the landlord takes less than a half-share of the crop, as in §§ 905, 907, 908, and 910, it is only in exceptional cases, as in time of drought, or when a jungle or waste land has to be brought under cultivation, or when land requires much labour on the part of the tenant. In these cases the settlement is always for a limited period, say one, two, or three years, and is often on a progressive scale, *i.e.*, in the first year the landlord takes one-fourth, in the second year one-third, in the third year two-fifths, and thereafter half of the gross produce. When the landlord takes three-fifths and the tenant two-fifths (§ 909), it is a case of special agreement with a landlord, who lets his private (खुद काबज *khud kāsht*) lands. In calculating all these shares (except in the case of division by bundles, see § 913) only the net grain produce after threshing is divided. The tenant in addition takes all the straw.

CHAPTER III.—DEDUCTIONS AND REMISSIONS.

912. A deduction of one *ser* in the maund from the amount received by the tenant is called सुपही *supahi* to the west, and also सेरही *serhi* in Shahabad. A similar deduction of $1\frac{1}{4}$ *ser*s per maund is called in South Bhagalpur नेत्र *neg*, or perquisite. In the case of division by appraisement (see next chapter) an allowance is made for deficient produce. This is called to the west and in Tirhut छुट *chhut*. South of the Ganges and in Champaran it is called गरकी *garki*, also नाबूद *nābūd* in Patna, छुटती *chhutti* in Gaya, गरकी परती *garki parti* in South Munger, and गरकी गरकी *marki garki* in South Bhagalpur. A similar deduction of $1\frac{1}{4}$ *ser*s in the maund is called in Champaran, Patna, and Gaya डेरसेरी *derhseri*; and when of two *ser*s, दुसेरी *duseri*. To the west दहार महार *dahār mahār* is the loss to both landlord and

tenant when the produce is deficient through inundation. A remission to a high-caste tenant is called पगरी *pagri* or माफी *māphi*. North of the Ganges पड़ुषा *paohhua* is an allowance made by the tenant for dust in the landlord's share of the grain. In Sāran and Patna अँजुरी *anjuri*, and in Shahabad अँजुर *anjur*, is an allowance of one or two *ser*s per plough taken by the tenant. खलिहानी *khalihāni* in Patna is an allowance claimed by the tenant, and so also is भँवर *bhāmwar* in Shahabad and मँगनी *mangni* or मँगन *māngan* ($\frac{1}{2}$ a *ser* in the maund) in East Munger.

CHAPTER IV.—MODE OF DIVISION.

913. This may be considered under two heads,—division on the field and division on the threshing-floor.

Division on the field.—This may be done either by actual division of the bundles (बोजा *bojha*) or by appraising (कनब *kanab*) the value of the crop. When the bundles of the cut crop are divided, this is called बोजबटार *bojhbatai* or (in Champāran and South-East Tirhut) खरबटार *kharbatāi*. To the north-west it is जजानी बटार *jajāti batāi*. The rough appraisement of the crops for the purpose of division is called कन *kan* or कूत *kūt*, or कनकूत *kankūt* or कनकूती *kankutti*. When the valuation is done by appraisement it is called कनकूती बटार *kankutti batāi*. It is also called दानाबन्दी *dānābandi* generally, भौकटा *bhaukatta* in Shahabad and the south-east, दमाब *damāo* or दमकट्टी *damkatti* in Shahabad, Patna, and Gaya. When the crops are ripe for harvesting the landlord deposes an assessor (अमीन *amin*) and an arbitrator (सलिस *salis*) to the field. They are met there by the tenant and the village officials. The village measurer (कडाधर *kathādhar*) then measures the field with the local pole, and the arbitrator goes round it, and after a consultation with the assessor and the village officials estimates the quantity of grain in the field. If the tenant accepts the estimate, the quantity is entered in the *patwāri's* field-book (खसरा *khasra*) and the matter is at an end. If the tenant objects, his fellow tenants are called in as mediators, and if they fail to convince either party a test (परतार *partār*) takes place. On behalf of the landlord a portion of the best part of the crop is reaped, and an equal portion of the worst part is reaped on behalf of the tenant. The two portions so reaped are threshed and the grain weighed. On the quantity thus ascertained, the whole produce of the field is calculated and entered in the field-book. The tenant is

then at liberty to reap the crop and take it home whenever it suits his convenience. In calculating the amount due to the landlord from the whole estimated quantity a deduction in favour of the tenant of generally two *ser*s per maund, called **छुटती** *chhutti*, &c., (see § 912), is made to allow for deficient produce and for the cost of reaping, gathering, and threshing, which in this system of division is borne by the tenant. The remainder, thus calculated, is then divided into the respective shares of the landlord and the tenant, and the latter is debited with the landlord's share in the accounts. If he pays this amount within the year, it is paid in kind ; but if he does not do so, its value in money is written against him as an arrear in next year's accounts.

914. *Division on the threshing-floor.*—This is **बटार खरिहानी** *batāi kharihāni*, **अगोर बटार** *agor batāi* (because it is watched or guarded till division), or **बटार** *batāi* simply. The man who weighs the grain is called **हटवा** *hatwa* north of the Ganges. He is also **हटवे** *hatve* in Champāran, Patna, and Gaya, **बाबा** *bāya* or **बया** *baya* to the west, **सोनार** *sonār* in Patna, and **केवाल** *keāl* or **बनिर्वा** *baniyān* in Patna and the south-east. His fees are called **हटवारी** *hatvāi* or **हटवारी** *hatvāi* north of the Ganges, and also **पक्षुवा** *pachhua* in Champāran and Tirhut. In Champāran and East Tirhut they are also **मनपारी** *manpāi* or **मनपौवा** *manpauu*. To the west they are **बेबाद** *beyāi* or **पवही** *pawahi* ($\frac{1}{2}$ *ser* per maund), in Gaya and South Munger **चालवा** *chālsa*, in Patna and Champāran **धुरिया** *dhuriya* ($\frac{1}{2}$ *ser* per maund), and in the south-east **केवाली** *keālī* or **तौलार** *taulāi* (one *ser* per maund). When grain is measured instead of being weighed, 16 cups (**पैला** *paila*) of grain make one **आदा** *ārha*. In this system the crops are reaped under the supervision of both parties, and are gathered on a common threshing-floor (see § 879), and strictly watched by both parties. Threshing does not take place until all the crops of the village have been thus gathered. Neither party is allowed the use of the crop till the grain is threshed out, weighed, and divided. During the reaping period the tenant at the end of each day gets the gleanings of the field (**लोहा** *loḥa*, &c., see § 878), and a fixed proportion of the gross produce (**दिनौरा** *dinaura*, &c., see § 874), which go as wages to the reaper. From the joint crop the village artisans and officials (carpenter, blacksmith, shoemaker, accountant, &c., see §§1193 and ff.), who have worked all the year round for both tenants and landlords, receive their perquisites. When the heap of grain is ready for division, the grain

which is blown away with the chaff (बगडा *agër*, &c., see § 901) is not divided, but is all the property of the tenant. Out of the common heap are then set aside the dues given for religious purposes (बिसुन पिरिन *bisun pirit*, &c., see § 1203), and out of the grain thus left the landlord takes his share, but the refuse grain mixed with dust left after removing the bulk of the crop (तरी *tari*, &c., see § 901) is all taken by the tenant. In this system, too, the tenant gets all the straw, chaff, &c.

SUBDIVISION IX.

IRRIGATION.

CHAPTER I.—IRRIGATION GENERALLY.

915. To irrigate is पटाएव *patâëb*, or to the west भरल *bharal*. Irrigation is पटावन *patâvan* or पटोनी *patâuni*. In South Munger it is पटान *patân*. The flooding of a field preparatory to planting rice is डेव *leb*, डेव *leo*, or डेवा *lewa*, and in South Bhagalpur अन्हाव *anhâo*. Such a flooded field is called पनिसाएव *paniyâël*. A water-drawer is पनिसारा *panihâra* or पनभरा *panbhara*. In the north-west he is also पनभारा *panbhâra*. A man irrigating has various names. To the north-west he is पनभन्ना *panchhanna*, and in Gaya पनभन्दा *panchhanda*; in Sâran and Champâran he is पनमोरवाह *panmorwâh*; in South-West Tirhut he is खरवाहा *kharwâha*; and in South-West Shahâbad he is कम्हाया *kamhaiya*. The man who distributes the water in the field with the पत्ता *hattha* or wooden shovel (see section 64) is called हथवाहा *hathwâha* or चिरकना *chhirkana* to the north-west. In Shahâbad he is बरवाह *barwâh*; to the west generally पनिसाह *paniwâh*; in Patna and Gaya, खन्मोडा *khanmora* or चिचनियाँ *chhichaniyân*; in Patna, सिचवाहा *sinchwâha* or खन्वाहा *khanwâha*; in Champâran and South Bhagalpur, खरकटा *kharkatta*; and in South Munger, गनरकटा *ganrarkatta*. The wages for irrigation with a lever are लठवाही *lathwâhi*. Sometimes cultivators combine to assist one another in irrigating. This is called जाना *jâna* in Sâran and Champâran, पैठी *painthi* or पलठी *palti* to the west, and the latter also in Patna and Gaya, परिहर *parihar* in Patna, पतिहर *patihar* in Champâran and South Munger, and पाएव *patêt* in Champâran and South Bhagalpur.

CHAPTER II.—KINDS OF IRRIGATION.

916. There are three main kinds of irrigation :—

(a) *From canals.*—A canal is नहर *nahar* (which is generally used only for the Son and similar Government canals), पैन *pain*, or पेनि *paini*, and नद्दी *naddi* or (South Bhagalpur) लद्दी *laddi*. In South-West Shahabad a canal is ताल *tāl*.

(b) *From wells* (कुएँ *kūān*, &c.)

(c) *From tanks, or ponds.*—A tank is पोखर *pokhar*, पोखरा *pokhra*, or तलाव *talāo*.* A small pond is तलाही *talāhi*. In Patna, Gaya, and South Munger a reservoir of which the water is higher than the level of the surrounding country and is kept in by embankments is called खजाना *khājāna* or खजाना *khajāna*.

917. The embankment round all these tanks and ponds is called भौड़ *bhir* or भिन्दा *bhinda*. Local names are पीड़ *pinr* in Patna and Gaya, and खौवाँ *khāwān* or खावा *khāwa* to the west. The post erected in the centre of a tank is जाट *jāt*, जाटि *jāti*, जाठ *jāth*, or जाटि *jāthi*. In South Munger it is लाठ *lāth*.

* In North-East Tirhut पोखरि *pokhari* is a large tank, as is instanced by the proverbial saying—

पोखरि राजोखरि, खौर सब पोखरा ।
राजा सिब सिङ्ग, खौर सब पोखरा ।

*Pokhari Rajokhari, aur sabh pokhra,
Rāja Sib Singh, aur sabh chhokra.*

—“The tank at Rajokhari is indeed a tank; all the rest are puddles. Raja Sib Singh was indeed a king; all others were princelets.”

Another version of this is—

ताल तः भोपाल ताल, खौर सब तलाया ।
राजा तः सिब सिङ्ग, खौर सब राजैया ।

*Tāl ta Bhopāl tāl, aur sabh talaiya,
Rāja ta Sibai Singh, aur sabh rajaiya.*

Rajokhari and Bhopāl are the names of two villages in the Darbhanga district, where there are very large tanks, said to have been dug by king Sib Singh.

CHAPTER III.—IRRIGATION FROM CANALS.

918. Flush irrigation, when the water is at a higher level than the field and the cultivator has only to cut the bank of the water channel and allow the water to flow into the field, is called अपटा *apta* in the north-west, and अगर्पाट *agarpat* in Champaran and North-West Tirhut. To the west it is टोर *tor* or मोहर *mohar*. In Patna and Gaya it is चानन *chhanan*, in South Munger मेदान *melan*, and in South Bhagalpur धुरका *dhurka*.

919. Irrigation by lift, when the water has to be raised from a lower level, is called उदाह के पानी ले जाण *udah ke pani le jae* to the west, and in the south-east उखेवा *ukheva*. A dam is sometimes built across the stream to raise the water. This is बाँध *bandh* or बाण्ड *banh* generally; also खाँड़ *khair*, गढ़नी *garni*, and घेरा *ghera* to the north-west, गराँड़ी *garanri* in the north-west, Patna, and Gaya, फाँड़ी *phanri* in Champaran and Patna, गरंडी *garandi* in South Munger, and खान्रो *khantro* in South Bhagalpur. A gang of men employed in making such an embankment is called in Patna and Gaya गोसाव *goam*. A long embankment thrown round a plain of high land in which rice is cultivated, and in which there is a flow of surface water, is डंडेड़ी *danteri* to the north-west and in Patna. South of the Ganges and to the north-west खजाना *khajana*, आहार *ahar*, अहरा *ahra*, and अहरी *ahri* mean the plain itself including the embankment. The embankment as distinguished from the plain is पिंड *pind* or अलंग *alang*. A cutting in the embankment is called in Gaya खान्रू *khanrhu*.

CHAPTER IV.—IRRIGATION FROM WELLS.

920. Wells may be divided into three classes:—

- (a) *Those lined with masonry.*—These are called पक्का *pakka*. In the north-west बाबली *baoli* is a large well, sometimes with a *ghat* or flight of steps running down to the water. इन्दारा *indara*, ईन्दारा *indara*, इन्दार *indar*, or ईन्दरा *indra* is a large masonry well. In South Bhagalpur राहत *rahat* is a masonry well.
- (b) *A well without masonry lining* is called कच्चा *kachcha*; also कुआँ *kuan* or कुयान *kuiyan* or कूप *kup*. In South Bhagalpur भान्रुकी *bhanruki*, and generally भान्रुकी *bhanruki*, is a small well. In Patna and Gaya कन्दरी *kandri* is

a well dug on a river-bank into which the river-water filtrates and is thereby rendered pure.

- (c) *Surface depressions containing water.*—These are चूँ चूँ *chūn* north of the Ganges, चुचारी *chudari* to the west and in Patna, and चुचौँ *chūān* elsewhere. A clay well which has fallen in is called बसल *bhasal* north of the Ganges, and भरन *bharan* in Champaran and North-East Tirhut. In Champaran, Patna, and Gaya it is भत *bhattha*, and to the west भगड़ *bhagar*. All the above are adjectives agreeing with चुचौँ *chūān*. Another expression used in Shahabad is भतकुचौँ *bhathkūān*. The space formed inside a well by the collapse of the sides is खंखर *khānkhar* in the north-west and धोवर *dhodhar* in Champaran and South-West Tirhut. To the west it is पाल *pāl*, and in Patna and Gaya चौँर *chaunr*.

CHAPTER V.—CONSTRUCTION OF WELLS.

921. The large circular excavation made before a masonry well is built is दबड़ *dabar* to the west and in Patna and South Tirhut, and खंखर *khānkhar* to the north. In South-West Shahabad it is गोल *gol*, and in the rest of that district गोल गल *gol gal*. In Gaya it is गोलमार *golamar* or खमार *khahār*.

922. The spring is सोता *sota* north of the Ganges, and also in North-East Tirhut मोका *moka*. In Shahabad it is सोत *sot* or सुती *sutti*, in Patna, Gaya, and South Munger सोर *soi*, and in South Bhagalpur सोत *sot* or सँगरा *sangra*. The side spring in a well is तरसोचा *tarsoa* in north-west and in West Tirhut. Spring-water is बरियार पानी *bariyār pāni*, or in South Bhagalpur सँगरा *sangra*, and in South Munger जिगगर *jiugar*, the two latter words being adjectives. When the spring is tapped the phrase used is, north of the Ganges, तावा टूट गेल *tāva tāt gel*, and south of it बरियार (or जिगगर) पानी बाबि गेल *bariyār (or jiugar) pāni ābi gel*. The hole through which the water rises when the spring is reached is बुड़ *bhūr* or धूर *bhūr*. In Patna and South Munger it is धुरहा *bhurha*. An optional word in South Bhagalpur is बम *bam*. When the spring is copious, it is called धुरफुट *bhurphut*. When the spring is not reached, the well is called सन *sunm*; and a well, when the spring has risen, is पजिचा *paniha*.

923. A well supplied from a spring and not from surface drainage is सुत्तिहा *suttiha* to the west, and सोतन्वी *sothi* in the rest of that district. In Patna, Gaya, and South Munger it is सोरवा *soiya*, and in South Bhagalpur जलधर *jaldhar*. The place where the earth begins to become moist as a well is being sunk is पन्सैक *pansai* or पन्सचा *pansacha* in the north-west. In the south-west it is पसौर *pasoi*, and to the south-east पसेवा *pasewa*. In some cases there is a stratum of sand so fine that it falls in at once and chokes the well. This is known in the north-west as भास *bhas*. The depth to which a well is dug is measured by the height of a man (पूरिस *puris* or पौरन्हा *poraha*). Thus a well is said to be four, five, six, or seven पूरिस *puris* deep.

924. The masonry cylinder of a well is खन्जीर *khanjir*. When a well is made up with circular hoops of kiln-burnt earthenware for sides, these hoops are called खपड़ा or खपरा *khapra*. Other names are (north-west) नाद *nād*, (South-West Shahabad) मोखड़ा *mokhra*, (Patna) गिरदा *girda*, (Patna and South Munger) गंधुवा *ganrua*, and पाट *pāt* in South Bhagalpur. Sometimes a coil of twigs is used for the same purpose, which is known as कोठी *kothi*, दोल *dol*, or बीड़ *bir* in the north-west—the last also in Patna and Shahabad, दोल *dol* in the south-east, and बिन्दी *bindi* elsewhere in the south. Wells protected in this way are कोठिला *kothila* to the west and गढ़ौवाँ *garauān* in Patna. Wells are sometimes lined with a wooden cylinder, and are then called कठकुआँ *kathkūān*. When the cylinder of a well fails to sink, a second smaller cylinder is sometimes sunk inside. This second cylinder is called परचूरे *parchūrē*.

925. The wooden base of the cylinder is made of *jāmun* wood, and is called जमवट *jamvat* or जमोट *jamot*. In South Bhagalpur it is called जमकाठ *jamkāth*.

926. A well so large that two buckets can work it is called दोलही *dolatthi*. In Patna and the south-east it is दुजान *dujāt*, and in South Munger also दुजाना *dujānta*. One for three buckets is तिनकाही *tinlatthi* or तेलही *telatthi*; in South Munger it is तेजना *tejatta*, and in South Bhagalpur तिनकाँत *tinjānt*.

927. The well-dredger and well-spear are described in § 39 and ff.

CHAPTER VI.—THE LEVER USED IN RAISING WATER.

928. This is **धेंकुल** *dhenkul*, **धेंकुला** *dhenkula*, or **धेंकी** *dhenki*. It is also called **लाठ** *lāth*, **लाठा** *lātha*, or **लाठा** *lātha* south of the Ganges, and **जान्त** *jānt* in South Bhagalpur.

929. The *pot* (whether earthen or of iron) is **कुंड** *kūṅr*, **कुंडी** *kūṅri*, or **कुंडी** *kundi*. A smaller iron vessel used for drawing water by hand, and not by means of a lever, is **दोल** *dol*, other names being **लोहना** *lohanra* in Shahabad and **दोल** *dol* in South Bhagalpur. In North-East Tirhut, however, **दोल** *dol* is also used for the lever-bucket. In Gaya **कठनही** *kathnahi* is a wooden bucket for drawing water from a well. The stick placed across the mouth of the bucket to which the rope is fastened is **किल्ली** *killi* or **गुल्लि** *gulli*. In South Bhagalpur it is **रनकिल्ली** *rankilli* or **पुल्लि** *pulli*. The string which fastens this to the pot is **कनेटी** *kaneti* to the north-west and **कुंरियाठी** *kunriyāthi* generally to the north of the Ganges; also **चोरकिल्ली** *chorkilli* in Champāran and North-West Tirhut.

930. The *rope* of the lift is **बरहा** *barha*. It is also called **बरह** *barah* in South Munger, and **हथबरही** *hathbarhi* and **उबाहनि** *ubahani* in Champāran and North-East Tirhut. The short rope joining it to the bucket by a slip-knot is **पञ्चोर** *panchor* or **चोरी** *chhori*, with the following local names:—**चोर** *chhor* (west), **जोता** *jota* (Patna, Gaya, and the south-east), **नाधा** *nādha* (Gaya), **जोती** *joti* (Shahabad and South Munger), and **बगहा** *bagha* (South Bhagalpur).

931. The *lever-beam* is **बाँस** *bāns* when made of bamboo, also **चोप** *chhip* in Champāran and North-East Tirhut. **लाठ** *lāth* or **लाठा** *lātha* is a shorter and stouter one. Other names are **धुरही** *dhurhi* (South-West Tirhut), **धेंकुल** *dhenkul* (west), and **दादा** *danda* (south-east). Sometimes a thin piece of wood is spliced on to the end of the beam. This is called **बंसजोर** *banjor*, and in Patna and the south-east **चोप** *chhip*. The end of the beam which projects beyond the rope over the well is called **अगार** *agār* or **अगारी** *agāri*.

932. The *lever-beam* is weighted with a counterpoise of clods of earth, &c., fixed to the end furthest from the well. These are called **लेद** *led*, **लेदा** *leda*, and **लेदी** *ledi*. In East Tirhut they are **लेच** *lech*, and in South-East Bihār **लेधो** *ledho*. Other names are **पहाड़** *pachhār* (Champāran), **पहेड़** *pachher* (South-East Tirhut), and **चकरी** *chakri* (Champāran, Patna, and Gaya). The peg with which these are

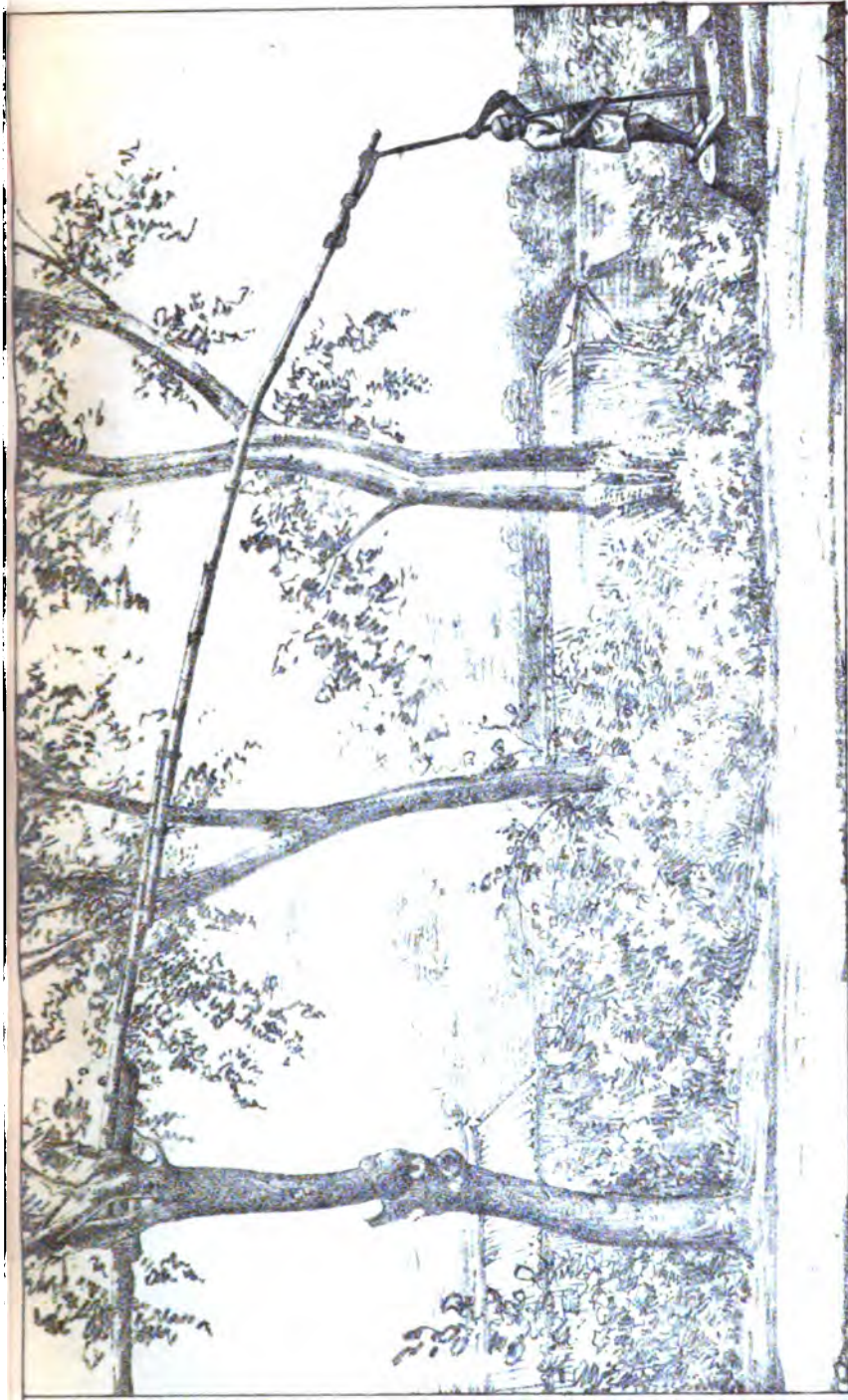

The irrigation lever (lalha), pulled down, with the bucket lowered in the well





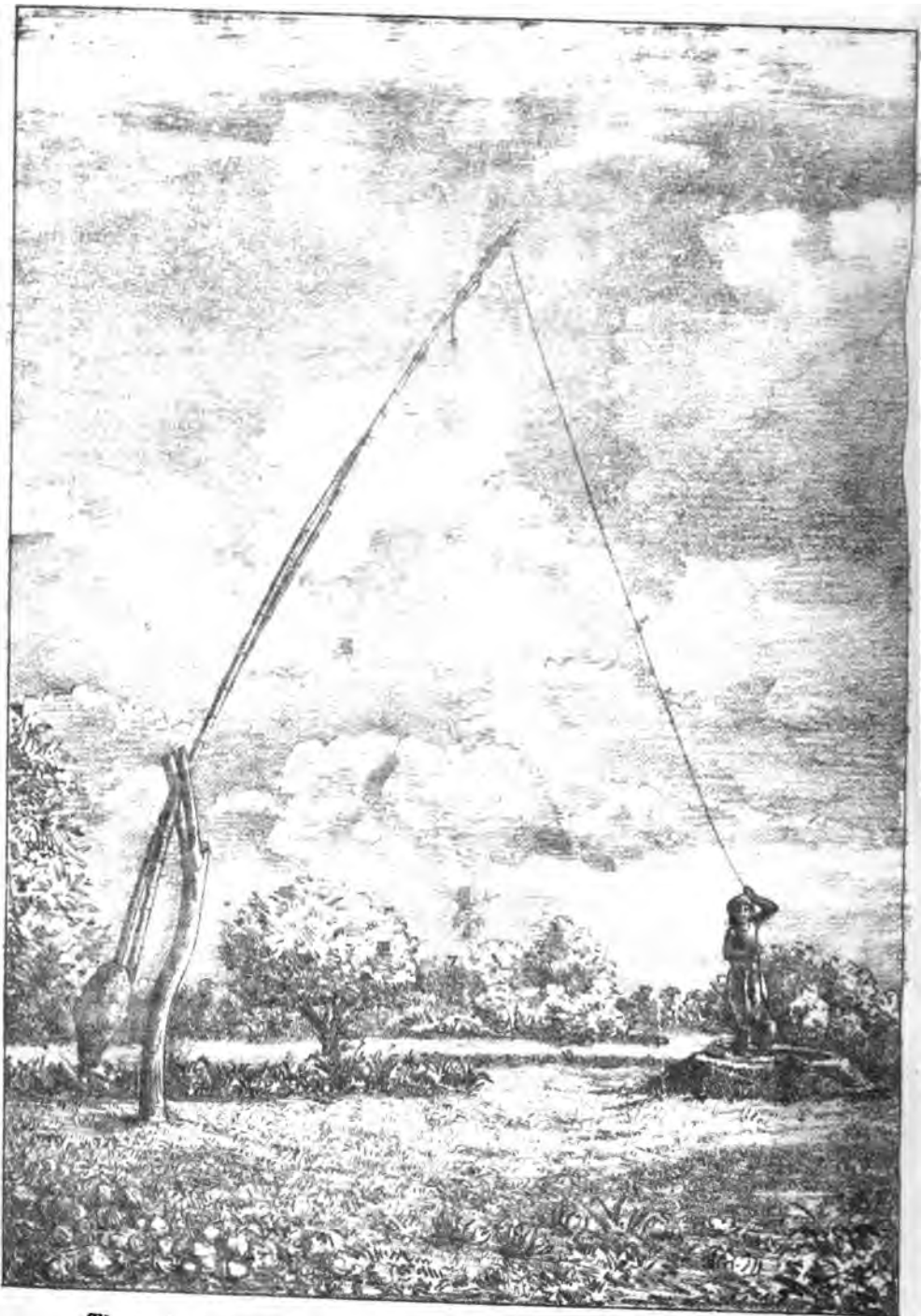

The irrigation lever (latha). raised, with the bucket out of the well

fastened to the beam are खँटा *khānta* or खँटी *khānti*; also गँदमेखा *gāirmekha* (Patna and Gaya), गुली *gulli* (Patna), and किला *killa* (Patna and south-east).

933. The *post* on the top of which the lever swings is कम्बा *khambha*; also धोरेखा *dhorea* in Patna and Shahabad. To the west धुरई *dhurāi* is a post with two branches at the top. These posts are often made of a live tree called जीवज *jiyal* (*Odina Woodier*), which forks naturally in a convenient position, and which will grow if only a piece of it is stuck in the ground, hence its name. The forks are कान *kān*, काना *kāna*, कानी *kāni*, कना *kanna*, or कनी *kanni*. In Champāran and the south-east they are दोकानी *dokāni* or दुकानी *dukāni*. The cross-axle is खौता *akhāuta* or खौत *akhaut*, local variants being खौतो *akhoto* (South Bhagalpur), अखौता *ankhauta* (South Munger), and खेता *akheta* or खेद *akhed* (optional) in Gaya and Patna. Other names are मंजा *mānja* in Champāran and Gaya, and टोना *tona* in Patna. At right angles to and underneath this cross-axle a piece of wood is tied under the lever-beam to keep the axle in its place. This is called मकरी *makri* in Patna, Gaya, and the west. The holes in which the cross-axle works are called खोल *khoh*.

934. The wooden framework over a well on which the person who draws the water stands is called परिखाटा *pariyātha* or पौठा *pauṭha*.

935. When a bucket or *lota* falls into a well, it is pulled up by a set of grappling-hooks, called कँटा *kānta*, कन्टा *kanta*, or जगार *jhaggār*.

CHAPTER VII.—THE SKIN BAG USED FOR DRAWING WATER.

936. The use of this has not been noted in East Bihar. In West Bihar it is मोटि *moti*, मोट *mot*, or मोंट *mont*. The iron ring round its neck is मँदरा *menrra*; also कड़ाही *karāhi* and कड़ा *kara* in Saran, and कँरा *kāra* in South-West Tirhut. The rope or cord which joins the bucket to this iron ring is नथियारी *nathiyāri* or सोरही *sorhi*; also नथिया *nathiya* in South-West Tirhut. The semicircular pieces of bent wood fastened to the ring to keep the mouth of the bucket open are घोरे *ghorāi* or घोरांनी *ghorāni*. To these are fastened two rings of iron, which are called कड़ी *kari* or बाला *bāla*. किली *killi* or गुली *gulli* is a wooden peg by which the bucket is fastened to the well-rope.

CHAPTER VIII.—OTHER WELL-APPLIANCES CONNECTED WITH IRRIGATION.

937. The portion of the mouth of the well on which the bucket rests as the water is being discharged is called **अर्दाँच** *arāns* or **अँदाँच** *anrās*. Sometimes this is of wood. On this straw or rushes are placed to save the vessel and prevent splashing. In Patna and Gaya this cushion is called **सीठा** *sitha* or **बिन्दा** *binda*, and in South-West Shahabad **जेंगड़ा** *jhengra*. In Saran a similar article made of leather is called **छा** *chhalla*. When made of straw in Saran it is called **चचार** *chachār*, and in Champāran **चचरा** *chachra*. The catch-basin into which the bucket is emptied is called **तीठा** *titha* to the west. Elsewhere it is called **अर्दाँच** *arāns*, **सीठा** *sitha*, &c., as above.

938. The bullock yoke, which has two bars (see § 14), is **पाळो** *pālo* **मोठग्या** *pālo motha* or **जुवाठ** *juāth*. Local names are **जोठ** *joth* (Patna) and **जूवाड़** *jūar* (Champāran and Gaya). In Champāran, Patna, Gaya, and South Munger **पाळो** *pālo* is used. The above names are also used for the upper bar, and also **पळा** *palla* in South-West Shahabad. The lower bar is **तरचरीळ** *tarsail* or **तरचैळा** *tarsaila*, local names being **सेळा** *saila* in Shahabad, **गगार** *gātār* in Champāran and Gaya, and **जखड़** *jahar* in the south-east. The outer pins joining these two bars, and which go outside the bullock's necks, are called **चरीळ** *sail* or **सेळा** *saila* to the west, and **कनैळ** *kanail* to the north-west and east. The similar pins inside are **चमेळ** *samail* or (Patna and the south-east) **चमेळा** *samaila*. They are also called **पचार** *pachār* in Shahabad. The knob to which the rope is fastened is **महादेवा** *mahādeva*. In the south-east it is **महन्देवा** *mahndeva*.

939. The wooden framework over the mouth of a well to prevent people falling in is **जंगळा** *jangla*. The wooden beam laid over the well on which the person drawing the water stands is **पावठ** *pāvath* or **पौठा** *pautha*. Other names are **लतमरा** *latmara* (Patna and North-West Tirhut), **गोड़पौठा** *gorpautha* (South-West Tirhut), and **धरणा** *dharna* (Champāran and South Munger). The masonry work at the mouth of a well is **जगत** *jagat* to the west. Other names are **मुंढेर** *murer* (west), **मुंढेरा** *munrera* (also in Champāran) or **निरारी** *nirāri* in Patna, **मुंढेरी** *mureri* in Champāran and Gaya, and **मूढा** *mūrha* in the south-east.

940. The pulley is generally supported in the fork made by two lopped branches of the trunk of a tree erected by the well. This trunk is called **धुरची** *dhurhi* or **खम्हा** *khamha* to the north-west and in South Munger. South of the Ganges we have **धुराँ** *dhurā* or **धोरेळा** *dhorea*

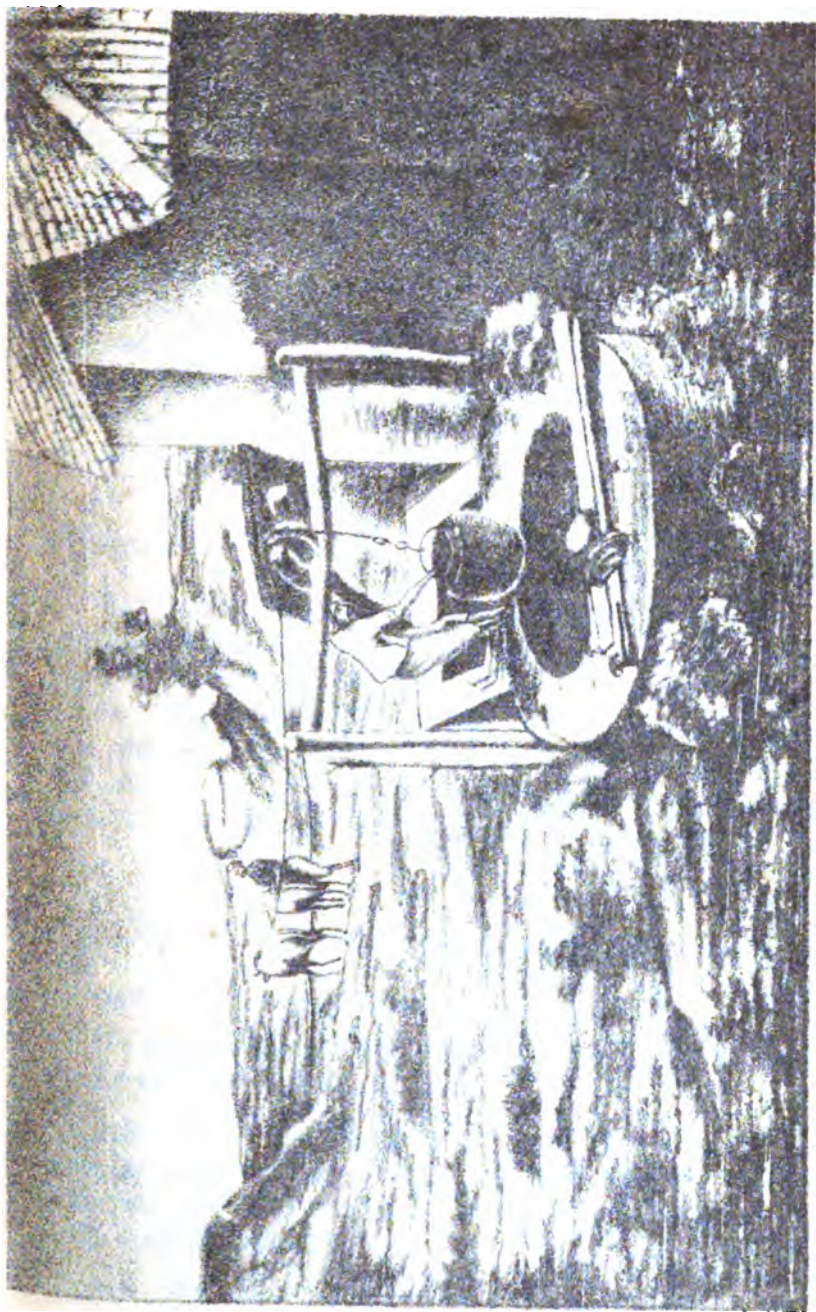

The skin bag for drawing water (motsi), as worked with bullocks

(Note - The photograph had necessarily to be taken from a great height, which throws the picture somewhat out of perspective. Really the bullocks are going down hill and the receding vat is level.)



in Shahabad. In Gaya it is जसर *jaser* or दसर *daser*, and in Champāran, Patna, and the south-east बन्ना *khambha* or खन्ना *khamha*. Other names are थुन्ही *thunhi* in Patna and Shahabad and दोकानी *dokāni* in the south-east. The cross beam is बँडेरा *banrera* in the west, and बन्ना *balla* in South-West Tirhut. In parts of Shahabad it is अराठ *arāth*, and in Patna and Gaya पाठ *pāt*. The branches in which the pulley works are कन्ना *kanna* or कानी *kāni*, and the pulley axle बखौत *akhaut* or बखौता *akhauta*. Other names for this last are दन्ना *danda* in Champāran and South-West Tirhut, सररा *sarra* in South-West Shahabad, and टोना *tona* in Patna. The pulley itself is गहारी *gharāri* to the west, also गहारी *garāri* to the north-west and in South Munger. It is घिरनी *ghirni* in Champāran and South-West Tirhut, Patna, Gaya, and South Munger, गद्दा *gadda* in South-West Shahabad, घुर्नी *ghurni* in Patna, and मकरी *makri* in Champāran and to the south-east.

CHAPTER IX.—THE PATHWAY FOR THE BULLOCKS, &c.

941. The sloping pathway for the bullocks is पौदर *paudar*, also दार *dawar* in Shahabad, बाही *bahi* in Gaya, and दगर *dagar* in Champāran, Patna, and the south-east. In South Munger it is also गोकुपौर *gorpaur*. The portion above ground is पौदर के मँथ *paudar ke mānth*, or to the west मथार *mathār*. The portion below ground is खोईया *khoinchha* to the west. A yoke of well-bullocks is called मोठ्या जोड़ी *mothā jori*. Drawing water by cattle power is मोठ बहाप्रव *mot chaldēb*.

CHAPTER X.—THE WORKMEN EMPLOYED AT THE WELL.

942. The following labourers are employed at the well:—

The bullock-driver.—He is हँकवा *hankwa* or हँकनिहार *hanknihār*; also फेरवा *pherha* in Shahabad.

943. *The man who empties the water-bag.*—He is धरनिहार *dharnihār* north of the Ganges, चिन्वा *chhimwa* in South-West Shahabad, and मोठधरवा *motdharwa* in the rest of that district and in South Munger.

944. Both these men are called north of the Ganges मोठवावा *motwāha*.

945. *The man who distributes water in the field* is called पन्मोर *panmora* or पन्चन्ना *panchhanna* north of the Ganges. South of the Ganges he is बरवाह *barwāh* in South-West Shahabad, मोरवाह *morwāh* in the rest of that district, and खंरुवार *khanruār* in Gaya. He is also खरवाहा *kharwāha* in Saran and खंरुवाहा *khanrwāha* in Patna.

946. *The man who distributes the water with a spade* has already been described in Chapter I of this subdivision.

CHAPTER XI.—THE PERSIAN WHEEL.

947. The Persian wheel is not used in Bihar. Its name, राहत *rahat*, is however known in Patna.

CHAPTER XII.—IRRIGATION FROM TANKS AND STREAMS.

948. Water is raised from these either by the swing-basket or by the spoon-lever.

949. *The swing-basket*.—The swing-basket is generally सैर *sair* to the west and चाँड़ *chānr* in Central and Eastern Bihar. In Tirhut it is also डोस *dhos*, in South-West Shahabad दौरा *daura*, in Champāran and Gaya सर *sar*, and to the south-east सैन *sain*. The strings from which it swings are डोर *dor* or डोरी *dori*. The place where the men stand who work the basket is गोरपौर *gorpaur*, or to the west पौधा *pauḍha*. In South Bhagalpur it is सैनार *sainār*. The men who work it are सैरवाह *sairwāh*, चाँड़वाह *chanriwāh*, or डोसवाह *dhoswāh* in the above-mentioned localities respectively. To work the basket is सैर (चाँड़ or डोस) चलाएब *sair (chānr or dhos) chalāēb*. In South Bhagalpur it is सैन चलाएब *sain barāēb*. The pit from which the water is lifted is चरियार *chariyār* in Gaya and South Munger.

950. *The spoon irrigation lever*.—This is a long log of wood hollowed out like a spoon. It is so balanced that the bowl end is over the water to be raised. It is depressed into the water by the foot, and, rising by its own balance, discharges the water along its stem into the higher catch-basin. It is called डोन *don* to the west, and करीन *karin* or करीग *karing* to the east. The man who works it is called डोनवाह *donwāh* and करीनवाह *karinwāh* or करीगवाह *karingwāh* respectively. The place where he stands is पौठा *pauṭha* in the west and अत्तरा *altmara* in Tirhut.

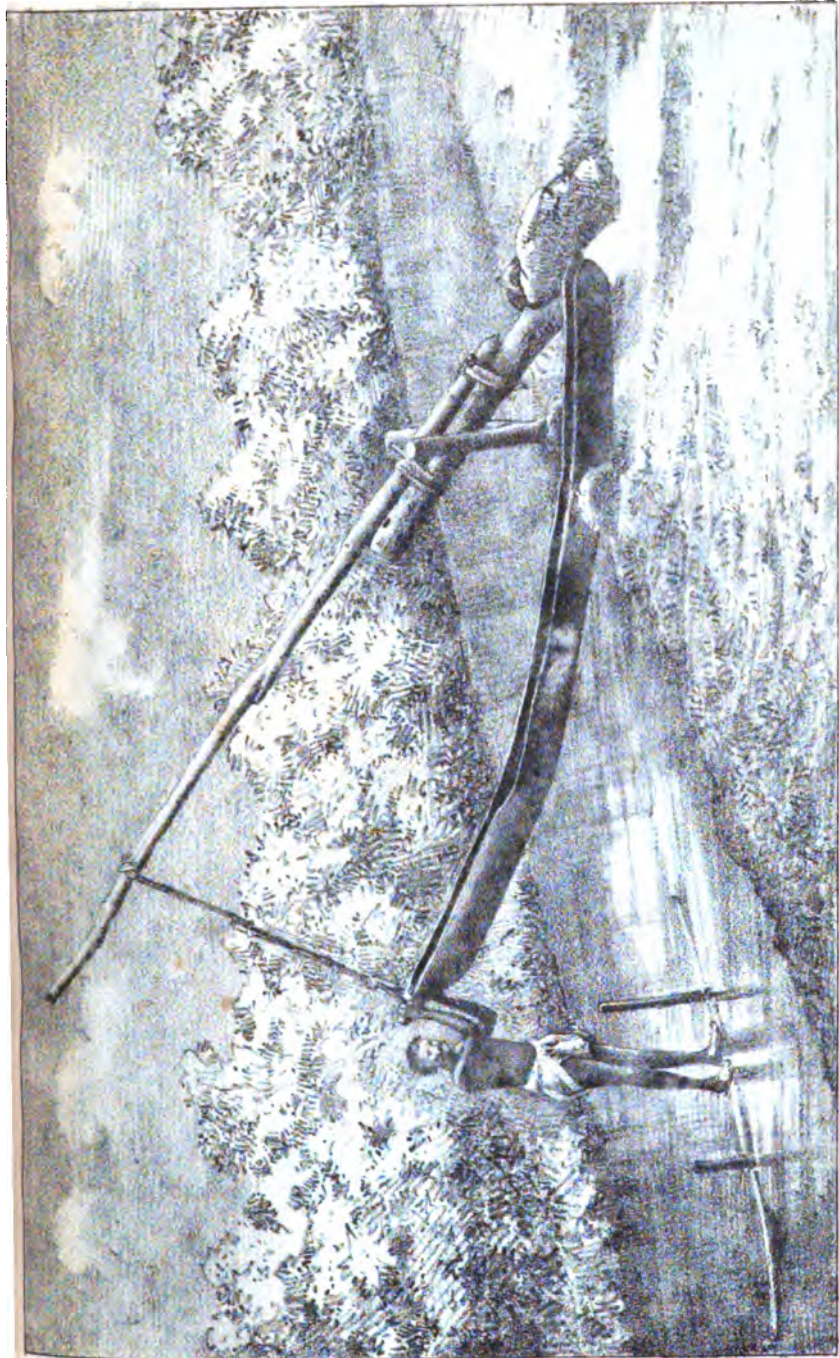

Irrigation lever (latha), showing the method of discharging water.



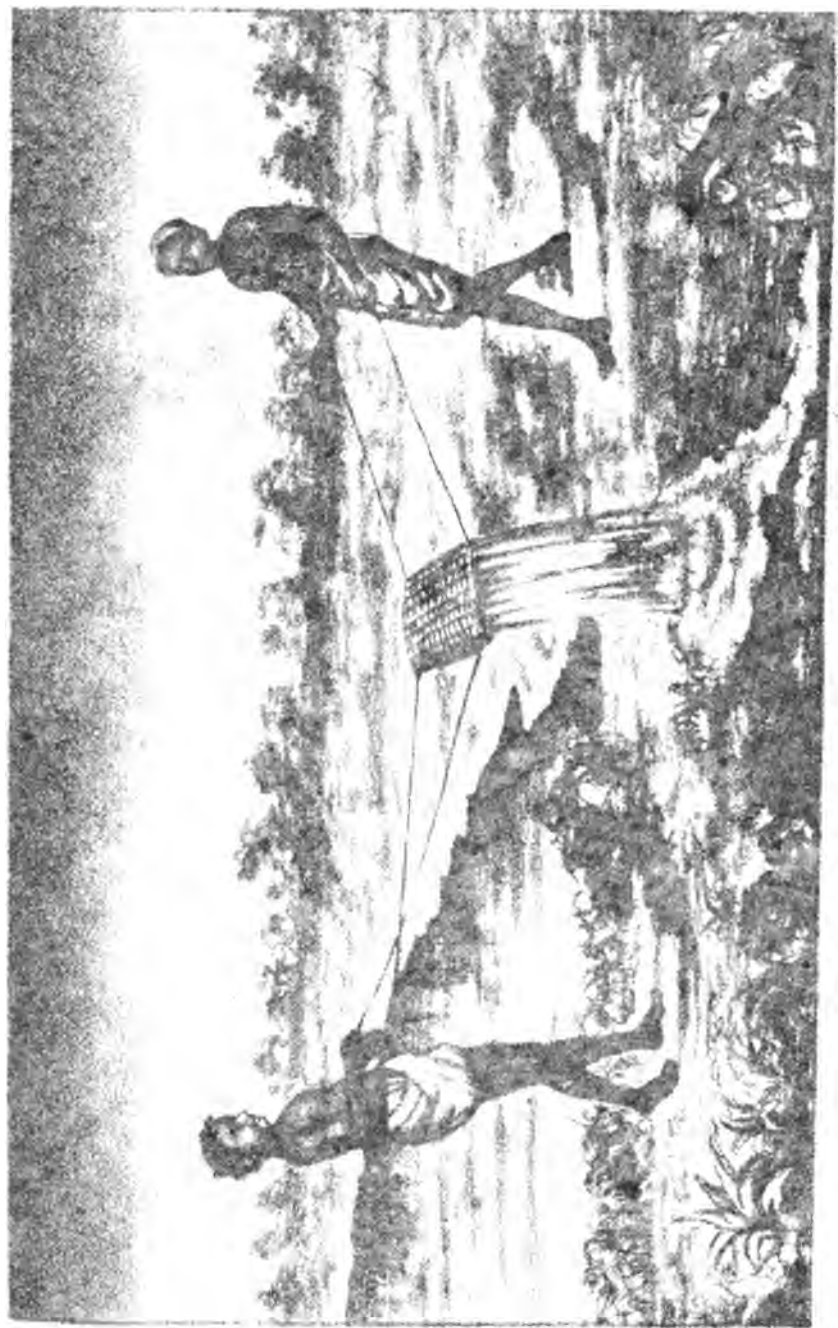

Water-lifting with the sowing-basket (sair or rhanr).





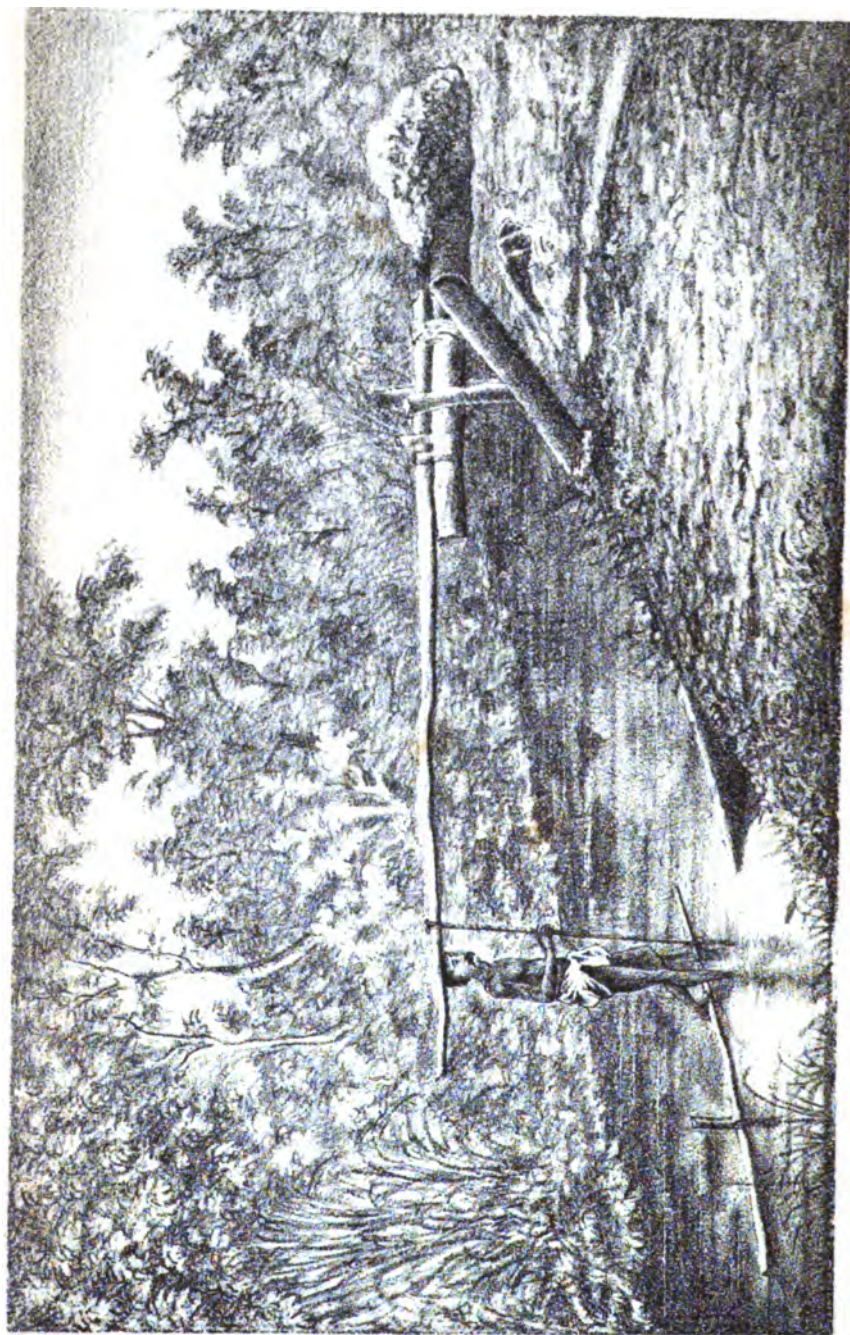

Irrigation lever (latka), showing the method of taking in water

CHAPTER XIII.—WATER-LIFTS AND OTHER TERMS COMMON TO IRRIGATION BY THE SWING-BASKET AND THE SPOON-LEVER.

951. The height to which the water is lifted is बोहर *bodar* in Saran and Shahabad, अनुवा *anua* in Champaran, and गार *gār* in North-West Tirhut. South of the Ganges it is चहाव *charhāo*, अनौवा *anaua* in South-West Shahabad, and एघानु *eghānu*, &c., as follows.

952. When there are several lifts, the first reservoir is called ठेका *thēka* in the north-west, पहा गार *pahla gār* in North-West Tirhut, and कानर *kānar* in North-East Tirhut. South of the Ganges it is खजाना *khajāna* or एघानु *eghānu*. Of this last there are local variants एघावा *eghāwa* in Patna and एघाय *eghāy* in South Bhagalpur. The top of the lift is अरानी *arāni* to the west, and सीठा *siṭha* in South-West Tirhut, Patna, and Gaya. The catch-basin from which the water flows into the field is तीथा *tīṭha* to the west. It is also पारहा *parchha* in South-West Shahabad, and मेहवानी *mehvāni* in Gaya.

953. When there are two or more lifts, the second from the bottom is दोघानु *doghānu*, with a local variant दोघावा *doghāwa* in Patna. The third is तेघानु *teghānu*, or in Patna तेघावा *teghāwa*. The fourth is चौघानु *chaghānu*, or in Patna चौघावा *chaughāwa*. These lifts are also called ठेका *thēka* in South-West Shahabad. Thus दो ठेका *do thēka*, तीन ठेका *tin thēka*, &c. The raised bank between the two reservoirs is खानवान *khānwān* in South-West Shahabad and मँड़ *menr* in the rest of that district. In Gaya it is पीँड़ *pīnr*, and in Patna अलंग *alang*. In South Munger and Patna it is आचर *āhar*, and elsewhere बाँध *bāndh* or बाह *bāh*.

CHAPTER XIV.—WATER-CHANNELS.

954. The channel which conveys the water into the field is generally पैन *pain* or पैनि *paini*. In Patna, Saran, and Shahabad it is also करहा *karha*, and in South-West Shahabad बाहा *bāha*. In Tirhut it is पौठ *pauth* or दवान *dawan*, and in North-East Tirhut पौडी *pauti*. In South-East Tirhut it is बह *bah*. To the west नारी *nāri* is also used. In the south-east and Champaran we find दानर *dānr*, and also (in South Bhagalpur) सिँगा *singha*. In North-East Tirhut कनवा *kanwa*, and in Patna and Gaya कनुवा *kanuwa*, is a narrow branch channel leading from a पैन *pain*. A water-course generally is नदी

naddi or (in South Bhagalpur) लक्ष्मी *laddi*, and its branches बाघा *bāha* or (north of the Ganges) बाघना *bahna*. In Shahabad खेर *akher* is a shallow spring of water, and its branches निग्रहिन *nigrain*. In Patna and Gaya भोकिहा *bhokila* and टँडूवा *tanrua* are small water-channels. The latter is smaller than, and is a branch of, the former. A turn in a water-course is मोरानी *morāni* in Patna and the north-west, and घुमान *ghumān* in Champāran and North-East Tirhut.

DIVISION V.

AGRICULTURAL PRODUCTS AND THEIR ENEMIES.

SUBDIVISION I.

AGRICULTURAL PRODUCTS.

CHAPTER I.—WHEAT.

955. Wheat (*triticum vulgare* or *sativum*) is गेहूँ *gehū* north of the Ganges. In East Bihār generally, however, it is गहम *gahum*. To the west it is also गेहूँ *gehū*, and elsewhere south of the Ganges and in North-East Tirhut गेहम *gehūm*. In Gaya it is also मन्दा *manda*. Cf. § 823.

956. The chief varieties are मुँडिया *munriya*, a first-class beardless wheat. In South-West Shahabad this is मुँडिलवा *munrilwa*, मुन्दा *munda* in Sāran and Patna, and मुन्दी *mundi* or भुँडिया *bhūṅriya* in Gaya. दाँदी *dāudi* or दौदी *daudi* in West Bihar, or to the south-west and in Gaya दौडिया *daudiya*, is an excellent white beardless wheat. In Tirhut it is known as जमाल खानी *jamāl khāni*. A white round-bearded wheat is known as दूधी *dūḍhi* or दुधिया *dudhiya* in South Tirhut, Patna, and South Munger. In South Bhagalpur it is पचरुकी *pachrūki*. लका *laka* in Shahabad and South-West Tirhut, देसी *desi* or देसिला *desila*, and हर्ना *harna* or हार्रहवा *hārrahwa*, in the north-west, हारा *hāra* in Tirhut, हरहरा *harhara* in South-West Tirhut, हरहा *harha* (Patna), केवालहा *kevalha* (Gaya), and जमाली *jamālī* or जमरिया *jamariya* to the east, are a small-grained red wheat. लका *laka* also occurs in South Munger. North of the Ganges दोग्ला *dogla* is a mixed wheat composed of जमाल खानी *jamāl khāni* and हारा *hāra*. बर्गहमा *bargahuma* in South-East Tirhut is a large bearded wheat. In Shahabad रेंरा *renra* means stunted wheat.

957. The germ of a grain of wheat is south of the Ganges पुत्ती *putti*. When a grain of wheat germinates first, the sprout is called सुइया *suiya* or सूया *sūa*; also अंकुरा *ankurha* to the north-west, and

कन्नी *kanni* in Patna. In North-West Tirhut it is देप *deph*, and to the east देफी *dephi*. The phrase used is सुइया गेह *suiya gail* north of the Ganges, or देप निक्सल *deph niksai* in North-East Tirhut. To the west they say रेंदल बा *renral ba* or रेंदु गेह *renr gail*. In Gaya they say सुआल बावे है *sua awe hai*, and in Patna कनिदाएल बावे है *kaniyâel awa hai*. When it has further sprouted, but has not yet taken firm root, it is पुनग्रा *putra*. When the blade throws out shoots they are called दिबिी *dibbi*; also दाबिी *dâbhi* in South-West Shahabad, and टेम्बिी *tembhi* in Patna. When about six inches high it is called कौवा लुकान *kaua lukân* in Gaya, Saran, and Shahabad, and कौवा जपान *kaua jhapan* in the south-east, both meaning sufficiently high to hide a crow. When it is out unripe it is known as होरगा *horha*, or (Tirhut and the South-East) ओरगा *orha*, and (optionally) in South Munger as होल्गा *holha*. When the ear begins to form, they say रेंदा गेह बा *renra bhail ba* in the north-west, गभा गेह बा *gabha bhail ba* in South-West Tirhut, and गम्हरा गेह बलि *gamhra bhel achhi* in the rest of Tirhut. In Shahabad they say दुधियाएल *dudhiyâel*. In Patna and Gaya a similar phrase, or the phrase गदराएल है *gadrâel hai*, is used, and in the south-east they say दुधेले *dudhailai*. गदराएल *gadrâel* is also used in Tirhut. When the grain hardens they say it is हबसाएल *habsâel* in South-West Shahabad, कैलाएल *kailâel* generally; in Saran and West Tirhut also गोटाएल *gotâel*, अडपकु *adhpakku* in Gaya, कैला गेह *kaila gel* in Patna, and कलाएल *kalâel* in the south-east.

958. The beard is टुंर *tünr* or टुंरा *tünra* to the west, and सँघ *süngh* or सँन *sünng* elsewhere. In South-West Tirhut it is सँर *sünr*. The ear itself is बाल *bâl*, except in North-West Tirhut, where it is बाबिी *bâbi*; in South-East Tirhut, where it is सीस *sis*; in South Bhagalpur, where it is सीसा *sisâ*; and in South Munger, where it is टुंगगा *tungna*.

CHAPTER II.—MIXED CROPS.

959. Wheat and barley grown together are गोजर *gojai*. A mixture of peas, gram, barley, or wheat, or any two or three of them, is called तेररा *terra* in South-West Shahabad, गजर मसर *gajar masar* in the rest of that district, गजर गजर *gajar bajar* in Champaran, गजा गजा *gaja baja* south of the Ganges generally, and उटरा *utra* in Patna. In the north-west it is पैरा *paira*, in West Tirhut पैर *pair*, and in East Tirhut पौर *paur* or बेजरा *bejhra*. Barley grown with the smaller pea (केराव *kerdo*) is जौ केराव *jau kerâo*

generally, also जौ मट्टरा *jau matra* to the west, जकेरार *jakerāi* to the south-east, and जब केरवा *jab kerwa* in North-East Tirhut. Other names are कुसही केराव *kusahi kerāo* in Patna and the south-east, कोसी *kosi* in South Bhagalpur, and हारफोरवा केराव *harphorwa kerāo* in South-West Shahabad. बेररा *berra* or बेरई *berāi* in Shahabad is barley mixed with gram, and the same is called जब बुहा *jab butta* north of the Ganges, and जो बहा *jo butta* in the south-east. जो खेसरा *jo khesra* is a mixture of barley and peas (खेसारी *khesāri*) in the south-east.

960. When there is a mixture of crops, the inferior one is called तरी *tari* when compared with the other. Thus in जौ केरार *jau kerāi* the small pea (केराव *kerāo*), being the inferior, is the तरी *tari*.

CHAPTER III.—BARLEY AND OATS.

961. Barley (*hordeum vulgare*) is जौ *jau* generally. In the north-east it is जब *jab*, and in Patna and the south-east जो *jo*. North of the Ganges जरै *jai* (also in Shahabad) or जतारी *jantari* are shoots of barley artificially grown and distributed by Brāhmans at the festival of the Dasahra. In Gaya they are जवारा *jawāra*, and in Patna जैती *jainti*. The prickly hairs on the ear are टूँर *tūnr* in West Tirhut, Saran, and Shahabad; टूँरा *tūnra* or सूरहा *sūnrha* in Champāran and Tirhut; सूर *sūr* in South-West Tirhut, and also सूर *sūrh* or सूर *sūng* in Patna and the east generally.

962. Oats (*avena sativa*) are called the sister of barley, and are hence named जरै *jai* or जै *jai*.

CHAPTER IV.—RICE.

963. Rice (*oryza sativum*), whether as a crop or threshed but unhusked, is called धान *dhan*. When husked it is चावल *chāūr*, but the Hindi form चावल *chāwal* has also been noted in Patna. Husked rice is of two kinds, viz. अरवा *arwa*, which is not parboiled before husking and is eaten by the higher castes, and the cheaper, which is parboiled before husking and is eaten by the lower castes. This latter is called उसिना *usina*, उसना *usna*, or जोसँदा *josānda*. Rice when partially husked is called मुहचुर *muhchur* in Gaya, बोकड़ा *bokra* in Saran, and खिजावा *khijāva* in North-East Tirhut. Rice boiled plain is धान *bhat*, when boiled with pulses it is खिचड़ी *khichri*, and when spices are added to this it is धानल खिचड़ी *bhanal khichri* or कबली *kabali*; also in

South Bhagalpur *खीकी* *akhāunki*. When rice is boiled to a mash, it is called *गोखन्दा* *golhath* or *गोखन्दी* *golhatthi*. In Gaya *पनिहता* *panihata* is a dish made by adding water to the rice left from last night's supper. In addition to the usual names, *लार* *lār*, *पोखार* *poār*, &c. (see § 894), the long straw of transplanted rice is called *मोरी पेढारी* *mori petāri*, or (in Champāran) *पेढारी* *petāhi* or (in Shahabad) *पेढारी* *petārhi*.

964. The varieties of rice grown in Bihār are very numerous, as is borne out by many proverbs, such as the following :—*राजपूत को धान के खोर नाहिं है* *rajpūt o dhān ke or nahīn hai*,—there is no limit to the clans of Rajputs or the kinds of rice; *धान बाबन के एके बाब* *dhān bābhan keñ ekke hāl*,—rice and Babhans are one and the same (in number of kinds). Rice may be divided into two broad classes, those which are sown at once broadcast and are called *बाबग* *bāwag*, *बाबोग* *bāög*, (in Gaya) *बोगेड़ा* *bogera*, or in Patna *बोगड़ा* *bogha*, and those which are sown in seed-beds and transplanted, being called *रोप* *rop* or *रोपा* *ropa* or (in Gaya and Patna) *रोपड़ा* *ropḥa*. At the same time it should be noted that practice varies with locality, and that a kind of rice which is *बाबग* *bāwag* in one place may be *रोपा* *ropa* in another.

A.—RICE THAT IS SOWN BROADCAST.

965. (1) *साठी* *sāthi*.—This is a red rice, and ripens in sixty days from sowing, as in the proverb—

*साठी पाके साठ दिन,
बरखा होके रात दिव.*

*Sāthi pāke sāth din,
Barkha hokhe rāt din.*

—*Sāthi* ripens in sixty days if it rains night and day.

In the east it is also called *गम्हरौ* *gambhri* or *गम्हरी* *gamhri*. It is sown in the month of Jeth (May–June), and is out in Sawan (July–August).

(2) *सोखना* *sokna* (north-west).—This is sown with the first fall of rain in Jeth (May–June), and is out in Bhādoñ or Āsin (*i.e.*, in September). This crop is also called *भदैया* *bhadaiya*.

(3) The following are sown in Phāgun (February–March) and Chait (March–April), and are out in Aghan (November–December). The names were principally

collected in *East Tirhut*, and unless the contrary is specially stated do not apply elsewhere :—

- (a) बकास गौर *akal bir*. (In *Sāran* बकास गौर *akal gir*, and in North-East Tirhut also काला गौर *kāla gir*.)
- (b) उजागर *ujāgar*, or in *Sāran* जागर *jāgar*, which name is also current in North-East Tirhut.
- (c) चनाबक *chanābak*.
- (d) जलमरदान *jhalmarādan*.
- (e) दरमी *darmi* (also known in the north-west).
- (f) देसरिया *desariya* (Tirhut and Champāran). In *Sāran* it is called जसरिया *jasariya*.
- (g) पीचर *picar*.
- (h) बेजौर *belaur* (also known in the north-west).
- (i) भाँटिन *bhāntin* (*Sāran*).
- (j) भैसलेट *bhaislet* (also known in the north-west).
- (k) लॉजी *lanji* (*Sāran*).
- (l) सतरिया *satariya* (*Sāran*).
- (m) साहिल *sāhil* (*Sāran*).
- (n) सिंगरा *singra*.
- (o) सोबरा *sobra*.

खेड़ा *kherha* is a white bearded rice sown all over Tirhut and in Champāran. The following (also East Tirhut) are sown in Jeth (May-June). They are sometimes sown broadcast and sometimes transplanted :—

- (a) धुसरी *dhusri* (also known in Champāran).
- (b) बस्तार *bastar*.
- (c) राम दुलारी *rām dulāri*.

966. In *South-West Shahabad* the following kinds of rice are sown broadcast :—

- (a) करंगा *karnga* } Two kinds with a black grain (also known
- (b) करंगी *karngi* } in *Sāran*).
- (c) करहन्नी *karhanni*, a small black grain (also known in *Sāran*).
- (d) खाटिन *khātin*, a coarse kind.
- (e) सहदेया *sahdeiya*, a red kind.
- (f) साठी *sāthi*. See above.

(g) **शेरा** *serha*, a small black and white grain. Like the **साठी** *sāthi*, it ripens in sixty days. The South-West Shahabad version of the saying already quoted is—

शेरा साठी साठ दिन, जेव देव बरसे रात दिन
Serha sāthi sāth din, jemo deb barse rāt din.

—*Serha* and *sāthi* take sixty days if it rain night and day.

In the rest of *Shahabad* the following kinds of rice are sown broadcast:—

- (a) पन्सारी *pansāri*.
- (b) भुईसीकर *bhuinsikar*.
- (c) मंगा *mānga*.
- (d) राम करन्धनी *rām karhanni*.
- (e) राम दुलारी *rām dulāri*.
- (f) साबिल *sābil*.
- (g) सिरहंत *sirhant*.

967. In *Gaya* sowing is done in the month of Akhār, in the lunar asterism of *Aradra* (June–July). About this asterism (**बख्खर** *nachhattar*) and the two following ones the following rhyme is current throughout Bihar:—

बख्खरा धान, पुनरबस पेवा
 गेल, किसान, जे बोए चिरैया
Aradra dhān, Punarbas paiya,
Gel, kisān, je boe Chiraiya.

—Paddy sown in *Aradra* turns into plenty, sown in *Punarbas* to chaff, and sown in *Chiraiya* (or *Pukh*) it turns to nothing.

The paddy is generally cut in the month of Pūs (December–January).

Amongst the kinds of paddy sown broadcast in this district are—

- (a) एदली *edli*.
- (b) कतिका *katika*,—cut in *Kātik* (October–November).
- (c) कन्बदा *kanbada*.
- (d) करन्धनी *karhanni*.
- (e) जोंगा *jonga*.
- (f) जहन्गा *jhanrga*.
- (g) दुसरा *dhusra*
- (h) रतवा *ratwa*.
- (i) लालदेया *laldeiya*.

- (j) लोहरा *lohra*.
 (k) सिरहती *sirhatti*.

968. In *Patna* on the first fall of rain, which generally takes place in the asterism of *Rohini*, in the month of *Jeth* (May-June), the sowing is commenced. Paddy which is sown broadcast is divided into two classes—a red, which is considered superior, and is called लण्गोदिया *laigondiya*, and a black, which is considered inferior, and is called कारा लोहरा *kāra bogha*. The former kind includes करहती *karhanni* as the principal. The ear is black.

969. In *South Munger* the following kinds are sown broadcast :—

- (a) अजान *ajān*, a white variety.
 (b) कजरी *kajri*.
 (c) करहती *karhanni*. See above.
 (d) खिरदन्त *khirdant*.
 (e) चहग्रा *chhagra*.
 (f) जौगा *jauga*.
 (g) पनसाहा *pansāha* (a coarse red kind).
 (h) बुढ़वा *burhwa*.
 (i) रंगी *rāngi*.
 (j) सरिहान *sarihan*, a white variety.
 (k) सिरहती *sirhatti*.

970. In *South Bhagalpur* the following kinds are sown broadcast :—

- (a) कजरघरो *kajargharo*.
 (b) गोहमा *gohma*.
 (c) चांग *chāng*.
 (d) जौगा *jonga*.
 (e) दुदसर *dudsar*.

B.—RICE THAT IS TRANSPLANTED.

971. This rice is generally sown with the first rains in *Jeth* (May-June). It is transplanted in *Sawan* (July-August). In *Patna* the custom is to commence transplanting on the 5th of *Sawan*, after holding a festival, called नक्षत्रांचो *nakpāncho*, or the “fifth of the asterism (नक्षत *nakhat*).” The regular harvest is held in *Aghan* (November-December). Before this, however, some is cut for the ceremony of बिहुन पिरित *bisun pirit* (called in *Saran* बिहुनदिया *bisumatiya*), at which *Brāhmins* are feasted on the new grain.

972. The following kinds of rice are transplanted in *Tirhut* :—

- (a) अङ्गा *anga*, a black bearded kind.
- (b) कनक जीर *kanak jir* (East Tirhut).
- (c) कमीच *kamoch*, a black kind grown in North-West.
- (d) करमा *karma*, a long black kind (Tirhut).
- (e) गहमा *gahuma*, a red flat kind grown in North-East Tirhut.
- (f) जगरन्धिका *jagarnathiya*, a similar kind grown in North-West Tirhut.
- (g) दुधराज *dudhraj*, small and white.
- (h) नन्धिया *nanhiya* (East Tirhut).
- (i) बहरन्गी *baharni* (North-West Tirhut) or बहोरन्गी *bahorni* (North-East Tirhut), a long white variety.
- (j) भाङ सरी *bhāl sari*.
- (k) मनसरी *manasri*, a red variety (also known in Saran).
- (l) माङ भोग *māl bhog*.
- (m) रामुनी *ramuni* (also known in Saran).
- (n) लाल देरवा *lal deiya*, or in Saran लालदेरवा *laldeiya*, a red variety.
- (o) सरिहन *sarihan* (north of the Ganges generally), sown in Baisakh (April-May) and cut in Sāwan (July-August).
- (p) सिलहट *silhat*, with a black husk but white grain.

973. In *South-West Shahabad* the following are transplanted :—

- (a) जलहोर *jalthor*, possesses a fine grain.
- (b) जेंगी *jhengi*, a white variety.
- (c) दुधकांर *dudhkānrar*, white.
- (d) बासमती *bāsmati*, a superior white variety.
- (e) बैतर्नी *baitarni*, a reddish kind.
- (f) भेंकबाबर *bhenrkābar*, a coarse red kind.
- (g) माङ देही *māl dehi*, a fine-grained variety.
- (h) मुतुनी *mutuni*, white.
- (i) रामजूषा *ramjūa*, fine.
- (j) लोंगचूरा *longchūra* (a black and very fine variety).
- (k) सिरि केबल *siri kebal*, white.

974. In the rest of *Shahabad* the following are transplanted :—

- (a) कनकजीरा *kanakjira*.
- (b) दुलहरा *dulahra*.
- (c) दोलङ्गी *dolangi*.

975. In *Gaya* the following are transplanted :—

- (a) कमग्वा परग्वाद् *kamla parsad*.
- (b) गजग्वा गज्पात्ता *gajpatta*.
- (c) गुडग्वा *gudra*.
- (d) गोखुल फूल *gokhul phal*.
- (e) गोपाळ भोग *gopai bhog*.
- (f) ठाकुर भोग *thakur bhog*.
- (g) दुधग्वा *dudhgilas*.
- (h) धनीवा *dhaniwa*.
- (i) नौ धारा *nau dhara*.
- (j) बकोरवा *bakoiya*.
- (k) बत्तास पेनी *batas pheni*.
- (l) बत्तावा *batasa*.
- (m) बरन्टी *branti*.
- (n) बांसग्वाती *basmati*.
- (o) माधग्वा *madhwa*.
- (p) मुरग्वा *murdhi*.
- (q) लाल केसर *lal kesar*.
- (r) सान जीरा *sam jira*.
- (s) सगा पक्षी *suga pankhi*.
- (t) सेल्हा *selha*.

976. In *Patna* the following are transplanted :—

- (a) बसग्वाती *basmatiya*.
- (b) सफेद *saphed*.
- (c) सिबाद् *siyah*.
- (d) सेल्हा *selha*.

977. In *South Munger* the following are transplanted :—

- (a) अनार कबी *andar kali*.
- (b) कजरी *kajri*.
- (c) कंचन पुर *kanchan pur*.
- (d) कारी बैंक *kari bank*.
- (e) गजग्वाती *gajpati*.
- (f) तुलसी फूल *tulsi phal*.
- (g) दौलती *dolgi*.
- (h) बांसग्वाती *basmati*.
- (i) मुरग्वा *murdhi*.
- (j) सिली चार *silli char*.
- (k) सेल्हा *selha*.

978. In South Bhagalpur the following are transplanted :—

- (a) कनक चूर *kanak chūr*.
- (b) कमोदी *kamodī* (a sweet-scented variety).
- (c) गोखुल चार *gokhul sār*.
- (d) दौना फूल *dauna phāl* (a sweet-scented variety).
- (e) बाग नर *bāg nar*.
- (f) बाँस फूल *bāns phāl*.
- (g) बाँसमती *bāsmatī*.
- (h) बासा पसिन *bāsa pasin*.
- (i) मनसरा *mansara*.
- (j) रामनिवा *ramaniya*.
- (k) राम दुलार *rām dullar*.
- (l) रामचा *ramcha*.

979. Of all the above rices, the most esteemed is बास जोरा *sām jira*. It is a fine kind, and when cooked its fragrance fills the house. The next best is बाँसमती *bāsmatī* or बसमतिवा *basmatiya*, which is not quite so fine as the first. सेहा *selha* may be considered as the third best.

C.—OTHER MISCELLANEOUS KINDS OF RICE.

980. बोरो *boro* is a poor kind of rice sown in Āsin (September–October) or Katik (October–November) in the mud on the banks of streams and lakes. It is transplanted several times in Pūs and Māgh (December, January, and February). लमेरा *lamera* or (in South-East Tirhut) जार *jhar* or in (Sāran) जारन *jhāran* is rice which has fallen from the sheaves when reaping, taken root, and grown next year.

981. *Rice-lands*.—Land which has been under a rice-crop is धनचर *dhanhar*, धनखेत *dhankhet*, or धनखेती *dhankheti*. It is also धनचर *dhanchar* in Shahabad, धनक्षिपारा *dhankhiyāra* in Gaya, and धनचा *dhancha* in Patna. Fresh waste land ploughed up for rice sowing is खिलमार *khilmār*; also नवाद खेत *nawād khet* north of the Ganges, and नौखील *naukhi* in Gaya. In the south-east it is खिलकट *khilkat* or खिलकही *khilkatti*. To dig it in order to make it fit for sowing is खील कोड़न *khil korāb* or खील तोड़न *khil torāb*. The preparation of a rice-field is कादो (or कदवा) करन *kādo* (or *kadwa*) *karāb*; also खेत करन *leo karāb* in

Saran, and मसाह करब *masah karab* in Champāran. A man who cultivates rice is धानवा *dhanha* to the west.

982. *Seedlings*.—A nursery for rice seedlings is बिहार *birār* or बिहार *biyār*. In South-West Shahabad it is बेंगा *benga*. The seed is बीचन *bihan*, बिचनार *bihnāi*, or बीचा *biya*, and the same words are also used for the seedlings of any crop; but the seedlings of rice are specially called मोरी *mori* south of the Ganges and to the west. They are also called जरई *jarai* in Champāran. The bundles of rice seedlings ready for transplanting are चाँदी *ānti* or अँटिया *antiya* north of the Ganges and in the south-east, and the quantity transplanted at one place is everywhere except to the south-east बाग *bān*. Seedlings of बोरो *boro* rice which have been transplanted once and are again transplanted are called in North-East Tirhut खार *khāru* or खरवान *kharuhān*. For fuller information concerning seedlings and transplanting, see 855 and ff.

CHAPTER V.—INDIAN CORN OR MAIZE.

983. Indian corn or maize (*zea mays*) is मकई *makai* or मकैया *makaiya*. It is also called जनेरा *janera* in the west and जिनीरा *jinora* in Patna, which names ought properly to be applied to the large millet (*holcus sorghum*). The stalks are डडा *dhattha* to the west and डडरा *thathera* to the north generally. In South Bhagalpur they are डडेरो *thathero*, and elsewhere दाँड *dānt* or दाँटी *dānti*. The broken stalk is लथेर *lathēr* in the North-West and West Tirhut, and निघास *nighās* or निघेसा *nighesa* in East Tirhut. No special name for this has been noted south of the Ganges.

984. When the grains begin to form, but are not yet fit for eating, the ear is called सचा *sancha*. The unripe ear is दुडा *duddha* to the west generally, and also दोषा *dodha* in Shahabad. Other names are खिचा *khichcha* or अजू *aju* in Tirhut, दुधगोहू *dudhghottu* in Gaya, दुडा मकई *duddha makai* in Saran and Patna, दुधभोरो *dudhbhoro* in South Bhagalpur, and दंतकमरा *dantkamra* in South Munger. When ripe it is हुडा *bhutta* or बास *bāl*. When the seeds are ripe and hard, and not fit for eating, it is called पकडाइल *pakthāil*. The roasted ear is चोरचा *horcha* generally, and also ओरचा *orcha* to the east. The empty cob after the grain is beaten out is लेंचा *lenrha* generally; also नेहा *nerha* in East Tirhut and लेंचुरी *lenruri* in Shahabad. In Patna and South-East Tirhut an optional name is बहुरी *baluri*, and South-East

Tirhut and South Munger **बहुरी** *bahri*. In South-West Shahabad the word used is **खुखुरी** *khukhuri* or **खोखरी** *khonkhri*, and in South Bhagalpur **हड्डी** *haddi*. The grain beaten out is **गोडा** *gota* or **गोट** *got*. An ear with no grain in it is called **भोरह** *borah* or **भोरहा** *borha* north of the Ganges. When it contains only a few grains it is called **पचगोडिया** *pachgotiya*. The hair on the ear is **घुआ** *bhūa* to the west; also **घुआ** *ghūa* in South-West Shahabad. In Champāran and Gaya it is called **सन** *san*. In Patna it is **मोच** *monchh*; in South Munger, **मोहा** *mochha*; in Tirhut and South Bhagalpur, **मोच** *moch* or **मोहा** *mocha*. It is also called **केसी** *kesi*. The sheath of the cob is **खोइया** *khoiyya* to the west, and **बलखोइया** *balkhoiyya* or **बोकहा** *bokla* generally. In Champāran another name is **खालखोइया** *khalchoiyya*, and in South-West Tirhut **बलको** *balko* or **कोसा** *kosa*. In East Tirhut it is **खोइया** *khoiycha*, in South Munger **पतौरा** *pataura*, and in South Bhagalpur **पोचो** *pocho*. The male ear is called **धनबाह** *dhanbāl* or **धनहरा** *dhanahra*.

CHAPTER VI.—THE LARGE MILLET.

985. Large millet (*halcus sorghum* or *sorghum vulgare*). **जनेर** *janer* or **जनेरा** *janera* generally. A variety of it is called **मसुरिया** *masuriya* *janer* to the west to distinguish it from maize (*sea mays*, see last chapter). So also it is called **नन्धिया** *nandhiya* *janera* in East Munger. Local names are **गहुमा** *gehuma* and **जोन्धरी** *jonhri* in Saran, **जिनोरा** *jinora* in Patna and Gaya, and **गहुमा** *gahuma* in South Bhagalpur. Amongst its varieties may be mentioned a large red kind grown in Shahabad, called **जोन्धरी** *jondhri*. This is called **सिसुआ** *sisua* *gahuma* in South Bhagalpur. A similar red kind is called **रक्खा** *raksa* or **रक्सी** *raksi*. This millet is little grown south of the Ganges. The only other kind noted there is **बाजरा** *bajra*, which is described as a dwarf white variety (see however § 987). North of the Ganges **दुधिया** *dudhiya*, or (in South Tirhut) **लार्कटिया** *larkatiya* or **नार्कटिया** *narkatiya*, is a dwarf white variety. The following also occur north of the Ganges:—**जलारिया** *jhalaria*, of which the head bends down, and which ripens late. **जेठी** *jethi* in the north-west is a kind sown for fodder. A kind with two grains in one husk is called **गेंडुआ** *genhuān*.

986. The stalks cut up for fodder are **धठेरा** *dhathera* or **धट्टा** *dhattha* to the west, and **धठेर** *thather* or **धठेरा** *thathera* to the east. When the

young plant first germinates it is **अंकुरा** *ankura*, and the young plant is **दिबि** *dibbi* or **दीबि** *dibhi*. The ears are **बाह** *bāl*, or in East Tirhut optionally **सिस** *sis*. The large stack of the stalks cut up for fodder is **गंज** *gānj* to the west and **तल** *tāl* to the east. Local names are **खम्हार** *khambhār* or **कांर** *kānr* in South-East Tirhut.

CHAPTER VII.—THE SMALL BULRUSH MILLET.

987. This millet (*holcus spicatus* or *pencillaria spicata*) is **बजरा** *bajra* in Sāran. South of the Ganges it is sometimes incorrectly called **मसुरिया जनेर** (or in Patna **जिनौरा**) *masuriya janer* (or in Patna *jinora*), which is properly a different grain, a variety of the large millet (*holcus sorghum*; see § 986). In South-West Shahabad it is **जोधरिया** *jondhariya*, and in South Bhagalpur **गहमा** *gahuma*. Just as the large millet is grown principally north of the Ganges, so this millet is grown almost entirely south of it. Hence there is great confusion in their names. The following terms relate exclusively to South Bihar:—The stalk is **दांत** *dānt* or **दांटी** *dānti* everywhere; also **दहा** *dhattha* in Shahabad and **थथेरो** *thathero* in South Bhagalpur. The first shoots of the plant are **अंखुआ** *ankhua* or **खुआ** *khua*; also **तिभिया** *tibhiya* in South Munger and **सुइया** *suiya* in South Bhagalpur. To throw out shoots is **अंखुआप** *ankhuāp* or **खुआप** *khūāp*. When the ear begins to show itself the phrase used is **ललहात बा** *lahāt ba* in Shahabad, **रेन्हा नेह है** *renra bhel hai* in Gaya, **ललहा राह है** *lahlahā rahā hai* in Patna, **आरा गेल** *ara gel* in South Munger, and **हलहालै** *halhalāichai* in South Bhagalpur. When the heads are blighted and grainless, they are **थुन्था** *thuntha* in South-West Shahabad; **बन्जरा** *banjhar* in the rest of that district and in West Tirhut, **बांर** *bānr* in Gaya, **थुत्था** *thuttha* in Patna, and **मुड़िया** *muriya* in the south-east. The fluffy flowers are **घोंपा** *ghompa* in South-West Shahabad, **जावा** *jāva* in South Munger, and **फुल्को** *phulko* in South Bhagalpur.

CHAPTER VIII.—THE SMALL MILLETS.

988. These are—

- (1) *Panicum Italicum*.—This is **तंगुनी** *tanguni* to the south-west and in Sāran, and **तांगुन** *tāngun* in Sāran and Gaya. Elsewhere it is **कांणी** *kauni*, or in South Munger optionally **काइन** *kāin*.

989. (2) *Panicum mileaceum*.—हाँवाँ *sāwāñ* or चावाँ *sāwāñ*. In Tirhut it is also चावा *sāma*, and in South Bhagalpur चावा *sama*.
990. (3) *Eleusine coracana*.—This is the most important of all the millets, forming the staple food of a large portion of the population. It is मरुवा *marua* or मँरुवा *manrua*. The empty dry ears after the grain has been taken out are हाँटी *dānti* north of the Ganges; also कटुवा *katua* in North-East Tirhut, मोदी *morhi* in South-East Tirhut, and पुती *putti* in South-West Tirhut. In South-West Shahabad they are खोल्ही *kholri*, and in the rest of that district भूसी *bhūsi*. In Patna and Gaya they are भूसा *bhūsa* or खाल्कोईया *khalkōiya*, and in the south-east they are भूसा *bhussa*. The stalks are नेरवा *nerua* or लेरवा *lerua* to the west, and लार *lār* to the north-east. Another word current to the north-west is धा *dhattha*. In Patna they are नार *nār*, in Gaya नारा *nāra*, and in the south-east लरवा *larua* or नरवा *narua*. In Gaya and the west हाँट *dānth* or हाँट *dānt* or हाँटी *dānti* is also used. The green ears roasted for food are उमी *ummi* or उमी *ūmi* to the west and in Tirhut, and उमी *ūni* in Champaran. When cut somewhat riper, but not quite ripe, and then roasted, they are खोरवा *horha* generally, and खोरवा *orha* in Tirhut and to the east. They are optionally खोल्हा *holha* in Champaran and South Munger. In Shahabad they are चापुस *hābus*, and south of the Ganges generally घुंघनी *ghunghni* or घुघनी *ghughni*. This being an important food-crop, there are many popular sayings concerning it. The following may be quoted:—

जब मरुवा चा के गाही भेल ।
 धिया पुता सुख सुख माही भेल ॥
 जब मरुवा मँ बास भेल ।
 धिया पुता के गाल भेल ॥

Jab marua a ke gāchhi bhel,
Dhiya puta sukh sukh māchhi bhel.
Jab marua meñ bāl bhel,
Dhiya puta ke gāl bhel.

—When the *marua* began to sprout, the children dried up like flies (*i.e.*, their food had been used for seed-grain); but when the *marua* came in the ear, the children got (fat) cheeks.

महुआ चीन चीन चक्र दही ।
 कोदो के भात दूध चक्र दही ॥
Marua min, chin sang dahi,
Kodo ke bhāt dūdh sang sahi.

—*Marua* should be taken with fish, *china* with tyre, and milk with *kodo*.

कोदो महुआ जन नहिं ।
 जोहना धुनिया जन नहिं ॥
Kodo marua an nahiñ,
Jolha Dhuniya jan nahiñ.

—*Kodo* and *marua* are not really food-grains, (*i.e.* they are despised as poor men's food), just as weavers and cotton-carders can never be cultivators.

991. (4) *Panicum frumentosum*.—This is चिन्ना *chinna* or चीना *china*, local variants being चीन *chin* in East Tirhut and चीन् *chinh* in South-West Shahabad. It is of two kinds in Sāran,—गौरिया *gauriya* and रकसा *raksa*. The grains when boiled and then parched are called माड़ा *mārha* or माँड़ा *mānrha*, or in East Tirhut माड़ *mār*.

992. (5) *Paspalum frumentaceum*—This is कोदो *kodo*. In Shahabad a smaller variety is called कोदर *kodār*.

993. *Miscellaneous*.—मकरा *makra* (*eleusine aegyptica*), a kind of grass of which the seeds are eaten. In the North-Western Provinces this name is applied to *eleusine coracana*, but not in Bihār.

CHAPTER IX.—PULSES.

994. Among the pulses are—

(1) *Cytisus Indicus* or *cajanus*.—This is राहर *rahar* or राहरी *rahri*. In North-East Tirhut it is also called रैहर *rāihar*, राहरि *rāhari*, or राहर *rāhar*. The dry stalks are रहेठा *rahetha*

north of the Ganges, or राहठ *rahath* or राहठ *rahath* in East Tirhut. South of the Ganges we have बरेठा *baretha* or ररेठा *raretha* (also used in Tirhut) in South-West Shahabad, राहरेठा *rahretha* in the rest of that district, राहरेठा *rahrath* in Patna and Gaya, लहरेठा *lahraitha* in South Munger, and लरेठो *laretho* in South Bhagalpur. The pods are डेकी *dehki* generally, and चेमो *chhemi* also north of the Ganges and in Shahabad. To the East they are also चीमरि *chimari* or चिमरि *chhimri*. In Gaya they are also चीमो *chhimi*, in Patna दिन्दी *dindi*, and in South Munger डीन्दी *dinri*. The stalks used for fodder are भूस *bhūs* or भूसा *bhūsa*; also कटुआ *katua* in Patna and कटुओ *katuo* in the south-east. This and other pulses when sprouting are known as दिबो *dibbi* or डीमो *dibbi*, except in the north-east, where they are गाह *gāhh*. Bread made from this pulse, gram (बूँट *bānt*), and *phaseolus mungo* (मुङ्ग *mung*), is called लिट्टी *litti* or रोटी *roti* north of the Ganges (both these words being general terms for bread made from any grain), बभरा *bhabhra* in Patna and Gaya, and चित्तावा *chittāwa* in South Munger. बरी *bari* is a kind of round cake or fritters made similarly.

995. (2) *Phaseolus mungo*.—This is मुङ्ग *mung* or मूंग *mūng*. In North-East Tirhut it is also called मँहा मूंग *mañha mūng*. The pods are called the same as those of *cytiscus cajanus* (राहर *rahar*). The stalks used for fodder are जेन्गरा *jhengra* in Saran, Gaya, and South-West Tirhut, जार *jhār* in Champāran and North-West Tirhut, दँड *dānth* in North-East Tirhut, and गाह *gāhh*, जमरि *jhamri*, or जॉंग *jhāng* in South-East Tirhut. South of the Ganges they are भूस *bhūs* or भूसा *bhūsa*; also कटुआ *katua* in Patna and कटुओ *katuo* in the south-east.
996. (3) *Phaseolus roxburghii* or *phaseolus radiatus*.—This is उरि *urid* or (south of the Ganges optionally) उरदी *urdi*. In East Tirhut it is also called कलार *kalāi*, करार *karāi*, or मास कलार *mās kalāi*. There are several kinds, e.g., डोमा *doma* (East Tirhut), which bears in *Pūs* and *Māgh* (January); लरि *larhi* (Sāran and South-West Tirhut), नरहु *narhu*, नरहो *narho*, लरहो *larho* or असनी *asni* (Tirhut), or अघनुआ *aghanua* (Sāran, Cham-

pāran), which bears in *Aghan* (November–December); तपखी *tepakhi* (Saran and South-West Tirhut) or कतिका *katika* (elsewhere north of the Ganges), which bears in *Kātik* (October–November); and भदखी *bhadvi* (South Munger), which bears in *Bhādoñ* (August–September). Another division is into black and green varieties. The black varieties are दङ्गा *danga* (North-East Tirhut), कारी *kāri*, करिया *kariya* (Shahabad and the south-east), काला *kāla* in Gaya, and सिदाह *siyāh* in Patna. The green kinds are तुलबुखी *tulbulli* in North-East Tirhut, हरियार *hariar* in Shahabad, हररा *harra* in Gaya, and सबखी *sabji* in Patna. The pods are डेंही *dhenrhi*, चेमी *chhemi*, &c., as above.

997. (4) *Phaseolus aconitifolius*.—This has only been noted south of the Ganges. It is generally called मोच *moth*. A smaller variety is मोची *mothi*. The stalks used for fodder are भूस *bhūs*, कटुआ *katua*, &c., as above.
998. (5) *Ervum hirsutum* (one variety) or *cicer* (or *vicia*) *lens* (another variety).—This is मसूर *masūr* or मसुरी *masuri*.
999. (6) *Miscellaneous*.—कुरखी *kurthi* (*dolichos biflorus*), खेसारी *khesāri* (*lathyrus sativa*),* भेंट *bhent* or भेंटवांस *bhent-wāns*, खेत मास *khet mās* or खेत मासु *khet māsu* (North-East Tirhut), which is apparently a variety of *phaseolus radiatus*, भिरंगी *bhirngi* (a kind of wild pulse eaten by the poor), and (Shahabad) लतरी *latri*.

* It is unwholesome for human beings, but bullocks eat it greedily, e.g., in the saying—

तुरक तारी, बैल खेसारी,
बामन आम, कायथ काम.

Turuk tāri, bail khesāri,
Bāman ām, Kāyath kām.

—Toddy is necessary for a Musalmān's happiness, *khesāri* for a bullock's, mangos for a Brahman's, and employment for a Kāyasth's.

CHAPTER X.—PEAS.

1000. Peas (*pisum sativum*) are of various kinds. The large variety is मटर *matar*, or in South-West Shahabad मडर *mantar*. A smaller variety is केराव *kerāo*. This is often sown with barley, when the mixed crop is known as जौ केराव *jau kerāi*, &c., see § 959. The principal varieties are कबिली *kabili* (north of the Ganges) or कबली *kabli* (south of it), which is a large white kind. It is also called घेबली *ghebli* in South-East Tirhut. North of the Ganges सुगवा *sugwa* is a small green variety. Another kind is known as बजरौ *bajri* in Champāran. बटुरी *baturi* in Shahabad, and कुचवी *kusahi* in Patna, Gaya, and the south-east, is a small black variety. In South Bhagalpur it is called भिठगरा *bhithgara*. Another variety is दबलिया *dabliya* in South-West Shahabad, डबल केराव *dabal kerāo* in the rest of that district, and धाबली *dhābli* in Patna.

1001. When the plant first appears above ground, it is called दिबो *dibbi* north of the Ganges and in Shahabad, but in the south-west of the latter district it is धाबो *dābhi*. In North-East Tirhut it is also called गाबो *gāchhi*. In Gaya and Tirhut it is अंकुरा *ankura*, in Patna and Tirhut अंकुवा *ankhua*, in South Munger कान्सी *kansi*, and in South Bhagalpur गजुर *gajur*. When the pod appears, the phrase is to the north of the Ganges पटा लागत वा *pata lāgat ba*, or a similar phrase. In South-East Tirhut they say that the plant is पटाएल *patāēl* or पटरा *patra*. In Shahabad they say it is गदराएल *gadrāēl*; in Gaya and South-West Shahabad they say डेंदी लागल है (or वा) *dhenrhi lāgal hai* (or *ba*); and in Patna दिन्दी लागल है *dindī lāgal hai*. The pod when fully formed is डेंदी *dhenrhi*, चीमी *chhimi*, चेमी *chhemi*, or चिमड़ी *chhimri* to the north, and दिन्दी *dindī* to the south. In South Bhagalpur it is डेंदी *dhenri*. The unripe pods are गाद *gād* or गादा *gāda*, and when used to make a pottage they are called बटकर *batkar* in South-West Shahabad. The young shoots are also used for pottage. These are called north of the Ganges साग *sāg* or भाजी *bhāji*, the latter principally to the west. When cooked to a soup it is called परेह *pareh*, and in Patna and Gaya जोर *jhor*. In South Munger they are चन्दा *chanda*, and in South Bhagalpur मटरौ साग *matro sāg*. The young shoots cooked with pulse are called दलपैता *dalpaita* in South-West Shahabad, and दलसग्गा *dalsagga* in Patna, Gaya, Saran, and the south-east.

CHAPTER XI.—GRAM.

1002. Gram (*cicer arietinum*) is **बूँट** *būnt* generally. It is also called **चना** *chana* in Sran, **बेदान** *bedām* in East Tirhut, and **रहिला** *rahila** to the west.

1003. **नोनी** *noni* or **खटार** *khatāi* is the oxalic acid and acetic acid which form on the leaves. In Shhababad **पीयर** *piyar* is a kind of which the grain is yellow pointed, and **बूँटी** *būnti*, or in Patna **चनी** *chani*, is a smaller variety. Another small variety is **बदुरी** *baturi* in Shhababad.

1004. The young shoot as it first appears above ground is said to be **सुरचार** *suiāi*. In East Tirhut they say of it **सूरि पेंकलकैक** *sūi phenkalkaik*. The shoot is called **दाब** *dābh* in South-West Shhababad, and **दिबो** *dibbi* in the rest of that district. In South Munger it is **दिबो** *tibbi*, and in South Bhagalpur **गजुर** *gajur* or **सा** *sā*. The young leaves used as pot-herbs are known as **साग** *sāg* or **भाजी** *bhaji*, the latter principally in the west. The pod is **धेंदी** *dhenrhi* generally, also **झीमी** *chhimi* north of the Ganges. Another name is **झीमड़ि** *chhimari* or **झिमरु** *chhimri* in East Tirhut. In Patna it is **दिन्दी** *dindi*, and so also in South Munger. In South Bhagalpur it is **धेंरु** *dhenri*, and in South-East Tirhut optionally **दिन्दी** *diñri*. The unripe pods are **कचरा** *kachra*, and elsewhere **कचरी** *kachri*. When the gram appears in the pod, the verb used is **गदराय** *gadraēb*. The plant is then called in South-West Shhababad **पटकी** *patki*, and in the rest of that district **चटकोहा** *chatkoha*. In Gaya the phrase is **चिटुरा लाग है** *chitura laḡal hai*,

* E.g. in the song—

रहि रहिला के पूरि कचौरी
रहि रहिला के दाब ।
रहि रहिला के कौनों खिरवरा,
बहुत मोटे गे गाब ॥

Ehi rahila ke pūri kachauri,
Ehi rahila ke dāl ;
Ehi rahila ke kauliñ khirawara,
Bahut motailen gāl.

—I made this gram into *pūri* (thin bread fried in clarified butter) and cakes into pottage *khirawara* (cakes of rice-flour prepared in hot water), and my cheeks got very fat.

and in Patna चट्टा धरिस है *chatta dharis hai*. The husk of the gram is बलुका *balukha* in South-East Tirhut; elsewhere it is हूसा *bhussa*, हूसा *bhūsa*, or बूसा *bhūsa*. Gram injured by rain is मरारल *marāil*, in Saran गलल *galal*. In Tirhut it is मारल गेल *māral gel*. South of the Ganges it is पतलग्गु *patlaggu* or पतलग्गुवा *patlagua*, except in South-West Shahabad, where it is उकठा *uktha*, in South Munger दहिवाण्ड *dahiyāṅḍ*, and in South Bhagalpur दगिवाण्ड *dagiyāṅḍ*.

CHAPTER XII.—SUGAR-CANE.

1005. Sugar-cane (*saccharum officinarum*) is known generally as अक *akh* or अकि *akhi*. In Tirhut, Patna, Gaya, and South-East Bihar a more general name is केतारी *ketāri*. In North-East Tirhut it is also known as कुसियार *khusiyār*. Among the varieties are—

कुसियार *kusihār* (south of Ganges), a dwarf hard variety.

केतार (Gaya and the south-east), केतार *ketāra* (Patna), केवाची *kewāchi* (Saran), केवाची *kewāchi* (Shahabad), रौंदा *raunda* (South Munger), a tall thin variety. Ripens in *Kātik* (October–November).

केवाची *kewāchi*,—see केतार *ketār*.

चिनिवा *chiniya* or चिनिवाँ *chiniyañ*, which is a soft, large, whitish cane. Good for eating in *Phāgun* or *Chait* (March). It is called पनसारी *pansāri* in Gaya and Shahabad, पनसाही *pansāhi* in Saran, and also पनसाही *panchhāhi* or पँसहिवा *pansahiya* in the south-west of that district and in West Tirhut. In South Bhagalpur it is called पौंड़ी *paunri*.

नरगोरी *nargori* (North Bihar),—see बरौंकी *baraunkhi*.

पचियारी *pachhiyāri*,—see पौंदा *ponrha*.

पनसाही *panchhāhi*, पनसारी *pansāri*, पनसाही *pansāhi*,—see चिनिवा *chiniya*.

पौंदा *ponrha* (west), पौंदा *ponra* (Patna and Gaya), पचियारी *pachhiyāri* (South Bhagalpur), a tall, stout, juicy variety.

पौंड़ी *paunri*,—see चिनिवा *chiniya*.

बरौंकी *baraunkhi* (Saran), बर अक *bar akh* (South-West Tirhut), or नरगोरी *nargori* (North Bihar generally). This is thin, with a reddish bark. The juice is sweet and thick.

सुरग्ली *bhurli* (North-West Bihar and West Tirhut), a very thick short cane, full of juice. Fit for eating in *Baisakh* (April-May).

मन्गो *mango*,—a small, hard, red cane.

रेंवड़ा *renwra* (North-West Bihar and South-West Shahabad) or सकरचीनी *sakarchini* (Patna and Gaya),—a yellowish kind, not good for eating.

रौंदा *raunda*,—see केतार *ketār*.

ललंगोड़ी *lalgonri*,—a tall, red variety.

सकरचीनी *sakarchini*,—see रेंवड़ा *renwra*.

साची *sahi* (South-West Tirhut),—a dwarf variety.

हथुनी *hathuni* (Saran and West Tirhut),—a moderately thick variety.

1006. A cane-field is to the west उर्बाँव *ukhāñw* or उर्बारी *ukhāri*. Elsewhere it is simply जख (or केतारी) के खेत *akh* (or *ketāri*) *ke khet*. Sugarcane land requires careful cultivation, or, as the saying runs, तीन पटावन, तेरह कोड़न *tin patāwan, terah koran*,—three waterings, thirteen hoeings. Land prepared for sugar-cane is उर्बाँव *ukhāñw* in North-West Bihar. When the land is left fallow the autumn preceding the planting, the plant is called पोड़ा *porha* in the North-West and in South-West Tirhut, and सुंगार *sungār* in North-West Tirhut. When an autumn crop is taken the season before planting the cane, the system is known as जरी *jari* to the west, or in Saran नारी *nāri*. In North-West Tirhut it is called दोतुरा *dotura*. South of the Ganges it is generally called चौमास *chaumās*. When cane is cultivated without irrigation, a layer of leaves, grass, &c., is thrown over the seed and acts as a sort of hotbed. This system is known as खदियाबोल *khadiyāöl* to the west and in South-West Tirhut, and गोषा पटावन *goa patāeb* in North-West Tirhut. To the west two ploughs are used in cane-planting. The first is simply called हर *har* or पहिया वाला हर *pahiya wāla har*; the second is called कान्ही के हर *kāñhi ke har* in Saran and बठौनी *bhathauni* in Champāran. The second plough has a bundle of grass tied round it, called कान्ही *kāñhi* or कान्नी *kāñni*, to widen the furrow. The furrow is everywhere सिरावर *sirāür*, also रेह *reh* in North-East Tirhut. South of the Ganges a second plough is not used. In Āzamghar the furrow is filled up by ploughing a second furrow alongside it, but in Bihar this is usually done by hand.

1007. The first watering of the cane is गन्दा धार *ganda dhār* in Gaya and South-West Shahabad; in the rest of Shahabad it is रेंवड़ा

chhenoka. In Patna it is पङ्गवा *panganda*, and in South Bhagalpur अँधरी पटावन *andhri patāwan*. Elsewhere it is simply पहिल पटावन *pahil patāwan*. The second watering is कोड़ा *kora* in Patna. Elsewhere it is दोसर पटावन or (पानी) *dosar patāwan* (or *pāni*), with a variant दोसरो पटावन *dosro patāwan* in South Bhagalpur. The third watering is चाँचरी *akhri* in Patna; elsewhere, तेसर (or तेसरो in South Bhagalpur) पटावन (or पानी) *tesar* (or *tesro*) *patāwan* (or *pāni*).

1008. Cane sprouting from the roots left since the previous season is known as खूँटी *khūnti* north of the Ganges, and also खुँटिया *khūntiya* in North-East Tirhut. When sprung from fresh seed it is known as बावन *bāwag*, or (optionally) in Tirhut रोप *rop*. Cane sown after the autumn crop is cut is known as जरिया के ऊँध *jariya ke ūkh* to the west, and also नारी के ऊँध *nāri ke ūkh* in Sāran. In South-West Tirhut it is दोतुरा के ऊँध *dotura ke ūkh*. Elsewhere it is known as चौमसिया *chaumasiya*. Cane cut up for seed is known as गेंडा *genra* or गेंडी *genri* to the west, and टोना *tona* or टोनी *toni* to the east. गुल्लि *gulli* is also used in Shahabad. In Patna it is also called पोंहड़ा *ponhra*, and in South Bhagalpur बीहन *bihan*. When only the top of the cane (which sprouts quicker than the rest) is cut up for seed, the pieces are called अँगेर *anger* in Sāran, अँगेरा *angenra* in Gaya, अगारी *agāri* in Patna, अग्रा *agra* in South Munger, and आगा *āga* in South Bhagalpur. North of the Ganges they are called बधिया *badhiya* or (in North-West Tirhut) फुन्गी *phungi*. The hole in which the cane slips are kept before planting is खाद *khād* in Sāran, खाना *khāta* in Champāran, गारा *gāra* in Shahabad, गंजसार *ganrsār* in Gaya, बलसार *balsār* in Patna, and टोन्खाद *tonkhād* or टोन्खावा *tonkhāwa* in the south-east.

1009. The sprouting eyes of the cane are आँखि *ankhi* or आँख *ankh* in Gaya and to the west generally; so also in South Munger. In North Tirhut they are अँखिया *ankhiya*, and in South-West Shahabad अँखवा *ankhwa*. In Patna and East Tirhut they are अँखुवा *ankhwa*, and in South Bhagalpur अँखियाव *ankhiyāv*. When just sprouted, the cane is called पुचारी *puāri* in Champāran, पौरी *pauri* in South-West Tirhut, and गोभी *gobhi* elsewhere north of the Ganges. In Shahabad it is called पोर *poi*, in Gaya it is said to be अँकुराएल *ankurāēl*, in Patna अँखुआएल *ankhuāēl*, and in Sāran सुरगाएल *suiyāēl*. In South Munger it is टिब्बी *tibbhi*, and in South Bhagalpur डिप्पी *dippi*. The earth is hoed (कोरल *koral*) once after the cane has sprouted. This is called पुचारी के जोत *puāri ke jot* in Champāran, and अन्हरिया *anhariya* in North-East Tirhut. Elsewhere it has no special name. The chief

hoeing is done in *Akhārā* (June–July), and is called *बसाही कोड़न* *akhārhi koran* or *बहरा के कोड़नी* *adra ke korni*. To the west it is called *बसाही कोड़* *asārhi kor*, and in Gaya it is *पासा pāsa*.

1010. The root is *जड़* or *खर jar* to the north-east, and *मूढ़* *mūrh* elsewhere north of the Ganges. In Shahabad it is *जड़ खर jar khar*, in Gaya and South Bhagalpur *खूँटी khūnti* or *खुँडिया khuntiya*, and in Patna and South Munger *जड़ी jari* or *जड़िया juriya*. When the sprouts are two or three feet high, they are called *तोंटा tonta* in Patna. Elsewhere they have no special name: the plant is simply described as *भर डेड़ना bhar thehuna*, or in some similar way. The knots on the cane are *पोर por*, and (in Shahabad) *पोड़ poi*. They are also called *गिरे gire* or *गिरेख gireh*. When these become visible, the plant is called *पोराना porāna* in Champāran, Patna, Gaya, and the east generally. In West Tirhut they are *गिहाना girhāna*, and in South-East Tirhut *पोर खोर्ना por chhorna*. In Shahabad they are called *डेड़ुका denrauika*. When the plant is ready for cutting, it is called *अगरबन्धु agarbandhu* in Patna and *अंगेरबन्धु angerbandhu* in Gaya. In the south-east it is *दाँड़ dānr*. Elsewhere it has no special name. A sprout of cane is *आँख ānkh* north of the Ganges and in Shahabad and Gaya. In North Tirhut it is *आँखिया ankhīya*, in Patna *आँखुआ ankhua*, in South Munger *कान्सी kansī*, and in South Bhagalpur *गोंधी gonjhi*. The leaves at the top and the upper part of the cane are *अगेर agenr* in the west, and *गेर genr* in the south-west of Shahabad. In Patna and Gaya they are *अंगेरी angēri*, and also *अगरा agra* in the latter district. In Tirhut they are *पगार pagār*, in East Tirhut *छीप chhīp*, and in the south-east *पगड़ा pagra*. The dry leaves at the top are *पतैन patain* in Sārān and South-East Tirhut, *पतखर pathar* in Champāran and North-West Tirhut, *पतखो patlo* in South-West Tirhut, and *पतखस patras* in North-East Tirhut. In Shahabad they are *पतई patāi*, in Gaya *पतौरा pataura*, in Patna *पतहूळ pathūl*, in South Munger *पतौरा pataura* or *पतखोळ pathol*, and in South Bhagalpur *पखणोर palhor*. Shoots coming from the knots are *कान्गोजर kangojar* or *कनोजर kanojar* in South-East Tirhut.

1011. A branch springing from the bottom and injuring the plant is *दोंज donj* in Sārān and South-West Tirhut, *पखकी pachhki* in Champāran, *फुटना phutna* in North-West Tirhut, and *गोभी gobhi* in East Tirhut. In South-West Shahabad it is *कान्की kankhi*, and in the rest of that district *गणुखा ganukha*. In Patna and Gaya it is *जोंका jonka*, and in the south-east *पगुरी paguri*. In South Bhagalpur

it is also पौंच *pahunch* or पोरोवो *porowō*. When a plant is attacked by insects, which are called in Sāran and Champāran सीना *sina* or तारा *tāra*, it is called north of the Ganges कानार *kandāl* or रसक *ratral*, or (in Tirhut) कना *kanah*. The latter name is also current in South-West Shahabad, and variants are कना *kandha* in South Munger, कानो *kāno* in South Bhagalpur, and काना *kāna* in Patna. In Gaya it is called रसाक *rasācī*, and another term in use in Patna is रसाक *rasācī*. North of the Ganges a plant is called मुड़ियारी नार *muryāri nārāl* when the top withers and fresh sprouts (टेनी *teni* in Sāran and दोजी *donji* in Tirhut) come out from underneath.

1012. The green top cut for fodder is अंग *agenr* or अंगेर *anger* in Sāran, गें *genr* in Champāran and Shahabad, अंगेरी *angeri* in Patna and Gaya, and also अग्र *agra* in the latter district, and अग *agār* in South Munger. In Tirhut it is पगर *pagār*, and in South Bhagalpur पग *pagra*. The piece between two knots cut for eating is पोर *por*. The piece of cane chewed at one time is गुला *gulla*, or (in Shahabad) optionally गुली *gulli*, and the refuse thrown out of the mouth खोया *khoiya* north of the Ganges. South of the Ganges it is generally खोया *khohiya* or चेपुआ *chepua*, local names being सिथी *sitthi* in Shahabad and South Munger, (also used in West Tirhut) and चोपा *chopa* in South Bhagalpur. For the pieces of cane cut for the sugar-mill, see § 288.

1013. A bundle of canes is पांजा *pānja*. A large bundle is बोधा *bojha*, which is as much as can be carried by a man.

1014. Among the *preparations of the sugar-cane* may be mentioned रस *ras*, or कचरस *kachras*, and in South Bhagalpur कचो रस *kancho ras*, which is the juice of the cane. When boiled down and undrained, it is राब *rāb* or (in Patna and Gaya) रावा *rāwa*. When boiled down for a longer time, it becomes गुर *gur* or गूर *gūr* (often spelt गुड़, गूड़). When made up in smallish balls it is called भेली *bheli*. Other names are मिठार *mithāi*, and, when made round and flat, चाकी *chāki* and चकरी *chakri* in Sāran, and चकी *chakki* in Patna and Gaya. The raw sugar which remains in the bag after pressing the *rāb* is called सकर *sakkar*, or in Patna, Gaya, and the south-east सकर *sankar*. When dried, it is called चाँड़ *khānr* or धुरा *dhurra* or भूरा *bhūra*, i.e. brown sugar. The molasses, or juice which runs out of the bag when the *rāb* is pressed, is called चोधा *chhoā*, or in South-West Shahabad सिरा *sira*. मिशरी *misri* is sugar-candy or loaf-sugar, and चिनी *chinūj* or चीनी *chini* is refined brown sugar (सकर *sakkar* or गूर *bhūra*): The molasses (चोधा *chhoā*) above

mentioned is used in tobacco manufacture, and is then called **तगार** *tagār* in Gaya, **गरिया** *gariya* in Patna, and **फाँक** *phānk* in South Bhagalpur.

1015. In a sugar-refinery **रस** *ras* (or in the north-west **सरबत** *sarbat*) is the raw sugar dissolved in water. **मैल** *mail* is the scum taken off the boiling-pans. To the south-east this is **मैला** *maila*, and in North-West Tirhut and Shahabad **महिवा** *mahiya*. The boiled juice is **सीरा** *sira*, and the clear filtered juice **रस के रस** *rās ke rās*. To the north-west the juice after the first filtering is **दोना** *doma*, and after the second **थोपारी** *thopāri*. When the scum is mixed with water and again boiled, it is called **पसावा** *pasāwa*.

CHAPTER XIII.—COTTON.

1016. The cotton-tree (*gossypium herbaceum*) is known everywhere except to the south-west as **बङ्गा** *bangā* or **बाँगा** *bāngā*, with a local variant **बाँगे** *bāngō* in South Bhagalpur. To the west it is called **कपास** *kapās*, which properly means the cotton in the pod. Most kinds of cotton ripen about *Baisākh* (April-May). Amongst the varieties may be noted **भोगिला** *bhogila* (north of the Ganges), a good kind with large pods, and of medium height; **भोचरी** *bhochri* (north of Ganges), a small variety, of which the cotton is apt to get blown out of the pod by the wind. **फेठवाह** *phetwāl* is a kind grown in North-West Tirhut, and **गाजर** *gājar* is one grown close to the house in the **बारी** *bāri*, and not in the fields, in North-East Tirhut and Shahabad; **रहिवा** *rarhiya* (Patna, Gaya, and the south-west), a dwarf variety; **बड़ैवा** *baraisa* (Patna and Gaya), a large variety; **सरमा** *larma* (Sāran), **नरमा** *narma* and **हैवती** *henwti* (Shahabad), a dwarf variety. Other kinds grown in Shahabad are **बाँरुछा** *bañrūchha* or **बाँरुछा** *bañrūchha*, and **मनुवाँ** *manuān*, and in Munger we find **गोला** *gola* and **सुपेद** *sūphed*. Tirhut is famous for a special kind of cotton which ripens in *Bhādoñ* (August-September), called **कोकटो** *kokti* or **भदैवा** *bhadaiya*, which is of a red colour, and of which thread and cloth of extreme fineness are made. A dress of *kokti* cloth lasts a life-time.

1017. The uncleaned cotton in the pod is **कपास** *kapās*, also **बाँगा** *bāngā* in East Tirhut, **बाँगे** *bāngō* in South Bhagalpur, and **काँच रूवा** *kānch rūa* in South Munger. To clean the seeds from cotton is **ओटाव** *otab* or **ओँटाव** *ontab*, and the operation is called

चोट्टी *otni* or चोगट् *otāi* in Saran, and चोडार *auntāi* in South Bhagalpur. The last two words also mean the wages paid for cleaning. The cotton-pod is called डेंड *dhenrh* to the north-west and डेंही *dhenrhi* in Tirhut and South Bhagalpur. In Shahabad it is डोंही *dhonrhi*, in Gaya डेर *ter*, in Patna and South Munger डिन्ही *dindi* or डोंही *dinri*. The cotton-seed is बनौर *banaur* to the west, बंगौर *bangaur* in Tirhut, बंगौरा *bangaura* in South Munger, and बंग्ठी *bangthi* in South Bhagalpur. In South-West Shahabad it is बंदौर *bandaur*. A cotton-picker is लोह-निहार *lorhnihar* (which means simply 'gatherer') in the north-west; elsewhere there is no special name. North of the Ganges he or she is paid by a share of the cotton picked. This is called पर *par* in Saran and South-West Tirhut, पोर *poi* in South-East Tirhut, and बोरन *boin* in North-East Tirhut. In North-West Tirhut the share is a fourth of the crop, and is called चौडेवा *chauthiya*.

1018. The stages of growth in the plant are as follows :—

When the first leaf shows, it is called पतिबाण्ड *patiyāel* north of the Ganges. In South-West Shahabad it is डुब्ही *dubbi*, in the rest of that district डिब्ही *dibbi*, and in Patna and Gaya कनिबाण्ड *kaniyāel*.

The next stage is दोपतिबा *dopatiya* to the north-west, and also south of the Ganges generally. In Tirhut they say it is कपारी फोरल *kapāri phoral*. In Gaya it is पतिबा *patiya*, in South Munger दोपती *dopatti*, and in South Bhagalpur दुपतिबो *dupatiyo*.

The third stage is चौपतिबा *chaupatiya* or (to the north) चरपतिबा *charpatiya*, and in South Bhagalpur चरपतिबो *charpatiyo*.

The flower has no special name, and is simply called फूल *phul*. To flower is फुलाण्ड *phulāeb*.

The pod bursting is कपास फूटब *kapās phūtab* to the west, and in East Tirhut बांग फूटब *bānga phūtab*. In South Bhagalpur it is बांगो फूटब *bāngo phūtab*, and in South Munger फोटा *phota*.

1019. Raw cotton is कपास *kapās*, or बांग *bānga*, बांगो *bāngo*, &c., as above. In East Tirhut बांग *bāng* is also used. To the west बांग *bānga* means cotton stalks. From रडिबा *rarhiya* (raw cotton) about one-sixth clean cotton is obtained; from भोचरी *bhochri* and कोकडी *kokti*, about a quarter; from भोजिबा *bhogila* and हेंवती *henoti*, about a third; and from फेटवाल *phetwal*, about two-fifths. मिह्रा *mijhra* north of the Ganges is a mixture of भोचरी *bhochri* and भोजिबा *bhogila*.

1020. Cotton is the subject of many proverbs, as (for instance) South Munger proverb जेकरा बारड पिगडा बांग, कसर में डोरो ना, *jekra*

bārah bigha bāng, kamar meñ dorō na—(here's a fine miser) he has twelve *bighas* of cotton and can't afford a string for his waist.

CHAPTER XIV.—TOBACCO.

1021. Tobacco (*nicotiana tobacum*) is तमाकु *tamāku* or तमाकुल *tamākul*. It is little grown south of the Ganges except in South-Bhagalpur and South Munger. North of the Ganges there are three main classes:—

- (1) देसी *desi* or (North-East Tirhut) बड़की *barki*.
- (2) बिलायती *bilāēti* or (in Champaran and North-West Tirhut) कलकतिया *kalkatiya*.
- (3) जेठवा *jethua*, which is sown in *Magh* (January–February) and out in *Jeth* (May–June).

In East Bihar are found धमाकुल *dhamākul*, a broad-leaved variety, and पानडठिया *pandathiya* and खंगरीवा *khangriwa*, narrow-leaved varieties.

1022. In Shahabad मोरहन *morhan* are long leaves of the best kind, and चेषवा *chheva* the next quality.

1023. When manufactured, there are three main kinds:—

- (a) *Chewing-tobacco*.—खैनी *khaini* or सुरती *surti*, or in Patna दोखता *dokhta*. Some people call this कल जुग के अन्नित *kal jug ke anrit*, or the ambrosia of the *kali* age.
- (b) *Snuff*, which is नास *nās* or नस *nas*.
- (c) *Smoking-tobacco*.—This is called पीपनि *piani* or पीनी *pini* generally. Among its kinds may be noticed काला *kāla* (North-West and South-East Tirhut) or पकुवा *pakua* (Tirhut), which is the coarsest kind. कन्दर *kandar* or बसुना *bhusna* in South Bhagalpur, and गूरी *gūri* in South Munger, is broken tobacco. करुवा *karua* or (in South Bhagalpur) करुवो *karuo* is a second-class strong kind. दोरसा *dorassa*, or in South Bhagalpur दोरसो *dorasso*, is a mixed tobacco of fair quality. Another similar kind is called मसालदार *masāldār* or मसकौषा *mahkaua*. खमीरा *khamira* is a scented kind mixed with spices, and सदा *sāda* is the plain kind in common use. मलुवा *malua* to the west is the usual kind sold in

shops, and *दोकानी dokāni* is the cheap kind used by the poor.

1024. The stalks are *दन्ती danti* generally, with local variants *दाँट dānt* in South Munger and *दाँटकी dāntki* in South Bhagalpur. In East Tirhut they are also *दाँट dānt̃h*. The refuse broken leaves and stalks are *जाहा jhāla* in the south-east, and in South-East Tirhut *खरसाब kharsān*. When blisters come on the leaf when ripe, the verb used is *चढ़ चढ़ chāṛhāḥ*; also *गुलथियाग्र gulthiyāḡḥ* or *चितियाग्र chitiyāḡḥ* in Champāran. The blisters themselves are called *चिनी chitti*. The seed-capsules are *घुनी ghūni* in Sāran, *फर phar* in Champāran, and *बिची bichchi* in Tirhut generally. The nipping or cutting off of the head is *पता मूर पता तराब pata tarāb* in Sāran and South-West Tirhut, *चोपनी chhopni* in South-East Tirhut, and *काटब kātab* or *काटनी katni* elsewhere. Sometimes shoots appear after doing this, and they are called *दोजी donji*. Other local names are *पचकी pachkhi* in Sāran and Champāran, *कनोजर kanōjar* in North-East Tirhut, *कनेल kanail* or *काँकी kānki* in South Tirhut, and *कनई kanai* in the east generally. The first crop is called *मोरचम morhan*. A second crop raised from the roots is *दोजी donji*, or in South Bhagalpur *खुंटिया khuntiya*. Tobacco seedlings are called *पोषा poa* in South Bhagalpur.

1025. Tobacco is the subject of many proverbs and tales. An example of the former is—

चून् तमाकु साब के, बिन् मंगे जे दे ।
 सुरपुर नरपुर नामपुर, तीन् बस कर के ॥
Chūn tamāku sān ke bin mānge je de,
Surpur narpur nāgpur, tīn bas kar ke ॥

—The man who mixes tobacco with lime (for chewing) and offers it without being asked, conquers (by his virtuous action) heaven, earth, and the lower regions.

1026. A folk-tale about tobacco runs that a villager who went to a distant village to visit his friends found them smoking in the morning before they had said prayers, whereupon he said—

भोर भए नहुस सभ जागे ।
 हुक्का चिलम बाजम लागे ॥
Bhor bhāe, manus sabh jāge,
Hukka chilam bājan lāge.

—At daybreak the people awoke, and immediately the *hukkas* began to gurgle.

To which one of the smoking party replied—

खैनी खार नः तमाकु पीए ।

से नर बनावः कैसे जीए ॥

Khaini khāe, na tamāku piē,

Se nar batāwa kaise jiē.

—Show me the man who can live without either chewing or smoking tobacco. This verse has passed into a proverb.

1027. Tobacco is often compared to the river Ganges, which has three streams,—one of which flows to heaven, another to hell, and the third to the world of mortals. So also tobacco has three branches, viz. snuff, which, by being smelt, goes upwards; smoking-tobacco, which, by being smoked, goes downwards; and chewing-tobacco, which goes neither up nor down.

CHAPTER XV.—OPIUM POPPY.

1028. Opium poppy (*papaver somniferum*) is पोसना *posta* or (in Patna) पोसत *posat*. The advances made to the cultivators are दारनी *dādni*. The average produce per *bigha* is सरदार परतार *sardar partar* or परता *parta* north of the Ganges and in Gaya. In Shahabad it is मास *māl*, and in Patna पैदा *paida*. The rough measurement of the field is लहाबन्दी *lathābandi* in South-West Shahabad, and elsewhere south of the Ganges नाप *nāp*. North of the Ganges it is नापी *nāpi*.

1029. The poppy petals are फूल *phūl*, and the heads देही *denrhi*, or in Patna दिन्दी *dindi*. The cakes of poppy petals are फुलपता *phulpata* in Champāran, फुलपत्ती *phulpatti* in Sāran and Tirhut, and पत्तल *pattal* in Patna. Elsewhere they are रोटी *roti*.

1030. The instrument used for piercing the capsule is नहरनी *naharni*, or in Tirhut optionally लहरनी *laharni*. In Patna and Gaya it is नरहनी *narhanni*. To lance the capsule is पाहब *pāchhab*. The milky juice which exudes is दूध *dūdh*, and the opium yield is मास *māl*. The scraper used for collecting the coagulated opium off the pod is called सितुहा *situha* or सितुहा *situa*. In South-East Tirhut sometimes a bamboo scraper is used, called पोहनी *pochhni*. The gathering of opium is उठाव *uthāēb* generally. Local words are काहब *kāchhab* to the north-west and in North-West Tirhut, and पोहब *pochhbab*

also in North-West Tirhut. The person who lances the capsules is *पक्ष्मिहार pachhmihār* or (*fem.*) *पक्ष्मिहारिन pachhmihārin*, and he or she who collects the coagulated opium which has exuded from the capsule is *उथौमिहार uthaumihār* or *उथौमिहारिन uthaumihārin*. The grain of the prepared opium is *दाना dāna*, and its consistency *सुखन्वन sukhwan*.

1031. The grains of opium-seed are *दाना dāna*. The shell is *खोरवा khoyya* north of the Ganges, and *खोदिया khohiya* in Gaya. In South-West Shahabad it is *खोलन्दी kholri*, in the rest of that district and in South-East Bihar *बोकला bokla*, and in Patna *बकुला bakula*. In Gaya *चिटुरा chitura* are poppy capsules which are empty and have not borne seeds. The oil-cake prepared from the seeds is *पिन्ना pinna* or *पीना pina*.

1032. The refuse opium, consisting of the washing of the vessels, &c., is *धोवन dhoan* north of the Ganges and *धोई dhoi* south of it. In the south-east it is *धोए dhoe*. The refuse scraped from the vessels is *खुरन्चन khurchan*, or (Gaya, South-West Shahabad, and South Munger) *खखोरन khakhoran*. The juice which drains off the fresh opium is *पसेवा paseva*. This is inspissated on rags, and the product is *कफा kapha*, of which *काफा kāpha* in Shahabad and *कप्पा kappha* in Saran and South Munger are local variants. The fluid opium used in pasting the leaves on the cakes is *लेवा lewa* in Patna, and the cakes themselves are *गोटी goti*.

1033. *Preparations of opium.*—*मदक madak* is made by boiling down and inspissating the juice (*अरक arakh*) of pure opium or *कफा kapha*. This inspissated juice is known as *किमान kimām* or (in Gaya) *केमान kemām*. With it are mixed cut-up betel or guava leaves, known as *जासु jāsu*. The pipe used for smoking *madak* is known as *मरु मरु mahru* or *ठरिया thariya* or *ठरिया tharhiya*, or to the south-east *मेरु meru*. A small piece of *madak*, known as *छीटा chhita*, is ignited in the bowl of the pipe with a spill of charcoal, called *कलम kalam* or (in South Bhagalpur) *कंगड़ा kangra*, which is held by a small pair of tongs, called *चिमटा chimta* in the north-west and *चूँटी chūnti* south of the Ganges.

1034. *चन्दू chandū* or *चौँदू chāndū* is the distilled juice of pure opium, and is smoked in an earthen bowl called *चिलम chilam* to the north-west and *दवात dawāt* south of the Ganges. This is attached to a stem called *निगाली nigālī* in Saran, Patna, and Gaya, *नरचा narcha* in Champāran, and *नर nar* in North-West Tirhut. Another name is *बम्बू bambū* or *बाँबू bāmbū*, bamboo. It is stirred with an iron skewer, called *थक thak*.

When it is desired to make the preparation extra strong, the sediment which accumulates in the stem of the pipe is added. This is called **अची** *anchi* south of the Ganges generally, **इन्सी** *insi* in South Munger, and **इन्ची** *inchi* in South Bhagalpur. In Patna it is also called **कैटी** *kaiti*, and in Champaran **कैटी** *kaiti*.

1035. **पिनिक** *pinik* is the drowsiness produced by opium intoxication, and **चुस्की** *chuski* the quantity of opium water drunk at one time.

CHAPTER XVI.—HEMP.

1036. The hemp plant (*cannabis sativa*) is known as **गंजा** *ganja* when cultivated in Rajshahai, and **भंग** *bhang* when wild elsewhere. The leaves are known as **भंग** *bhang* or **भङ्ग** *bhang* (generally), **सबुजी** *sabuji* (north-west), or **सबजा** *sabja* (Patna and Gaya). A favourite way of taking the drug is in the form of a sweetmeat, called **मजूम** *majum* or **माजूम** *majum*. **चरस** *charas* is the resin which exudes from the flowers and leaves.

1037. The flat *ganja* is **चपटा** *chapta* or **चिपटा** *chipta*; also in Shahabad **कली** *kali*. The round *ganja* is **गोल** *gol*, also **गिरगिटिया** *girgitiya* in South-West Shahabad, and also **पमरि** *pamri* in the rest of that district. Broken *ganja* is **रोरा** *rora* or **चूर** *chur*, or (in Gaya and South Munger) **रै** *rai*. In Shahabad **बालूचर** *baluchar* and **जासर** *jasar* are two kinds of imported *ganja*. *Ganja* with stalks attached is called **दरही** *darhi* in Shahabad. **मेदनि** *medani* or **मेदनी** *medni* is a plant taken with *ganja*.

CHAPTER XVII.—INDIGO.

1038. Indigo (*indigofera tinctoria*) is **लील** *lil*. The word **नील** *nil* used by Europeans is a Westernism borrowed from Urdu-knowing subordinates.

1039. Indigo sown before the rains and irrigated by artificial means is called **पटौषा** *pataua*. The first cutting is **मोरहन** *morhan*. The second cutting is **खूँटी** *khūnti* or (in South-East Tirhut) **दोंजी** *donji*, and the third cutting is called **तेजी** *tenji* or **तेहरै** *tehrī*, or in the north-west **तिरंटी** *tirānti*. If the second or third cutting is allowed to grow on to the second year it is called **कलम** *kalam* or **कल्मी** *kalmi*. In South Bhagalpur there are two sowings (**बावग** *bāwag*),—one called **कतिनी**

katiki (कतिक् *Katik* = October–November), and the other *phalguni* (फाल्गुन *Phalgun* = February–March). In North Bihar the chief sowing is the *phaguni* (फागुन *Phagun* = February–March), and there is a second sowing in *Akhārī* (अखारि June–July), called *asārhi* or *akhārhi*. There are also sowings in *Katik* (October–November) and *Baisākh* (April–May).

1040. The system of obtaining the plant from cultivators on advances is called *dādni* or *dādan* in the north-west, in South-West Tirhut, and in South Bhagalpur. When indigo is grown by cultivators who have entered into an agreement to do so, it is called *raiyaṭi* or *asāmiwār* or *asāmiyār*. Under the system called in the north-west *khush kharid*, the planter advances money to a cultivator to sow indigo. He also advances indigo-seed at a given rate, the price of which is recovered in the settlement of accounts. This is also called *khushi* in Champaran and *navishtakhāni* in North-West Tirhut. *thika ke lil* is when the planter takes a village in farm and cultivates the *sira'ats* (जिरात *jirāt*) and such other land as he can secure. The special cultivation carried out by the planters themselves is *jirāt*, or (in South Bhagalpur) *bāri*. The divisions of their estates are called *jila*, each under charge of a *jiladār*, and a subdivision is (north of the Ganges) *tōk*, under charge of a *tōkdār*.

1041. *alāwa* or *alāwe* is indigo grown by the cultivator on his land after opium or other crop.

CHAPTER XVIII.—OTHER DYES.

1042. The following may be noted:—

(1) *āl* (*morinda citrifolia*).—This is used for dyeing red cotton cloth *ālu* and the coarse red cloth *khāruān*. The root is divided into classes, called *bana*. The best and thinnest roots are known as *phāha*. The thickest roots are *kachri* in Shahabad and South Munger, and *toran* or *gulli* in Patna and Gaya. *mel* in Shahabad is a mixture of the two kinds.

1043. (2) *Safflower* (*carthamus tinctorius*).—This is *kusum* generally north of the Ganges, and *kosum* south

of it. A local name is *फूल phul* in Tirhut. The seed is *बररी barri* in South Munger. It is also called to the west and in Patna and Gaya *बररी barre*. The following are some of the colours prepared from safflower:—

- असमानी *asmāni*, light blue.
- कानी *kāgi*, navy blue.
- काला *kāla*, black.
- काहि सबुजा *kāhi sabuja*, dark green.
- केसरिया *kesariya*, saffron-yellow.
- गुलाब *gulāb* or गुलाबी *gulābi*, pink.
- चंपई *champi*, orange.
- नारंगी *nāranji*, orange yellow.
- पेठानी *paithāni*. Made by dipping into an indigo-vat also.
- फाल्साही *phālsāhi*, plum-coloured.
- बदामी *badāmi* or बेदामी *bedāmi*, almond-coloured.
- बैंगनी *baingni*, purple.
- मासी *māsi*, a very dark green.
- लाल *lāl*, red.
- लीला *līla*, dark-blue.
- सबुजा *sabuja*, green.
- सुरमई *surmai*, antimony-black.
- सुरख *surukh*, red.
- सोनहूला *sonāhula*, golden yellow.

Of course all the above are not made from safflower alone, but it forms the basis of all. In most of the darker colours it is used in conjunction with indigo. The following riddle shows the comprehensive range of colours embraced by safflower. At a marriage procession garments of every bright colour are worn, and the riddle is—

बाप रबल पेठे, पूत गेह बरियात.
Bāp rahal pete, pūt gel bariyāt.

—While the father was still in the womb (*i.e.*, pod), the son went to a wedding party. The father is the seed of the safflower in pod; the son is the safflower dye.

In the north-west *जरुआ तेल jarua tel* is an oil extracted by means of heat from the safflower-seeds. It is called *जरदुआ तेल jarathua tel*, and in Shahabad *दरुआ तेल darhua tel*. It is used for applying to sores, and also for burning.

1044. (3) बकम *bakam* (*caesalpinia sappan*).—This is a red dye, used principally where बाह *di* is not obtainable.

CHAPTER XIX.—OILSEEDS.

1045. Oilseeds in general are चिकना *chikna*, तेहनन नीची *telhan tsi*, or simply तेहनन *telhan*. Amongst the varieties may be noted—

- (1) *Mustard* (*brassica campestris* or *sinapis dichotoma*).—This is सरिचो *sarison* or सरिचो *sariso* north of the Ganges and in the south-west; elsewhere it is सरचो *sarson*. In South Bhagalpur it is गोडो *goto*, and in North-East Tirhut also गोड *got*. Oil from this seed is called करवा तेल *karua tel* or कर तेल *karu tel*.
- (2) *Mustard* (*brassica juncea* or *sinapis ramosa*).—This is लही *lahi* or रार *rāi* to the west. In South Munger it is रची *ranchi*, and in East Tirhut रैची *rainchi*. Elsewhere it is तोरी *tori*, and so also in Champaran.
- (3) *Sesamum* (*sesamum orientale* or *Indicum*).—This is नीच *til*. In South-West Shahabad तिली *tilli* is a variety with a white grain, which is sown with the autumn crop.
- (4) *Linseed* (*linum usitatissimum*).—This is नीची *tsi*. To the east it is also called चिकना *chikna*.
- (5) *Safflower* (*carthamus tinctoria*).—See last chapter.
- (6) *Castor-oil plant* (*ricinus communis*).—This is रेंर *renr* or रेंर *lenr*, also अरर *anrar* in the north-west, Tirhut, and South Bhagalpur, and अदा *anda* in Tirhut and South Bhagalpur. The seed is लैरी *lāri* or रैरी *refri* generally, also अररी *anrri* in the north-west, Tirhut, and South Bhagalpur, and अदी *andi* in Tirhut and South Bhagalpur. A plantation of this is रेंरवारी *renrwāri* or लैरवारी *lenrwāri*.
- (7) *Bassia latifolia*.—The tree is called महु *mahu* or महुवा *mahua*. Its clusters of buds are चहा *chhatta* or कोंच *konch*. The flower which falls to the ground and is used for distilling spirits is महु *mahu* or महुवा. The oilnuts which are borne by the tree are कोइन *koin* north of the Ganges, or कोइनी *koini* in South-East Tirhut. In South-West Shahabad they are कोइदा *koinda*. In South Munger the *mahua*-pickers sing a song while employed, called तोहा *toha*.

- (8) *Celastrus paniculatus*.—This is मलकङ्गनी *malkangni* or डिठौरी *dithauri* in South-West Shahabad, मलकौनी *malkauni* in Patna and Gaya, मलकौनी *mankauni* in South-East Tirhut, कौनी *kauni* in South Munger.
- (9) *Croton (croton tiglium)*.—This is जमाल गोटा *jamal gota* in Patna, Gaya, and the west.
- (10) Two other oils may be mentioned here. One is मिमिदा के तेल *mimiyāi ke tel*, which is supposed to be extracted from the heads of coolie emigrants to the colonies, by hanging them head downwards over a slow fire, see §1464. The other is अकोल के तेल *akol ke tel*, made from the nut of the अकोल *akol (aleuritis triloba)* tree, which if rubbed on a person's body makes him invisible. This is like saying that if you catch a guinea pig by the tail his eyes will drop out; for the nut is so hard that it is impossible to extract oil from it.

CHAPTER XX.—FIBRES.

1046. *Hemp, as a drug (cannabis sativa)*.—See Chapter XVI.

1047. *Hemp, as a fibre plant*.—There are two varieties of this:—

- (1) सन *san (crotolaria juncea)* or (North-East Tirhut) कश्मिरा *kasmira* or सोन *son*.
- (2) पटुषा *patua*, कुतुरम *kuturum*, or (in South Bhagalpur) कुदरम *kudrum (hibiscus cannabensis, Roxb.)* This is like *san*, except that its flower is like the safflower, and that it is used only for making the coarse fibre (चना *channa*). See below.

1048. The stalk is सनई *sanai* north of the Ganges generally except in North-East Tirhut, where it is सनै *sanai*. In Shahabad it is सनैठा *sanait̥ha*, in South Munger सनाठी *sanāthi*, and in South Bhagalpur सनसनाठी *sansanāthi*. When the bark has been removed, it is सन्धी *santhi*, or in South Munger सनाठी *sanāthi*, and in South Bhagalpur सनसनाठी *sansanāthi*. A bundle of fibres is लरन्हा *larchha*, or in East Tirhut धोषा *dhosa* or धूषा *thūa*. Short stalks that remain in the fibre are called in North-East Tirhut गुदरी *gudri*, खुदर *khudar* to the west and in West Tirhut, कुदारी *kudari* in North-East Tirhut,

and गुदर *gudar* in East Tirhut. In North-East Tirhut the coarsest fibres are called चन्ना *channa*, the next finest पटुचा *patua*, and the finest कश्मिरा *kasmira*. There is no special name for the seed.

CHAPTER XXI.—BETEL.

1049. Betel (*piper betel*) is called पाव *pān*, and the man who grows it बरई *barai*. Amongst its varieties the best is कपूरी *kapūri*, which has a long leaf, mild, but slightly bitter. The next best is साँची *sānchi*. The common varieties are ककौर *kakir* (North-East Tirhut) or ककेर *kaker* (South-East Tirhut), which has a large leaf and mild flavour; the बेलहरि *belahri* (south-west) or बेलहरि साँची *belahri sānchi* (North-East Tirhut), and the मगही *maghi*, which have a round leaf and a sweet taste; and the बंगला *bangla* or (South-West Tirhut) बंगरा *bangra*, which is small and slightly bitter. To the west there is also a kind called करवा *karāva*, which is small and sweet.

1050. The mound on which the plant is grown is भिन्दा *bhinda*, बरेठा *baraiṭha*, or पाद *pārḥ* north of the Ganges. South of the Ganges it is भौट *bhit*. A betel-garden is बरेव *baroe* or बरवे *barve*. The rows in the plantation are सपुरा *sapura* in Saran and South Tirhut, and साँपुर *sāmpur* in North-East Tirhut. In South-West Shahabad they are पास *pās*, and in the rest of that district पाँती *pānti*. The intervening spaces are आंतर *antar* or अंतरा *antra*. They are also पाहे *pāhe* in South-East Tirhut, दौंगर *daungar* in Patna and Gaya, and दौग *daug* in the south-east. The main props down these lines are कोरो *koro* in Tirhut and कोरई *korai* in Shahabad. In the south-east and in Saran they are इकरी *ikri*.

1051. The spaces between these props are in North-East Tirhut कोरवाच *korvāc*. The supports of the plants are सरई *sarai* north of the Ganges, or in South-East Tirhut खरही *kharhi*, of which there are generally six between each main prop. In Shahabad they are called इंकर *inkar*, and in the south-east सरकंधा *sarkanda*. In Shahabad धेंपी *dhempi* are the lumps of clay in which the plants are sown. The supports of the roof are also कोरो *kōro*, except in Patna and Gaya, where they are कम्भा *khambha*, and in South Munger, where they are खम्बी *khāmbi*. The walls are तट्टी *tatti*, or in East Tirhut टाट *tāt*, and in East Munger टाटी *tāti*. The roof is मारु *māro* or मारु *mānro*. In South-East Tirhut it is optionally मारु *mārab*. In South-West Tirhut

it is डडर्रा *thatra*, and in Shahabad and East Tirhut optionally चानी *chhani*. In South Munger it is मडर्रा *marwa* or डडर्री *thathri*.

1052. The brushwood on the top is करई *kharai* or (in South-West Shahabad) खरचा *kharcha*, and in South Munger कचुआ *kachua*. The young seedlings for planting are कलम *kalam* in Patna, Gaya, and Shahabad, and बेल *bel* elsewhere. They are watered from an earthen vessel called लोटी *loti* or (in Saran) लोट *lot*. In North-East Tirhut मडोर *mator* is a basket in which the gardener carries earth to the plant, and which he also uses for keeping the leaves. In East Tirhut भूर *bhūr*, and in South Tirhut भूरा *bhūra*, are the shoots which come out of the plant near the root in Jeth (May-June), and कन *kan* are those which come out in Bhadon (August-September).

1053. A packet of twenty leaves is called a कोरी *kori* south of the Ganges. North of the Ganges one of fifty leaves is called चौडेया *chauthaiya*, and one of a hundred leaves चाथा डोली *adha dholi*. A डोली *dholi* has 200 leaves.

1054. North of the Ganges and in Shahabad—

| | | |
|---------------------|---|---|
| 7 डोली <i>dholi</i> | = | 1 कनसाँ <i>kanwān</i> . |
| 14 ditto | = | 1 अधवा <i>adhwa</i> . |
| 28 ditto | = | 1 पौआ <i>paua</i> or पावा <i>pāwa</i> . |
| 4 पौआ <i>paua</i> | = | 1 लेसो <i>leso</i> . |

1055. Elsewhere south of the Ganges 108 डोली *dholi* make 1 लेसो *leso*. A leaf of betel rolled up in a cone for chewing is बीड़ा *bira*, बिरवा *birwa*, or बिरिया *biriya* or बिछी *khilli*. It is also गिलौरी *gilauri*. सिंघारा *singhāra* are the triangular-shaped packets. Betel is kept for consumption in a wickerwork basket, called बेलहरा *belahra* or (in East Tirhut) बिरहरा *birahra*. In North-East Tirhut धाकी *dhaki* is a large basket used by the betel-grower for the same purpose.

1056. The betel-nut, which is the fruit of the *areca catechu*, is called सुपारी *supāri* or सोपारी *sopāri*. Other names are कसेली *kasaili* north of the Ganges, and मुकसुध *mukhsudh*, मुकसुधि or मुकसुधी *mukhsudhi*, in East Tirhut. The nippers for cutting the nut are सरौता *sarauta*. A well-known proverb is मुकसुधि न० परकार, तनिका अरियातक न० चमकार *mukhsudhi na parkār, tanika ariyātak bar chamatkār*,—he can't afford to give his guest even a bit of betel-nut, and yet he escorts him out of the house with as great pomp as if he had been actually entertaining him.

CHAPTER XXII.—GARDEN CROPS.

1057. These may be divided into—(1) edible roots, (2) gourds, (3) miscellaneous.

EDIBLE ROOTS.

- (1) *Potatoes (solanum tuberosum or esculentum)*.—बाबू *ahu*, and in East Tirhut also बाबू *aru*. Also north of the Ganges बाबू *ahua* and बाबू *alus*. North of the Ganges लकड़ा *lalka* or दखिनी *dackhini* is a red kind, and मलदाहिया *maldahiya* or नपाही *napali* a white one. A red variety of the last name but one is called मलदाहिया कनकपुरिया *maldahiya kanakpuriya*. Seed potatoes brought from the hills are बीया के बाबू *biya ke ahu*, and each eye is आँखि *ankhi* or आँक *ankh*. The produce of these kept for next year is called पहिला मँटी के बीया *pahila mānti ke biya*, and the produce again of this kept for seed for the third year is दोसर मँटी के बीया *dosra mānti ke biya*.
1058. (2) *Yams (dioscorea sativa)*.—These are लतार *latār* generally north of the Ganges, and also रतार *ratār* to the west. To the north-west yet another name is अतार *atār*, and to the south-west कठार *kathār*. In Patna and Gaya it is रताबू *ratālu*. In Tirhut it is also called फर *phar*, and to the east also खम्हरा *khamharua*.
1059. (3) *Sweet potato (batatas edulis)*.—This is सकरकन्द *sakar-kand* generally. North of the Ganges it is also called लकड़ा *lalka* बाबू *lamka ahu*, and in South-East Tirhut बाबू *alhua*. In East Bihar it is बाबू *ahua*. North of the Ganges there are two varieties :—(a) A red one, called देसी *desi*, and also in South Tirhut लकड़ा *lalka*; (b) a white one, called बिलायती *bilāēti*, and also कर्मिया *karmiya*, and in South Tirhut also उजरका *ujarka*. A large white variety, weighing from one to twenty *sers*, is called in North-East Tirhut तेकुना *tekuna*.
1060. (4) A kind of yam (*dioscorea fasciculata*).—दुधनी *suthni*.
1061. (5) *Arum colocasia*.—This is अरुनी *arui* generally. Also अरबी *arabbi* in North-East Tirhut, पेकचा *pekcha* in South-East Tirhut, पेकची *pekchi* in Shahabad, पेपची *pepchi* in Gaya and Shahabad, and in South Bhagalpur

बलनी *alli*. Another variety (*colocasia antiquorum*) is कच्चा *kachchu*. A larger variety is अरुआ *arua* or कन्दा *kandā*.

1062. (6) राम केशोर *rām kesaur* (North Tirhut), or मिसिरी कन *misiri kan* (East Tirhut), a large edible root sometimes weighing eight or nine *sers*. Considered a very cooling food.
1063. (7) आदीचक *ādichak*, the Jerusalem artichoke (*helianthus tuberosus*).

GOURDS.

1064. (1) *The water-melon (cucurbit citrullus or citrullus vulgaris)*.—These are तरबूज *tarbūj* or तरबूजा *tarbūja* or in North-East Tirhut तारबूज *tārbhūj*. In Champaran they are also called पनीचौआ *panihaua*, and in South-West Shahabad हिनुआना *hinuāna*.
1065. (2) *The melon (cucumis utilatissimus or cucumis melo)*.—खरबूजा *kharbūja*. Also लालमी *lālmi* in West Tirhut and Patna and the west, and फूंट *phūnt* (which is properly the *cucumis momordica*) to the south-east.
1066. (3) *Cucumis momordica*.—This is फूंट *phūnt* when it is ripe after bursting spontaneously. The young fruit used for cooking is दास *dām* and (South-West Shahabad) दभको *dabhko*.
1067. (4) *The bitter gourd (momordica charantia)*.—करैया *karaila*, also करैली *karaili* in Shahabad and South Bhagalpur and करैल *karail* in North-East Tirhut.
1068. (5) *The bottle-gourd (lagenaria vulgaris or cucurbita lagenaria)*.—This is कदुआ *kadua* generally, or कद्दु *kaddu* in South Bhagalpur. Another name in Gaya, South Munger, and the west generally is लौआ *lauka*, with a variant लौआ *laua* in Patna. In East Tirhut it is also called सजिवन *sajivan*.
1069. (6) *Lagenaria acutangulus or cucumis acutangulus*.—This is तरोर *tarōr* generally. Other varieties are सतपुतिया *satputiya*, जिङ्गा *jhinga*, जिङ्गुनी *jhinguni*, or जिङ्गुली *jhinguli*, and नेमुआ *nemuān*, घिउरा *ghiura*, or घेवुआ *ghewra*.
1070. (7) *Cucumber (cucumis sativus)*.—खीरा *khira*. A variety is बालम खीरा *bālam khira* in Shahabad. A large variety of

cucumber is called ककड़ी *kakri* or कंकरि *kānkari* (*cucumis utilatissimus*). Natives much appreciate this vegetable, as in the proverb निकौरिया गेलां च घाट, कंकरि देखि हिवा घाट *nikauriya gelāh hāt, kānkari dekhi hiya phāt*,—the man without money went to market, and his heart burst when he saw the cucumber. The great size of the plant is well illustrated by the proverb एक हाथक कंकरि, नौ हाथक बीया *ek hāthak kānkari, nau hāthak biya*,—a cucumber only one cubit long has an offspring nine cubits long. (Cf. the parable of the grain of mustard-seed.)

1071. (8) The sweet pumplin (*cucurbita pepo*).—This is कौंभड़ा *koñhṛa*; also in North Tirhut कोम्भड़ा *komhṛa*, and in East Tirhut कदोमा *kadīma*. Another variety, much used for making sweetmeats, is भतुआ *bhatua* to the west; also भूआ *bhūa* or भूरा *bhūra* in Gaya, सिस्कोंभड़ा *siskoñhṛa* in Champāran, सिज्कोंभड़ा *sijkoñhṛa* in Tirhut, सुरज्कोंभड़ा *surujkoñhṛa* in South-East Tirhut, and कुम्हार *kumhar* to the east.

1072. (9) चिचिरा *chichira* or चिचुरा *chichura* (north of the Ganges), the snake-gourd (*trichosanthes anguina*).—In East Tirhut it is कैता *kaita*, and in Sāran कैत *kait*.

MISCELLANEOUS VEGETABLES (IN ALPHABETICAL ORDER).

1073. The writer regrets that he has not been able to identify the botanical names of more than a few of the under-mentioned plants. In some cases the identification given is doubtful. He has to thank Dr. Shaw, Civil Surgeon of Darbhanga, for much assistance rendered in correcting the botanical portion of this division.

अजमोदा *ajmoda* or (Tirhut) बनज्जेवारन *banjewāin*, parsley (*petroselinum sativum* or ? *apium involucreatum*).—Cf. पितरसेली *pitarseli*.

अजवारन *ajwāin*,—see जवारन *jawāin*.

अदरक *adrakh* or अदरक *adrak*, ginger (*zingiber officinale*), also आदी *ādi* generally, आद *ād* in South-East Tirhut.

असफगोल *asaphgol*,—see सफगोल *saphgol*.

आद *ād*, आदी *ādi*,—see अदरक *adrakh*.

इमिरन्ती *imirti*, or in Gaya रमन्चरन्ता *ramcharna*, an acid curry-vegetable, the fruit of *spondia mangifera* (?).

कच *kath*,—see खैर *khair*.

कमल पत्र *kamal patr*,—see पिदाज *piyāj*.

करमन्कला *karamkalla* or बन्धा कोबी *bandha kobi*, cabbage (*brassica oleracea*).

कलन्ती साग *kalmi sāg*, the tops of *convolvulus repens*, much used as a spinach.

कवाह *kawāchh*,—see केवाँह *kewānchh*.

कासन्ती *kāsni*, endive (*cichorium endivia*).

काह *kāhu* (Patna and Gaya), a kind of lettuce (*lactuca sativa*).

कुन्नी *kunri*, a creeping-plant, of which the fruit is used for curries.

केवाँह *kewānchh* or कवाह *kawāchh*, a plant which produces a pod like a bean (*dolichos pruriens*). In Gaya it is रूप बीज *bhūp sem*.

कैता *kaita*,—see चिचिरा *chichira*.

कोचन्ता के साग *kochla ke sāg*, a kind of spinach.

कोबी *kobi*, the cabbage (*brassica oleracea*).

खुरन्फा *khurpha* or गोलावा *golāwa* (Sāran, Patna, and Gaya), purslane (*portulaca sativa*).

खुसबरी *khusbari*,—see मकोब *makoe*.

खेकन्वा *khekhsa*,—see चढेह *chathail*.

खैर *khair* or कच *kath*, catechu (*acacia catechu*).

गदीना *gādina*, a kind of pot-herb with a taste of garlic.

गजन्ना or गजन्दा *gajra* or (in South-West Shahabad) गाजर *gājar*, the carrot (*daucus carota*).

गाजर *gājar*,—see गजन्ना *gajra*.

गुलन्फा *gulpha*, a kind of spinach.

गेन्हीरी *genhri* or (in East Tirhut) गेन्हीरी *genhāri*, a pot-herb (? *amaranthus frumentaceus*).

गलन्धन्ता *gelhanta*, गोलन्धन्ता *golbhanta*,—see बैंगन *baingan*.

गोलावा *golāwa*,—see खुरन्फा *khurpha*.

गोल मिरिच *gol mirich* or गुलमिरिच *gulmirich*,—see मिरिच *mirich*.

घेंच *ghench* (North-East Tirhut), an aquatic tuber whose white stalk is eaten by the poor (? *aponogeton monostachyon*).

चटैल *chathail* or चटैल *chatail*, a much-appreciated curry-vegetable, a creeping-plant. In Gaya it is called खेकसा *khekhsa*.

चमसुर *chansur*, a kind of cress (*lepidum sativum*).

पितरसेली *chitarseli*,—see पितरसेली *pitarseli*.

चेंगवा *chengua*,—see बैंगन *baingan*.

जवारन *javāin* (west, Patna, and South Bhagalpur), जवावरन *ajwāin* (Gaya and South Munger), जेवारन *jewāin* (north of the Ganges), a plant something like aniseed (*ligusticum ajowan* and *ptychotis ajowan*), खोरासांनी जवारन *khorāsāni javāin* is *hyosciamus niger*. This plant is not the true aniseed (*anisi*).

जीरा *jira* or (South-East Tirhut) जीर *jir*, cummin (*cuminum cyminum*).

जेवारन *jewāin*,—see जवारन *javāin*

डहिवा *tharhiya*,—see मारसा *mārsa*.

डिडिवा निरन्वार *diriya mirchāi*, डेरिवा निरन्वार *dheñriya mirchāi*,—see मिरिच *mirich*.

तरन्कारी *tarkāri*,—see तीयन *tiyan*.

तरन्कोंका *tarkonka* (Patna), the bud of the red lotus, used for medicine.

तीयन *tiyan*, तरन्कारी *tarkāri*, or पतौरा *pataura*, the general term for vegetables.

धनिर्चा *dhaniyān*, coriander (*coriandrum sativum*).

जेवार *newār*,—see मूली *mūli*.

पतौरा *pataura*,—see तीयन *tiyan*.

परन्वर *parwar*, पल्लवक *palwal*, परोर *paror*, परौरा *parora*, or (in South Bhagalpur) परोल *parol* (*trichosanthes dioica*), (Roxb.)

पल्लंकी *palānki*,—see पालक *pālak*.

पालक *pālak*, पाल्लंकी *pālki* or (East Tirhut and Champaran)

पल्लंकी *palānki*, spinach (*spinacea oleracea*).

पितरसेली *pitarseli* or (Tirhut) चितरसेली *chitarseli*, parsley (*petroselinum sativum* or ? *apium involucreatum*).—Cf. जममोदा *ajmoda*.

पिवाज *piyāj* or (South Bhagalpur) पेयाज *peyāj*, and north-west कमल पतर *kamal patr*, the onion (*allium cepa*).

पुदेना *pudena*,—see पोदीना *podina*.

पोदीना *podina*, पोदेना *podena*, or पुदेना *pudena*, also (Tirhut) छदेना *phudena*, mint (*mentha sativa* or *viridis*).

छदेना *phudena*,—see पोदीना *podina*.

छलन्वोनी *phulkobi*, the cauliflower (*brassica oleracea*).

बकन्हा *bakla*, बकुली *bakuli*, बँग्ला *bangla*,—see बोकन्हा *bokla*.

बजन्वोवारन *banjewāin*,—see बजन्वोदा *ajmoda*.

बजन्वुटन्का *banbhutka*,—see मकोष *makoe*.

बिरन्वार *birwāi* (Gaya), vegetable seedlings.

बिलाग्रती पट्टा *bilāēti patua*, roselle (*hibiscus sabdariffa*).

बिलाग्रती बैंगन *bilāēti baingan*, the tomato (*solanum lycopersicum*).

बैंगन *baingan*, भन्हा *bhanta* (usually confined to the round variety) or गोल्हन्हा *golbhanta*, and in South Munger also गेल्हन्हा *gelhanta* and चँगवा बैंगन *chengwa baingan*. In East Tirhut it is optionally भँडा *bhānta*; the egg-plant (*solanum melongena*). Compare the proverb काहू के भन्हा बैरी काहू के भन्हा पन्थ *kāhu ke bhanta bairi, kāhu ke bhanta panth*,—to some the egg-plant is an enemy, to others it is prescribed as a regimen; *i.e.*, what is one man's meat is another's poison.

बोकन्हा *bokla* or बँगन्हा *bangla* (north-west), बकन्हा *bakla* (Champan), बकुली *bakuli* (South-West Tirhut), बोकन्हा बीन *bokla bin* (South-East Tirhut) (?), a kind of bean (? *faba major*).

भटन्कुचाँ *bhatkūān*, भटन्कोँचा *bhatkoñā*,—see मकोष *makoe*.

भन्हा *bhanta*,—see बैंगन *baingan*.

भिन्डी *bhindi* or राम तरोर *rām taroi*, also to the east राम परोर *rām paror*, a long kind of fruit used for cooking (*hibiscus esculentus* or *abelmoschus esculentus*).

भुटन्का *bhutka*,—see मकोष *makoe*.

भूप सेम *bhūp sem*,—see केवाँच *kewānchh*.

मकोष *makoe* (west and Tirhut), छसन्बरी *khusbari* (gooseberry), or (purple variety) भटन्कोँचा *bhatkoñā* or भटन्कुचाँ *bhat kūān*, the cape gooseberry, or *tiparee* (*physalis Peruviana*). The red variety is also भुटन्का *bhutka* or बजन्वुटन्का *ban bhutka* in South-East Tirhut.

मरिचा *maricha*,—see मिरिच *mirich*.

मंरन्धा *mārsa* or डहिवा *tharhiya* (weat), *amaranthus mangostanus*.

मिरन्धा *mircha*, मिरन्धार *mirchāi*,—see मिरिच *mirich*.

मिरिच *mirich* or (West Tirhut, Shahabad, and Gaya) मरिचा *maricha* and मिरन्धार *mirchāi*, (Patna) मिरन्धा *mircha*, (South Munger) दिहिवा मिरन्धार *diriya mirchāi*, (Gaya) डैरिवा मिरन्धार *dheñriya mirchāi*, long pepper, &c. (*capsicum fastigiatum*, &c.) गोळ मिरिच *gol mirich* or गुळमिरिच *gul mirich* is black pepper (*piper nigrum*). Bird's eye pepper (*capsicum baccatum*) is लोंगिवा मरिचा *longiya maricha* or जेवा मिरन्धा *jaiya mircha*.

मुन्गा *munga*,—see सैयन *saiyan*.

मुररै *murāi*, मुरार *murāi*, मुळी *mulli*, मूर *mūr*, मूरो *mūro*,—see मूळी *mūli*.

मूळी *mūli*, मुळी *mulli*, or मुररै *murāi* or (East Tirhut optionally) मूर *mūr*, (South Munger) मुरार *murāi*, (South Bhagalpur) मूरो *mūro*, the radish (*raphanus sativus*). In Shahabad there are two kinds—(1) नेवार *newār*, which is large, and (2) लुतिवा *lutiya* or देसिला *desila*, which is small.

मेथी *methi* or मेंथी *menthi*, fenugreek (*trigonella fenum Græcum*).

रमन्चरणा *ramcharna*,—see इमिरिती *imirti*.

रखन *rasūn*, रसुन *rassun*,—see लहसुन *lahsun*.

रहरिवा सेम *rahariya sem* or राम रहर *rām rahar*, a kind of bean, not a climbing-plant, but a shrub.

राम तरौर *rām taroi*, राम परोर *rām paror*,—see भिन्डी *bhindi*.

लहसुन *lahsun*, or to the east रखन *rasūn* or रसुन *rassun*, garlic (*allium sativum*). A clove of garlic is पोटी *poti* or पोड *pot*.

लुतिवा *lutiya*,—see मूळी *mūli*.

लोंगिवा मिरिच *longiya mirich*,—see मिरिच *mirich*.

सधनोळ *saphgol*, or in South-West Shahabad लसफनोळ *asaphgol* (*phantago isabghola*).

सलजम *salgam* and also (south of the Ganges) सलजम *saljam*, the turnip (*brassica rapa*).

सलजम *sahjan*, &c.,—see सैयन *saiyan*.

सिंघाड़ा *singhāra*, the water-caltrop (*trapa bispinosa* or *natans*).

सीम *sim*,—see सिम *sem*.

सिम *sem* (west), सीम *sim* (east), a bean (*phaseolus magnus*). A variety is सिमा *sema*.

सैयन *saiyan*, or (Tirhut) सोहिजन *sohijan* or सोहजन *sohjan* or सहजन *sahjan*, or (Shahabad) सहिजन *sahhijan* or (Patna) सहजना *sahjana*, the horse-radish tree (*hyperanthera moringa*). Its fruit is called मुन्गा *munga*, and is used as a vegetable, and its root (which tastes like horse-radish) is used as a condiment.

सौंफ *saumph*, ? a kind of aniseed (*peucedanum graveolens* or *anethum sowa*).

हरदी *hardi*, or in Shahabad optionally सहदी *haldi*, turmeric (*curcuma longa*).

सहदी *haldi*,—see हरदी *hardi*.

SUBDIVISION II.

INSECTS AND CAUSES OF INJURY TO CROPS.

CHAPTER I.—DESTRUCTIVE INSECTS AND DISEASES.

1074. Among these may be noted the following, which are arranged in alphabetical order:—

अंगरा *angra* (north-west), झरका *jharka* (Saran and Tirhut), blight in cereals caused by the sharp west wind; also (Champaran) a blight in opium. See मुरका *murka*.

अरैया *araiya*,—see पोचारी *podri*.

उकठा *uktha* (south), a sort of mildew which dries up the grain in wheat.

उकड़ा *ukrha*, उकरा *ukhra*, उकसा *uksa*,—see उकठा *ukthha*.

उकथा *ukthha* or उकड़ा *ukrha* (north generally), उकरा *ukhra* (Tirhut), उकसा *uksa* (north-west), withering of crops from excessive drought.

औरङ्ग *aurang* (Champaran),—see गपनू *gaptu*; also (north-west) or (in Tirhut) बभनी *babhni*, a white spot appearing in the

leaf of millets, causing them to wither up.

कचोहा *kachoha* (South Bhagalpur), a disease in tobacco.

कजरा *kajra*,—see कजरी *kajri*.

कजरी *kajri* (generally), कजरा *kajra* (West Tirhut, Patna, and Gaya), कजला *kajla* (North-West Tirhut), कजरी *majri* (East Tirhut), a green grub which eats the young plants of rice, wheat, and barley when they are about six inches high.

कजला *kajla*,—see कजरी *kajri*.

कटहर *katui*, an aquatic beetle which infests rice.

कटेवा *kataiya* (South-West Shahabad), कटोई *katoï*, कटोईवा *katoïya* (elsewhere south of the Ganges), a blight which attacks rice and turns the ears an orange colour and destroys them.

कटोईवा *katoïya*, कटोई *katoï*,—see कटेवा *kataiya*.

कनरी *katri* (South-West Shahabad), a disease of the rice-plant.

कनाठा *kanātha*, कन्ही *kanhi*,—see चीरी *chhīri*.

कपना *kapta* (Champanan), an insect which attacks young rice.

कसुवा *kamua*,—see कसा *kamma*.

कसा *kamma* or कसुवा *kamua* (Patna), a smooth kind of caterpillar.

किरीना *kirauna*,—see गाँधी *gāndhi*.

कीरी *kiri* or (South Bhagalpur) कीरो *kiro*, a maggot.

कुङ्करी *kukurhi* (Sāran and Tirhut), an insect which attacks cotton.

कुङ्करी *kukuhī* (north-west), an insect which injures the cold-weather crops.

कुसुवटना *kuswatna* (north-west), कुसियाना *kusiyāna* (Tirhut), a blight in transplanted rice.

कुसियाना *kusiyāna*,—see कुसुवटना *kuswatna*.

कैनुआँ *keñuān*,—see करवा *larka*.

कोईवा *koiya*, a tiny black insect which does great damage in granaries.

कोईली *koili*, कोईया *korhiya*, कैलिया *kailiya*, blights of various kinds in rice.

कोईया *korhiya*, कैलिया *kailiya*,—see कोईली *koili*.

कंखरी *khankhri*, a blight in cereals on account of which no grain is produced in the ear.

खपग्रोरवा *khaproïya* (Champaran), गङ्गरा *garra* (Gaya, Saran, and Tirhut), a small white insect which attacks rice.

खरुका *kharuka*,—see जाळा *jāla*.

खैरा *khaira* (west), खैरी *khairi* (North-East Tirhut), a blight which attacks rice and turns the ears an orange colour and destroys them.

गङ्गरा *garra*,—see खपग्रोरवा *khaproïya*.

गङ्गार *garār* (north), a grub which attacks the roots of sugar-cane.

गङ्गो *gadhi* (north) or (Saran and East Tirhut) गङ्गिया *gadahiya*, an insect very destructive to growing pulses.

गङ्गो *gandhi* (Patna and Saran), a small green fly, which attacks rice.

गङ्गी *gandhi*,—see गङ्गी *gandhi*.

गपन्तू *gaptu* or गपन्तुवा *gaptua* (Patna and north), गपन्तू *gabhtu*, ठोंठियारी *thonthiyari* (Shahabad), गपन्तू *gapsu* (Saran), and चौरङ्ग *aurang* (Champaran), a disease affecting millets, sugar-cane, and Indian corn, in which the tops wither.

गपन्तू *gabhtu*,—see गपन्तू *gaptu*.

गादुर *gādur* (South-West Shahabad), an insect which attacks pease and gram.

गङ्गी *gandhi* or गङ्गी *gandhi*, also to the west गङ्गिया *gandhwa*. Other names are मञ्ची *mānchhi* (north generally), किरौना *kirauna* (South-West Shahabad), and भेमरा *bhemra* (South Munger), the flying-bug,—an evil-smelling insect, which attacks principally the millets before the flowers are formed.

गेरुवा *gerua* (west), the grub which attacks the roots of sugar-cane.

गेरु *gerui* (north and south-west), a disease of the cereal crops, in which the plant dries up and assumes a reddish colour while the ear is black. It is caused by excess of winter rains and east wind.

गोबरा *gobraura* (West Tirhut and west), blight in betel.

- गोभी *gobhi*, a disease produced by prevalence of severe winds, and consisting in the plant giving out little shoots, which weaken it.
- गौची *gaunchhi* (West Tirhut, Patna, and Gaya), an aquatic beetle which destroys rice by floating from one plant to another in a boat made of a leaf.
- घँघरी *ghanghri* (Shahabad),—see घोंघड़ी *ghonghri*.
- घुन *ghūn*, a weevil destructive to wood and grain.
- घोंघड़ी *ghonghri* or (Shahabad) घँघरी *ghanghri*, a worm in the ear of millets and gram.
- चमरा *chatra*,—see चुपार *muār*.
- चपटना *chapatwa* (South-West Shahabad), a small green fly which attacks rice.
- चपटा *chhapta* (north-west), चपकटा *pachkatta* or (Tirhut) चकटा *patkatta*, a green caterpillar which eats up the rice-plant.
- चीरा *chhira*,—see चीरी *chhiri*.
- चीरी *chhiri* (south and west), चेंड़ी *chhenri* north-west and Tirhut), also चीरा *chhira* in Champaran. Other names are कन्ही *kanhi* (South Munger) and कनाठा *kanātha* (South Bhagalpur), the palmer (?) worm, which attacks pulses, cotton, and tobacco.
- चेंड़ी *chhenri*,—see चीरी *chhiri*.
- जाळा *jāla* (Tirhut, Patna, and east), पकखन *pakkhan* (West Tirhut and Gaya), खरुका *kharuka* (South-West Shahabad), मुरका *murka* (west and West Tirhut), a blight in opium.
- जरका *jharka*,—see अंगरा *angra*.
- जिल्ली *jhilli* (north-west), फुलभङ्गा *phulbhanga* (Tirhut), an insect which eats the stalks of pulses and makes the leaves crumple up.
- टाड़ा *tāra* or टाँड़ा *tānra* (west), a small green insect which ravages wheat and eats the roots of sugar-cane.
- टाड़ा *tāra* (north-west), टाँड़ी *tānri* (North-West Tirhut), a grub which eats the young plants of wheat and barley when they are about six inches high.
- टीर्री *tiri* or (South-West Shahabad) टिररी *tirri*, and फरिंगा *pharinga* (Tirhut and east), the locust.

हुनकी *tunki* (north), a disease which attacks rice.

डोंडिचारी *thonthiyari*,—see गपगु *gaptu*.

तितिली *titili*, a butterfly.

तेलचट *telchat* (Patna and east), पटोर *patoī* (West Tirhut, Gaya, and South Munger), a disease of the castor-oil plant.

दखिनहा *dakhinba*, (north and south-west), also दखिनाहा *dakhinaha* (Gaya and south-west); also नीमा *nima* (North Tirhut), सिरोरा *sirora* (Patna), and पीरो *piro* (South Bhagalpur), a disease of rice, millets, and sugar-cane caused by a noxious wind from the south. A white spot appears on the leaf of millets, and they wither. In sugar-cane the tops wither.

दहिवा *dahiya* (north), a disease in चीना *china* (*Panicum frumentosum*).

दिअँका *dianka*, दिउँका *diunka*, दिअँका *diyānra*, दिवार *diyār*, दिवार *diwār*,—see दीअँ *diyān*.

दीअँ *diyān* or दिअँका *diyānra* (Patna, Gaya, and south-east), दिउँका *diunka* (South-West Shahabad), दिअँका *dianka* or दिअका *diaka* (west generally), दिवार *diyār* (Champāran and Tirhut), and दिवार *diwār* (East Tirhut), the white ant.

नीमा *nima*,—see दखिनहा *dakhinba*.

नेहा *nerha*,—see लँहा *lenhra*.

पकखन *pakkhan*,—see जाहा *jāla*.

पककी *pakkhi* or पखिया *pakhiya*, a small insect which attacks the *singhāra* plant or water-caltrop (*trapa natans* or *bispinosa*).

पककहा *pachkatta*, पतकहा *patkatta*,—see चपडा *chhapta*.

पटाही *patārhi*,—see पेटाही *petārhi*.

पटोर *patoī*,—see तेलचट *telchat*.

पिटोर *pitoi* (Patna and South Munger), a small green insect, which ravages wheat and eats the roots of sugar-cane. = टाँरा *tānra*, *q. v.*

पिछू *pillu* or पिछुवा *pihua*, a small white maggot, which attacks cotton, safflower, and grain, whether growing or stored.

- पिडिका *pihika*,—see सुकन्दा *sukhra*.
- पीरो *piro*,—see दक्षिणघा *dakhinha*.
- पेटाही *petārhi* or पटाही *patārhi* (Tirhut), an insect which attacks stored rice only.
- पेटारणी *petārhi* (Shahabad), a red-coloured insect which attacks cotton, gram, and the castor-oil plant.
- पेया *paiya*, a worm in the ear of grain.
- पोषारी *poāri* (east) or चरैया *araiya* (South Munger), a disease of the rice-plant.
- पौंही *paunchhi* (Patna and South Munger), a branch springing from the root of sugar-cane and injuring it.
- फठ्ठा *phatha* (South Bhagalpur), फहा *phatta* (South Munger), a disease of the rice-plant.
- फहा *phatta*,—see फठ्ठा *phatha*.
- फतिङ्गी *phatingi*, a kind of grasshopper which eats the leaves of sugar-cane.
- फन्गी *phangi* (west), a kind of grasshopper which appears in years of drought and attacks roots of wheat and gram.
- फनिगा *phaniga*,—see सुरन्का *surka*.
- फरिङ्गा *pharinga*,—see डीही *tiri*.
- फाटी *phāti*, a blight in the ear of rice.
- फाँड़ा *phānra* (Tirhut) or फाँड़ी *phānri* (Tirhut), a weevil destructive of wood and grain.
- फुल्लङ्गा *phulbhanga*,—see जिहो *jhilli*.
- बकुला *bakula*,—see बकी *bakki*.
- बकुली *bakuli* (south-west), a green caterpillar destructive to rice.
Of. काजरी *kajri*.
- बकेया *bakeya*,—see बकी *bakki*.
- बकी *bakki*, also बकेया *bakeya* or बकुला *bakula* (also in West Tirhut) in Shahabad, and बुडिया *burhiya* or बड़नी *barhi* in South Bhagalpur, a small kind of caterpillar which attacks rice. A larger kind is बाँका *bānka*.
- बड़नी *barhi*,—see बकी *bakki*.
- बभनी *babhni* (Tirhut), a blight affecting rice, sugar-cane, millets, and opium. See also औरङ्ग *aurang* and सुरन्का *murka*.

बहुषा *balua*, बहुरी *balui*,—see बालू *bālu*.

बाँका *bānka*,—see बक्की *bakki*.

बाँकी *bānki* (Gaya), a disease which attacks the leaves of trees (especially the pepper-tree), and causes them to curl up and wither.

बाला *bāla*,—see बालू *bālu*.

बालू *bālu* or बहुषा *balua* (Patna, Gaya, and south-east), बहुरी *balui* (Shahabad), बाला *bāla* (South-West Shahabad), an insect which eats the stalks of pulses and makes the leaves crumple up.

बीजल *bijhal* (Gaya and South Munger), weevil-eaten.

बुद्धिया *burhiya*,—see बक्की *bakki*.

भङ्क *bhankh*,—see भाँक *bhānkh*.

भरङ्का *bharka* (West Tirhut and south-east), an insect injurious to rice, caused by prevalence of south winds and excess of rain.

भँवर्रा *bhāñwra*,—see भँव्रा *bhenra*.

भरङ्की *bharki* (South Bhagalpur), a disease of the rice-plant.

भाँक *bhānkh* (north) and also भाँकी *bhānki* (north), भङ्क *bhankh* (east), a blight which attacks the millet चाँवाँ *sañwān* (*panicum frumentaceum*).

भुरला *bhuila*, भुरली *bhuili*, भुरुरी *bhurri*, भुरली *bhurli*, भुरिका *bhurila*, भुरिली *bhurili*,—see भूषा *bhūa*.

भूषा *bhūa* (Tirhut, Patna, Gaya, and east), भुरला *bhuila* or भुरली *bhuili* (West Tirhut and north-west), also भुरली *bhurli* (Sāran), भुरिका *bhurila*, भुरिली *bhurili*, or भुरुरी *bhurri* (south-west), a hairy worm which eats the leaves of the castor-oil plant and pulses, and is fatal to cattle when eaten.

भँव्रा *bhenra* or भँवुर्रा *bhenrwa* (Patna and east), भँवर्रा *bhāñwra* (West Tirhut and Shahabad), an insect which attacks millets and stored grain in dry weather.

भेमर्रा *bhemra*,—see गाँधी *gāndhi*.

मङ्गरा *mangra* (South-West Shahabad), an insect which attacks the sugar-cane in the root.

मजरी *majri*,—see कजरी *kajri*.

मरहिना *marhinna*, मरी *mari*,—see मुबार *muḍr*.

माँची *mānchhi*,—see गाँधी *gāndhi*.

मारा *māra* (North-East Tirhut), a disease in rice which withers the plants.

मुबार *muḍr* (west), चमरा *chatra* (Patna and Gaya), मरहिना *marhinna* (Tirhut and East), मरी *mari* (West Tirhut and South Bhagalpur), a disease in which the whole plant is burnt up.

मुरका *murka* (north), also अंगरा *angra* (Champaran), and बभनी *babhni* (Tirhut), a blight in opium. See जादा *jāla*.

मुरिया *muriya*,—see सुखड़ा *sukhra*.

लक्ष्मिनिवा *laxhmīniya* (East Tirhut), a small, thin, red-coloured beetle found in granaries. It does no harm, and is revered by grain-merchants.

लरका *larika* or (Gaya) लुरका *lurka*, a worm which attacks gram and pease. North of the Ganges it also burrows into the ribs of the leaf of the tobacco-plant, and is then called केवर्वा *keḅvā* in Tirhut.

लाही *lahi*, plant-lice.

लेरहा *lenrha* (west and West Tirhut), नेरहा *nerha* (Tirhut), a disease in wheat or barley in which the ears turn black.

सरका *sarka*, a worm in the root of rice.

सिरका *siruka*,—see सुरका *surka*.

सिरोरा *sirora*,—see दक्षिणहा *dakhinḅa*.

सुखठा *sukḅṅṅa*,—see सुखड़ा *sukhra*.

सुखड़ा *sukhra* (West Tirhut and south generally), सुखठा *sukḅṅṅa* (West Tirhut and west), पिहिका *pihika* (rest of Shahabad), मुरिया *muriya* (South Bhagalpur), a blight in sugar-cane.

सुंदरी *sundri* (east), an insect which eats the leaves of the castor-oil plant.

सुन्दा *sunda*,—see सून्दा *sūnra*.

सुरका *surka* (East Tirhut and Shahabad), सिरका *siruka* (Saran and Patna), फणिना *phaniga* (Tirhut and South-West Shahabad), an insect which eats the leaves of sugar-cane and destroys gram, pease, and cereals.

सूँडा *sūnra* or सूँडी *sūnri* (Tirhut and south generally), सूँह *sūnrh* or सूँहा *sūnrha* (Gaya), सुन्दा *sunda* (West Tirhut and south-east), a kind of weevil destructive to wood and stored grain. Cf. कीरी *kiri*.

सूँह *sūnrh*,—see सूँडा *sūnra*.

बड्डा *hadda* a white stem growing out of the root of the tobacco-plant, and throwing it far out of the soil.

बडिया *hathiya* (North-East Tirhut and Gaya) and बडिया सुन्दा *hathiya sunda* (south-east), a small white insect which damages rice.

बरन्दा *harda* (north and east), a sort of mildew which dries up the grain in cereal crops. The plant turns yellow, and the ear black.

CHAPTER II.—NOXIOUS WEEDS.

1075. These are as follows :—

अँकटा *ankta*,—see अँकरा *ankra*.

अँकरा *ankra* or अँकरी *ankri* (West Tirhut and Shahabad), अँकटा *ankta* (Tirhut and elsewhere south) (*vicia sativa*), it appears in wheat.

अगिया *agiya* (north and east), a weed which burns the rice-plant (from आग *ag*, fire).

उखड़ा *ukhra*,—see बड्डा *hadda*.

उरकुस्सी *urkussi*,—see बिहौलिया *bichhautiya*.

ककना *kakna* (Patna, Gaya, and south-east), बनसारी *bansari* (Shahabad and East Tirhut), a weed which chokes crops.

कठरँगनी *kathrengni*,—see रँगनी *rengni*.

कनवाँ *kanwān*, कना *kanna*,—see काना *kāna*.

कनचन *kansan*,—see काँसी *kānsi*.

काना *kāna* (Tirhut, Patna and east), कना *kanna* (north-east Tirhut), कनवाँ *kanwān* (Gaya), केना *kena* (West Tirhut and west), a weed which chokes rice (a species of *Coix*).

काँसी *kānsi* (West Tirhut, Patna, Gaya, and the south-east), कास *kās* (Shahabad and North Bihar), कनचन *kansan* (Sāran), (*saccharum spontaneum*), a most destructive grass.

केना *kena*,—see काना *kāna*.

कोरु खो *koil kho*,—see मोरगुह *gorkhul*

खरुका *kharuka*,—see खरगुवा *kharthāa*.

खरगुवा *kharthāa* (Patna and Gaya), बहूवा *bathua* (generally)
खरुका *kharuka* (North-East Tirhut and Shahabad), मोचही
mochatti (ditto), a weed in opium.

खरुका *khurka* or मछैवी *machhāi* (north), also रुदारी *rudri* (Saran),
a weed in opium. Cf. रुदारा *rudra*.

गदगदर *garhar*,—see गौदर *gānrar*.

गदरो *garhro*,—see गेदरुववा *gerharua*.

गदर *garār*,—see गौदर *gānrar*.

गौदर *gānrar* (West Tirhut and Patna), गदर *garār* (Tirhut and
east), जमार गदर *jamār garār* (South Munger), गदगदर
garhar (South-West Shahabad), a weed which injures
rice (various species of *Coix*).

गेदरुववा *gerharua* (north-west), गदरो *garhro* (North Tirhut),
a weed in cereal crops.

गोहला *gokhula*,—see मोरगुह *gorkhul*.

मोरगुह *gorkhul* (west), बाँसी *bānsi* (generally), गोहला *gokhula*
(West Tirhut, Patna, Gaya, and South Munger), कोरु खो
koil kho, a plant which injures rice (*tribulus terrestris*).

चपड़ा *chupra*,—see धुरपा *dhurpa*.

चिचोर *chichhor*, चिचोर *chichor*, चिचोरी *chichori*,—see लेंरई *lenrai*.

चौपडा *chaupatta*,—see पिपरा *pipra*.

जंगला *jangla*,—see जिहवा *jhirua*.

जमार गदर *jamār garār*,—see गौदर *gānrar*.

जम्हार *jamhār*, जाम्हार *jāmhar* (Patna and South Munger), जिम्हार
jinhār (South-West Shahabad), and दम्हरो *damharo* (South
Bhagalpur), a coarse hard grass, infesting poor soils
(varieties of *andropogon*.)

जाम्हार *jāmhar*,—see जम्हार *jamhār*.

जिनवाँ *jinwān*, a grass something like दूब *dūbh*, *q.v.*

जिम्हार *jinhār*,—see जम्हार *jamhār*.

जहर *jhār*, जहंगा *jhānga*, जार *jhār*,—see जारङ्ग *jhārang*.

कारङ्ग *jhārang* (north-west), कारंगा *jhānga* (Shahabad), कार *jhār* or कार *jhar* (Tirhut and east), a weed which injures rice.

जिबवा *jhirua* (Patna, Gaya, South Munger, and North Bihar).
जिरीवा *jhiraui* (South Munger), जिग्वा *jhircā* (South Bhagalpur), जंगला *jangla* (South-West Shahabad), जीरो *jhīro* (East Tirhut), a weed which chokes rice.

जीरो *jhīro*,—see जिबवा *jhirua*.

ठोकरा *thokra*,—see बिहीतिवा *bichhautiya*.

दमरो *damharo*,—see जम्हार *jamhār*.

दर *dar*, देवोरा *deyora*,—see मोंथा *montha*.

दामी *dābhi* (north) a coarse grass, injurious to crops (*xyris indica*).

तिलिही *titili*,—see पिपरा *pipra*.

दुबिया *dudhiya*,—see हड्डा *hadda*.

दूब *dūb* or दूब *dūb* (north and east), also दुब्धी *dubhi* (south), a grass which overspreads fallow fields (*cynodon dactylon*).

धुरपा *dhurpa* (Patna, Gaya, and South Munger), धुरप *dhurup* (South Bhagalpur), चपड़ा *chāpra* (Shahabad), a tough, coarse grass spreading over uncultivated lands, which are inundated yearly (*cynodon dactylon*). It is only removed by digging.

नकखिकनी *nakchhikni*,—see रेंगनी *rengni*.

पिपरा *pipra* (Saran, Patna, and east), पुपरा *pupra* (South Bhagalpur), चौपडा *chaupatta* (South-West Shahabad), तिलिही *titili* (generally), a weed in wheat.

पुपरा *pupra*,—see पिपरा *pipra*.

बड़गोडना *bargohuma* (south and east), a weed in wheat.

बहुवा *bathua*,—see खरथुवा *kharthūa*.

बनपियजुवा *banpiyajua*, बनपियाज *banpiyāj*, and बनरसना *banrasna*,—see रुआरा *ruāra*.

बनसारी *bansāri*,—see ककना *kakna*.

बसांही *basānhi*,—see बसांता *basāunta*.

बसांता *basāunta* (West Tirhut and north-west), बसांही *basānhi* (Tirhut), a weed which injures the spring crops (*acalypha indica* ?)

बाँसी *bānsi*,—see गोरखुल *gorakhu*.

बिहौलिया *bichhautiya* or बिहलिया *bichhutiya* is a parasitic plant which injures the poppy. It is also called भरभार *bharbhār* in South-West Shahabad, थोकरा *thokra* in the rest of that district and north of the Ganges, and उरकुसी *urkussi* in South-East Bihar.

भंगरा *bhangra* (West Tirhut, Patna, Gaya, and South Munger), भंगरैया *bhangriya* (Tirhut and east), भंगरिया *bhengariya* (North Bihar and Shahabad), भंगरिया *bhangariya* (Tirhut) (*cerbesina prostrata*), a small creeping-weed with a white flower which injures rice.

भंगरिया *bhangariya*,—see भंगरा *bhangra*.

भरभार *bharbhār*,—see बिहौलिया *bichhautiya*.

भंगरिया *bhengariya*,—see भंगरा *bhangra*.

मकरा *makra* (north and east), a rough coarse grass spreading over uncultivated lands which are inundated yearly. It is only removed by digging (*cynosurus*).

मखैती *machhaiti*,—see खरका *khurka*.

मडेर *mañer* (Patna, Gaya, and east), मडर *marar* (South Bhagalpur), मरेन *maren* (Shahabad), a weed which chokes rice.

मोचही *mochatti*,—see खरका *khurka*.

मोंथा *montha*, also दर *dar* and मौना *mauna* (also in West Tirhut) in the south-east, and डेयोरा *deyora* in South Munger. A coarse grass which grows in uncultivated land and injures the autumn crops (*cyperus rotundus*).

राड़ी *rāri* (north), a coarse hard grass infesting poor soils.

रुआरा *ruāra* (Patna), बनरसन *banrasna* (Gaya and South Munger), बनपियाज *banpiyaj* or बनपियजुआ *banpiyajua* (Tirhut and Shahabad), a weed which grows in opium. Cf. खरका *khurka*.

रुआरी *ruāri*,—see खरका *khurka*. Cf. रुआरा *ruāra*.

रँगनी *rengni*, the Mexican poppy (*argemone Mexicana*), a thistle-like plant, which overspreads fallow fields. It is also called नकखिकनी *nakchhikni* or (to the east) कठरँगनी *kathrengni*. It was introduced into India in a cargo

from Mexico within the last hundred years, and is now very common.

लेहर *leñras* (north-west), चिचोर *chichor* (north and Gaya), चिचोरी *chichori* (Tirhut), चिचहोर *chichhor* (east), चिचोरो *chichoro* (South Bhagalpur and Tirhut), a weed which chokes rice.

हड्डा *hadda* or उखड़ा *ukhra* (West Tirhut and south), or (West Tirhut and Gaya) दुधिया *dudhiya*, a small creeping-plant injurious to crops (*euphorbia hirta*). Cf. also § 1183 for other names.

CHAPTER III.—MISCELLANEOUS.

1076. A stunted crop is बैठल हासिल *baithal hāsīl* north of the Ganges. In Shahabad and West Tirhut it is सितुरियाप्रल *situriyāēl* or ततुरियाप्रल *taturiyāēl*, or in Sāran, सुतरियाप्रल *sutariyāēl*. In Gaya it is ठिंगुरियाप्रल *thinguriyāēl*, in Patna भेंटवांस *bhentwāns*, in West Tirhut and South Munger थुरियाप्रल *thuriyāēl*, and in South Bhagalpur बिरनिवाप्रल *birniyāēl*. A blighted ear is मराप्रल *marāēl* north of the Ganges. In Shahabad it is अबदा *abda* or दगदर *dagdār*, in Patna and Gaya कोइल *koīl*, and in the south-east मरा *mara*. पैया *paiya* in Gaya and the west, and भोर *bhor* to the north-east, is rice in which the ears have no seed. Blighted millets are called भक्कियाप्रल *bhakkhiyāēl* in the north-west, and भक्क चटुआ *bhakk chatua* in Tirhut. In Shahabad they are खुक्का *khukkha* or खोजड़ा *khojra*, in Gaya अलगल *algal*, and in Patna फुलहार *phulhar*.

1077. Crops withered from drought are to the west and in West Tirhut मुहार *muār*; in Gaya they are मोहार *modār*, and in Patna मुवाल *mual*. To the east and in Tirhut they are मरहेना *marhena* or मरहिना *marhinna*, and in South Bhagalpur also मरा *mara*. An irretrievably spoilt crop is बिगल हासिल *bigrāl hāsīl* north of the Ganges. In Shahabad it is बंक्ता *bānkta*, and in Patna चुचुहिया *chuchuhiya*. Scarcity of rain is सुहार *sukhār*.

1078. Failure of seed is बिजमार *bijmār* in Gaya and the west. In South Munger it is बीया मार *biya mār*. North of the Ganges it is also निबिज *nirbijj*, निबीज *nirbij*, or अबिज *abijj*. Other names are बंजौरा *banjhaura* (South-West Shahabad), बंजी *banjhi* (rest of Shahabad), बंजोरी *banjhauri* in Patna, and देहाप्रल *daihäēb* in South Bhagalpur. In North-East Tirhut there is also कौर जाप्रल *kaur jāēb*, and in East Tirhut भक्क जाप्रल *bhakkhar jāēb*.

1079. Crops trodden down by cattle are धंगठ (also spelt धङ्गाठ) *dhangāth* north of the Ganges, local variants being दंगठ *dangāth* in South-East Tirhut, धंगारु *dhangārel* in Sāran, and धंगेरु *dhanger* in West Tirhut and Champaran. In South-West Shahabad they are लहनाइल *lahnāil*, in Gaya and South Munger खुरखुन *khurkhān*, and in South Bhagalpur खिंची *khinchi*. In East Tirhut they are also called निघेस *nighes*.

1080. Crops laid by the wind are called गिरल *giral* or खसल *khasal*. A hot dry wind which burns up crops is to the west called जोला *jhola*, and such crops are known as जोलारु *jholāil* or जोंकरु *jhonkral*. To the east it is धाहा *dhārha* or धाही *dhārhi*. A frosty wind which frost-bites the crops is पाहा *pāla* or (to the east) पहा *palla*. The same words are used for frost-bite itself, and a frost-bitten crop is पलमारु *palmarua*. An inundation is दहार *dahār* or बाढ़ *bārh*, also बाढ़ि *bārhi* (North-East Tirhut), धाध *dhād* (Gaya), धाधन *āphat* (Patna), and बोहा *boha* or धार *khār* in the south-east. Morning fogs are कुहा *kūha*, of which optional local variants are कुहेस *kuhes* or कुहेसा *kuhesa* to the west and कुहसा *kuhassa* in South Bhagalpur. कुहेस *kuhes* is also current in North-East Tirhut, and in South-East Tirhut we find कुहेस *kumhes*. A fog in the day-time is धूध *dhūn* or धूध *dhāndh*. Hail-stones are पत्थल *patthal*, पत्थर *patthar*, पाथर *pāthar*, or बनौरी *banauri*, a local variant of the last being बंगौरी *bangauri* or बंगौरिया *bangauriya* in West Tirhut, Patna, and the east.

DIVISION VI.

AGRICULTURAL TIMES AND SEASONS.

1081. The* Bihār agriculturist follows the Hindu year in calculating his seasons. The year is divided into twelve lunar months (भाद्र *mās*, मास *mās*, महिना *mahina*, महिना *mahinna*, or महीना *mahina*) of 30 days each, and therefore consists of 360 days. Each month is further divided into a first or dark half [किरुन पक्ष (or पक्ष) *kisun pakh* (or *pachchh*)] (commencing with the first day of the wane of the moon), and a second or light half (सुकल पक्ष *sukl pakh*). Roughly speaking, a Hindu month commences at about the 15th of an English month; but as there are thus only 360 days in a year, they begin each year somewhat earlier in the solar year than the year before, till the calendar is brought nearly right every third year by the insertion of an intercalary month (मलमास *malmas*) of 30 days every third year.

1082. Besides the above, another important division of the year must be noticed,—that into lunar asterisms (नक्षत्र *nakhat*, नक्षत्र *nachhatr*, or निक्षत्र *nichhatr*). There are 27 of these in each year, and consequently $2\frac{1}{4}$ in each month. Each asterism is not of equal length. The longest is हथिया *hathiya*, which is 16 lunar days. The others range from about 13 lunar days in the dry months to 15 lunar days in the wet. Every agricultural operation commences in a certain asterism, and so it is necessary to know when they occur. The accompanying table shows roughly the relative positions of the English and Hindu months and of the lunar asterisms.

* Part of the following will be found in Carnegy's Kachahri Technicalities, s.v. *nakhat*.

| APPROXIMATE EUROPEAN MONTH. | Name. |
|-----------------------------|---|
| Part of September | श्रावण <i>Āsin</i> or कुषाव <i>Kuār</i> |
| October | कातिक <i>Kātik</i> |
| November | पुष्य <i>Aghan</i> |
| December | पूस <i>Pūs</i> |
| January | साध <i>Māgh</i> |
| February | फागुन <i>Phāgun</i> |
| March | चैत <i>Chait</i> |
| April | बैसाख <i>Baisākh</i> |
| May | जैठ <i>Jeth</i> |
| June | असाढ़ <i>Akhār</i> or असाढ़ <i>Asār</i> |
| July | श्रावण <i>Sāwan</i> or साधोन <i>Sāon</i> |
| August | भादों <i>Bhādōñ</i> |
| Part of September | |

Months.

| Dark half (किंशुन पक्ष <i>kisun pakh</i>) and light half (सुकल पक्ष <i>sukl pakh</i>). | Asterisms, of which there are two and a quarter to each Hindu month. |
|--|--|
| Dark | १ of उत्तरा फगुनी <i>Utra Phaguni</i> . |
| Light | हस्त <i>Hast</i> or हथिया <i>Hathiya</i> . |
| | चितरा <i>Chitra</i> . |
| Dark | साती <i>Swāti</i> or सिवाती <i>Siwāti</i> . |
| Light | बिसाखा <i>Bisākha</i> . |
| Dark | अनुराधा <i>Anurādha</i> . |
| Light | ज्येष्ठा <i>Jyēṣṭha</i> . |
| Dark | मूल <i>Mūl</i> . |
| Light | पूर्वाषाढा <i>Purba Khārḥ</i> . |
| Dark | उत्तराषाढा <i>Utra Khārḥ</i> . |
| Light | सावन <i>Sāwan</i> . |
| Dark | धनिष्ठा <i>Dhanishtha</i> . |
| Light | सतमीखा <i>Satbhikha</i> |
| | पूर्व भद्रपद <i>Pūrab Bhadrāpad</i> . |
| Dark | उत्तर भद्रपद <i>Uttar Bhadrāpad</i> . |
| Light | रेवती <i>Reoti</i> . |
| Dark | अश्विनी <i>Aswini</i> or असनी <i>Asni</i> . |
| Light | भरणी <i>Bharni</i> . |
| | क्रितिका <i>Krittika</i> . |
| Dark | रोहिणी <i>Rohni</i> or रोहिनी <i>Rohini</i> . |
| Light | मिर्गाशिरा <i>Mirgaira</i> or मिर्गिडाह <i>Mirgidāh</i> . |
| Dark | आर्द्रा <i>Aradra</i> or अद्रा <i>Adra</i> . |
| Light | पुनर्वसु <i>Punarbas</i> . |
| Dark | पुष्य <i>Pukh</i> or चिरैया <i>Chiraiya</i> . |
| Light | अश्लेषा <i>Asres</i> or अश्लेखा <i>Aslekha</i> . |
| Dark | मघा <i>Maggha</i> . |
| Light | पूर्वा फगुनी <i>Purba Phaguni</i> . |
| | १ of उत्तरा फगुनी <i>Utra Phaguni</i> . |

1083. The year current in Bihar is the *Fasli* year, which commences with the Hindu month of *Āsin*. The year is also popularly* divided into three seasons, viz. the hot (बरसाती *garasāī*), the wet (बरखा *barkha*), and the cold (जारा *jāra*). The hot season commences in फागुन *Phāgun*, the wet in अषाढ़ *Akhārāh*, and the cold in कतिह *Kātik*. The following rhymes, some of which will be found also in Carnegy's *Kachahri Technicalities*, are current over the greater part of Northern India, and show the various seasons for agricultural operations.

1084. Cultivation commences in Jeth, in the asterism of Rohini, when ploughing and sowing begin. The rain of Mirgsira is not good, and hence no sowing is done in that asterism. In Aradra sowing is recommenced and transplanting is done for the winter (*aghani*) crop. This goes on into Punarbas and Pukh if the rains are late. In Magha and Purba Phaguni the *wrid*, *kurthi*, and other pulses are sown. In Hathiya rain is very important, both for the winter crops and for the sowing of the spring (*rabbi*) crops. In former days (say cultivators) the rains used to stop in Swāti, which was very good for the crops, but now they end in Hathiya. So valuable is the rain of Swāti that any drop which falls during that asterism into a pearl-oyster becomes a pearl. That is how pearls are made. The rain in Chitra, on the contrary, is very bad.

मग्घा लगवे बग्घा, सिवाती लावस टाती ।
कचनारी हाथी रानी, हम हूँ आवत बाती ॥

Maggha lagāve ghaggha, sivāti lāvas tāti,
Kahtāri Hāthi rāni, ham hū̄ avat bāti.

—Maggha brings rain-storms, Swāti brings a screen (i.e., rain-stops), and Queen Hathiya tells (by her thunder) that she is coming.

फागु करार चैत चुक किरतिक नइहि तार ।
साती नइहि माक तिह कहि नइ हाक गोचार ॥

Phāgu karāi, chait chuk, kirttik natthahi tār,
Swāti natthahi mākh til, kahi gae Dāk Godr.

* Astrologers and poets count six seasons, but the above is the popular division.

—If it rains in the month of Phāgun, *wrid* is spoilt; if in the month of Chait, lemons;* if in the asterism of Krittika, the toddy palms; and if in that of Swati, beans and sesamum, saith Dak, the Gowala.

जौं बरसे बैसक्खा राऊ ।
एक धान में दोबर चाऊ ॥

Jauñ barse Baisakha rau,
Ek dhān meñ dobar chāu.

--If King Baisākh (April-May) rain, every grain of paddy will produce two of rice.

क्रित्तिका चूए चौ के चूए ।
जौं रोहिनी नाहिं कादो करे ॥

Krittika chūe chhau ke chūe,
Joh Rohini nahin kādo kare.

—If it rains in Krittika, there will be no rain for the six following asterisms, provided Rōhini makes no mūd.

Krittika is the best asterism for sowing *china* (*panicum frumentosum*): hence they say in Tīrhut—

जब जनिहठ खरचाक चीन ।
क्रित्तिका में तू बीरचठ चीन ॥

Jab janiha kharchāk hīn,
Krittika meñ tūh boiha chin.

—If you find your stock of food becoming exhausted, sow *china* in *Krittika*.

मिरगसिरा तबच रोहिनि लबच अरदरा जाय बद्बुदाय ।
कहे डक सुनु भिल्लरि कुता भात न चाय ॥

Mirgsira tabay Rohini labay aradra jāy budbudāy
Kahai Dāk sunu Bhillari, kutta bhāt na khay.

—If *Mirgsira* is hot, *Rohini* rains, and *Aradra* gives a few drops, saith Dak, hear, O *Bhillari*, (rice will be so plentiful that) even dogs will turn up their noses at it.

* चूक *chuk* is a mess of lemons kept for fermentation, and is here applied to the fruit on the tree.

1085. The rain of Aradra (middle of June) is of considerable importance to the future crops : thus—

अरद्रा मंस जे बोए चाठी ।
दुख के मार निकाले चाठी ॥
Adra māns je boe sāthi,
Dukh ke mār nikāla lathi.

—If you sow sixty-day rice in Aradra, you strike distress with a club and drive it away.

आदि न बरसे अरद्रा बस न बरसे निदान ।
कहहिं दाक सुनु भिल्लरि भए किसान पिदान ॥
Ādi na barse aradra, hast na barse nidān,
Kahahiñ Dāk sunu Bhillari bhāe kiśān piśān.

—If Aradra does not rain at the commencement, and Hathiya at its end, saith Dāk, hear, O Bhillari, the cultivator is crushed.

And—

चरहा बरसे अरद्रा उत्तरत बरसे बस ।
कतेक राजा दाने, रहे अनन्द गिरहास ॥
Charhat barse aradra, utrat barse hast,
Katek rāja dāne, rahe anand girhast.

—If it rain when Aradra commences and when Hathiya is ending, no matter how much rent may be demanded, the householder is still happy.

अरद्रा बरसे सब किछु चाँ ।
एक जवास पतर बिन भाँ ॥
Aradra barse sabh kichhu hān
Ek jawās patr bin bhān.

—If Aradra rains everything grows (*lit. is*): only one, the *jawās* (*Hedysarum alhagi*), loses its leaves.

1086. Aradra and Punarbas are the two main asterisms of the month of Akhārḥ (June–July). This is the great month of the year for finishing the preparation of the fields, as the proverb says, जेकर बजस चखदन्ना रे तेकर बारहो मास *jekar banal akharwa re tekar bāraho māś*, —he whose fields are ready in *Akhārḥ*, is ready also all the year round. If the rains are late, paddy sowing goes on as late as Punarbas or even Pukh, but this is rarely successful. These last two asterisms are usually devoted to transplanting, and not to sowing.

पुख पुनरबस बोए धान ।
मग्घा असलेखा कादो धान ॥

Pukh punarbas boe dhān,
Maggha aslekha kādo sān.

—Sow paddy in Pukh and Punarbas, and in Maggha and Aslekha mix thoroughly the mud (*i.e.* prepare the fields).

अरदरा धान, पुनरबस पेसा ।
नेस, किसान, जे बोए चिरैया ॥

Aradra dhān, punarbas paiya.
Gel, kisān, je boe chiraiya.

—Paddy sown in Aradra turns to plenty, in Punarbas it has empty ears, and sown in Pukh it turns to nothing.

1087. After Akharh (June–July) comes Sawan or Saon (July–August), to which the following rhymes apply :—

साखोन सुक्का सप्तमी अपि जे अत्रिई मान ।
दौं बनि मेवा बरसे जौं लगि देव उठान ॥

Sāon sukla saptamī chhapi kai ūgahīñ bhān.
Tauñ lagi megha barse jauñ lagi deb ūthān.

—If on the morning of the seventh day of the bright half of Sawan the sun rises obscured by clouds, it will rain up to the festival of the *Deb Ūthān* (11th of the light half of Kātik, *i.e.* early in November).

साखोन सुक्का सप्तमी उज के लूकहिं छर ।
हाँको पिवा हर बरद बरका नेस बड़ि दूर ॥

Sāon sukla saptamī, ug ke lūkahiñ sār,
Hānko piya har barad, barkha gel bari dūr.

—If on the same day as that above mentioned the sun rises (clear) and afterwards hides itself behind clouds, drive away, my dear, your plough and bullocks, for the rain is very far off.

साखोन सुक्का सप्तमी, उदे जौं देखे मान ।
तुम जाओ पिवा माँहवा हम जेवों सुखन्तान ॥

Sāon sukla saptamī, udai jōñ dekhe bhān,
Tum jāo piya Māhoa, ham jāboñ Multān.

—A cloudless morning on the same day (is a sure sign of drought). My dear (let us leave the country,) I am going to Multan, and you can go to Malwa.

बाबोम सुकला सप्तमी रेमि होँहि मसियार ।
कच मजुर सुहु मजुरि बरबरे उपजव वार ॥

*Sāon sukla saptami, raini hoñhi masiyār,
Kah Bhaddar sunu Bhaddari, parbat upjay sār.*

—If on the same date the night is dark, saith Bhaddar, hear, O Bhaddari, excellent crops will grow even on a mountain.

बाबोम सुकला सप्तमी, जोँ गरजे खावी रात ।
तुम जाओ पिवाँ माँहवा, वन जेवोँ हुजरात ॥

*Sāon sukla saptami, joñ garje ādhi rāt,
Tum jāo piya Māhwa, ham jaibon Gujrat.*

—If on the same date it thunders at midnight (there will be a drought), you must go to Malwa and I to Gujrat.

करके भोजे कंकरी, सिङ्ग गरजे जाग ।
कच मजुर सुहु मजुरि कुमा मात व जाग ॥

*Karke bhinjai kankri, singh garjai jāe,
Kah Bhaddar sunu Bhaddari, kutta bhāt na khāe.*

—“If in Cancer (Sawan, July-August) the gravel is wet, and Leo (Bhādon, August-September) passes by with thunder,” saith Bhaddar, “hear, O Bhaddari, rice will be so plentiful that even dogs will refuse it.”

बाबोम पछवा भादव पुरवा आसिन बरे ईसान ।
कातिक कन्ना सिक्किओ न डोले कतव के रकवई धान ॥

*Sāon pachhwa, Bhādob purwa, Āsin bahe isān,
Kātik, kanta, sikio na dole katay ke rakhbah dhān ?*

—If the west wind blow in Sawan, the east in Bhādon, and the north-east in Āsin, and if there is so little wind in Katik that even the reeds do not shake, where, my dear, will you have room to keep your rice? (i.e., you will have a bumper crop).

बाबोम मास बहै पुरवेया बँचव वरद कोनव मैया ।

Sāon mās bahai purvaiya, benchah barad kinah gaiya.

—If the east wind blow in Sawan, sell your bullocks and buy cows (it will be no use trying to plough).

साधोनक पक्षका दिन दुर वारि ।
 चूल्हिक पाशा उपजे वारि ॥

Sāonak pachhwa dīn dūr vāri,
Chūlhik pāshā upje vāri.

—If the west wind blow in Sāwan for only two or three days, rice will grow even behind your hearth.

साधोन पक्षेचा मरि मरे ।
 भादों पुरवा पथल सरे ॥

Sāon pachhea mahi bhare,
Bhādoñ purva pathal sare.

—If the west wind blow in Sāwan, the land will be flooded; and if the east wind blow in Bhādoñ, (it will rain so that) the very stones will melt.

जे न मरे अखरेचा मग्गा ।
 पेर मरे अखरेचा मग्गा ॥

Je na bhare Asrekha Maggha,
Pher bhare Asrekha Maggha.

—That which is not filled up with water in Asres and Maggha has no chance of being filled up till they come again next year.

1088. To Bhādoñ (August–September) the following apply:—

South Munger—

पुरवा सेवे पूर किसान ।
 आधा बरती अथा बरक ॥

Purva seve pūr kesān,
Ādha ghaghri ādha dhān.

—If a cultivator does not finish transplanting before Purwa (i.e. Purba Phaguni), half his crop will be paddy and half chaff.

जों पुरवा पुरवेचा पावे । सुखळे मरिवा भाचो बघावे ॥

Jāñ purva purvāchā pāve, sukhlē marivā bhāchō bāghāve.

—If the east wind blows in the asterism of Purwa (i.e. Purba Phaguni), there will be so much rain that ships will float in the dried-up beds of rivers.

Closely connected with this is the following :—

पुरवा पर जीं पचना नहै । बिहँसि रीकू बाव करे ॥
प्रह दोनों के रहै विचार । ज बरवै ई करे भतार ॥

Purwa par jāñ pakhwa bahai, bihañsi rākr bāt karai,
Ek donoñ ke ihai bichār ā barsai ī karai bhatār.

—If the west wind blows during Purwa, and if a widow chats and smiles, from these facts you may judge that in the first case it will rain, and in the second case she is going to marry a second time.

With this may be compared—

डीरि पक मेघा नहै, ओ विपना सुदुकाए ।
कहे दाक सुनु दाकिनि, ज बरवै ई जाए ॥

Tīrī pakh megha nre, o bidhwa musukāe.
Kahe Dāk sunu Dākini, ā barse ī jāe.

—“When the clouds fly like the wings of the partridge, and when a widow smiles,” saith Dāk, “hear, O Dākini, the one is going to rain and the other to marry.”

सक करे बदरी सनीवर रहे जाए ।
ऐसन बोले भदुरि बिन बरसे नहिं जाए ॥

Sūk kare badri sanīchar rahe chhāe,
Aisan bole Bhaddari bin barse nahī jāe.

—A cloudy sky on Friday and Saturday is a sure precursor of rain.

साखीन के पुरवा, भादों पकिना जोर ।
बरवा बँचठ सानी, बलठ देस का जोर ॥

Sāon ke purwa, bhādoñ pachhima jor,
Bardha bencha sāmi, chala des ka or.

—My husband, let us sell our bullocks and leave the country if there is east wind in Sāon and a strong west one in Bhādoñ.

The following is current in Tirhut :—

कुसी आमवास चौठी चान ।
अब की रोपवठ चान किसान ॥

Kusi amāwas chauthi chān,
Ab ki ropva dhān kisan.

—After the *Kusi Amāwas* (the festival of the 15th Bṛhadon, on which Brāhmins dig *kus* grass), and the *Chauk Chanda* (the moon of the 19th of Bṛhadon, O cultivator! you needs not plant out paddy.

उतरा में जनि रोपह भैया ।

तीन धान होए तेरह पैया ॥

Utra meñ jani ropahu bhaiya,

Tin dhān hoe terah paiya.

—Do not transplant in Utra Phaguni, for you will only get three grains to thirteen empty husks.

रातुक कागा दीनुक सिघार ।

कि करी बादर कि उपदार ॥

Rātuk kāga dīnuk siyār,

Ki jhari bādar ki uptār.

—If the crow speak by night, and the jaokal by day, there will be either a rain-storm or an inundation.

बौबा बौबा बसे बतार ।

तब होबा बरबा के बास ॥

Aua baua buhe batās,

Tab hola barkha ke ās.

—When the wind blows from all four quarters, there is hope of rain.

1089. To Āsin (September–October) the following apply:—

बधिवा बरसे तीन होत बा, सक्कर, साही, मास, ।

बधिवा बरसे तीन जात बा, तील, कोदो, कपास ।

Hathiya barse tin hot bā, sakkar, sāhi, māś,

Hathiya barse tin jāt bā, til, kodo, kapās.

—Rain in Hathiya produces three things,—sugar-cane, rice, and pulse; and destroys three things,—sesamum, *kodo*, and cotton.

With this may be compared—

बदरा गेल तीन गेल, सन साठी कपास ।

बाधिवा गेल सन गेल, बानिस पाबिस बास ॥

Adra gel tini gel, san, sāthi, kapās;

Hathiya gel sabh gel, āgil pāchhīl chās.

- Want of rain in Aradra destroys three crops,—hemp, sixty-day rice, and cotton. But by want of rain in Hathiya every thing is ruined, both what has been sown and what will be sown.

बहिवा बरिसे, चितरा मँकराय ।

घर बैसे धनधा रिरिवाय (or धनराय) ॥

Hathiya barise, chitra mehrrāy,

Ghar baise dhanha ririyāy (or agrāy).

- If Hathiya rains, and (the clouds of) Chitra hover about, the paddy-cultivator sits at home and utters cries of joy.

चितरा बरसे माटी मारे ।

बागे मार गेरु के कारे ॥

Chitra barse māti māre,

Āge bhāi gerui ke kāre.

- Rain in Chitra destroys the power of the soil and is likely to produce blight.

बाधा बिना रार मुरार ।

बाधा बिना जौ केरार ॥

Ādhā Chitra rāi murāi.

Ādhā Chitra jau kerāi.

- In one-half of Chitra sow mustard and radishes, and in the other half barley and pease.

1090. To Katik (October–November), the following apply :—

एको पानि जो बरसे खाती ।

कुरमिन पहिरे सोना पाती ॥

Eko pāni jō barse Swāti,

Kurmin pahire sona pāti.

- If a single shower come in Swati it enriches people so much, that even Kurmi women get golden earrings to wear.

बैद बिदित ना होखे धान । बिना तुला नहिं पूडे धान ।

सुख सुखराती देव उठान । तकरे बरहै करार नमान ॥

तकरे बरहै खेत बरिधान । तकरे बरहै कोठिए धान ॥

Bed bidit na hokhe ān, bina Tula nahin phūtai dhān,

Sukh sukh-rāti deb ūthān, takrai barhai karah nemān,

Takrai barhai khet kharihān, takrai barhai kothie dhān.

—What has been written in the Vedas cannot happen otherwise, and paddy cannot ripen before the balance (*i.e.* *Libra* = *Kātik* = October–November). . From the festival of the *Sukhrāti* (*i.e.* the *Diwāli*) to the *Deb Uthān* (11th of the light half of *Kātik*) there will be happiness. On the twelfth day after that, hold the festival of eating the new grain; on the twelfth after that, heap up the corn on field and threshing-floor; and on the twelfth after that, put the grain in the store-house.

1091. The following are the signs of the stoppage of the rains:—

ब्रह्म के उगने तो क्या भये, निरमल रैनि करण ।

कौये जल देखिबठ सगरा, कामिनि रूप भरण ॥

Chhap ke ugai to kya bhaye, nirmal raini karant,

Kiye jal dekhiha sagra, kāmīni rūp bharant.

—It matters little if the sun rises obscured by clouds, because when the nights are clear (the rains will stop). You will only find water in the sea, and women will have to go to the wells for water.

रात निबद्ध, (or रातुक चकमक) दिन के च्छा ।

कहेँ पाव जे बरखा न्हा ॥

Rāt nibaddar (or rātuk chakmak), din ke chhaya,

Kaheñ Ghāgh je barkha gaya.

—If you see a cloudless night and a cloudy day, be sure, says Ghāgh, that the rains are at an end.

बोझी लुहरी, फूले कास ।

बाब नाहीं बरखा के कास ॥

Boñhi lukhri, phūle kās,

Ab nāhiñ barkha ke kās.

—The barking of the fox and the flowering of *kās* grass are signs of the end of the rains.

उगे अगस्त बन फूले कास ।

बाब नाहीं बरखा के कास ॥

Uge agast ban phūle kās,

Ab nāhiñ barkha ke kās.

—The appearance of the star Canopus and the flowering of the *kās* grass in the forest are signs of the end of the rains.

काँची कुँसी चौठ के चान ।
चब का रोपवठ चान किसान ॥

. *Kānsī kūsī chauth ke chān,*
Ab ka ropba dhān kisan.

—If the *kās* grass and the *kūs* grass flower on the fourth of the light half of Bhādon, why do you plant out, O cultivator (for the rains are stopped) ?

1092. The following refer to the dry season :—

अगहन दोबर, पूस चौदा ।
माघ सवार, फागुन बरसे घर हू के जाटे,
Aghan dobar, Pūs dyaurha,
Māgh sawāi, Phāgun barse gharhu ke jāi.

—If it rains in Aghan, you will get double an average crop; if in Pūs, one and a half; if in Māgh, one and a quarter: but if in Phāgun, then even (the seedlings which you brought from) your house will be lost.

अगहन जे बरसे मेघ,
धन खो राजा धन खो देस ॥
Aghan je barse megh,
Dhan o rāja dhan o des.

—Happy are the king and people when it rains in Aghan.

पानी बरसे चाचा पूस ।
चाचा गेहूँ चाचा भूस ॥
Pāni barse adha Pūs,
Adha gehūñ adha bhūs.

—Rain in the middle of the month of Pūs (i.e. early in January) will give you half wheat, half chaff.

माघ के गरमी, जेठ के जाड़, ।
पहिवा पानी भर गेहूँ ताड़ ।
घाघ कहेँ हम खोबीँ जोमी ।
कुँसी काँ पानी धोरहेँ धोबी ॥
Māgh ke garmi, Jeth ke jār,
Pahila pāni bhar gehūñ tār,
Ghāgh kahen ham hobauñ jogi,
Kūsān kā pāni dhoihen dhobi.

—Heat in Māgh (January–February), cold in Jeth (May–June), and the tanks filled with the first fall of rain (are signs of a drought). I'll become a beggar, says Ghāgh, and the washermen will wash with well-water.

पेन के पछेवा भादों के पछा ।

भादों के पछेवा माघ के पछा ॥

Chait ke pachhea, Bhadoñ ke jalla,

Bhadoñ ke pachhea, Māgh ke palla.

—The west wind in Chait (March–April) means rain in Bhādoñ (August–September), and the west wind in Bhādoñ means frost in Māgh (January–February).

1093. It will now be of advantage to compare the above with a native account of the behaviour of the asterisms preceding the famine of 1873-74. The poet Phatūri Lāl, in his tale of the famine, says as follows:—

June 1873.—ROHNI is the first asterism of the rainy season; but,

Rainfall in Tirhut about
4 inches.

as it came, it departed without rain.

MIRGSIRA fulfilled our hopes, for it gave a few drops of rain and departed.

July.—ARADRA passed by with great majesty, thundering on every side.

Rainfall about 6½ inches,
of which 4 inches were
in the second week and 1½
inches in the last week.

PUNARBAS is a very holy asterism, but it was also a miser.

PUKH saved the face of the earth, but it became the end of the rains.

August.—ASRES rained upon such of the seedlings as did rise.

Rainfall about 4½
inches.

MAGHA was as poor as a beggar.

September.—PURBA PHAGUNI gave no proof of his existence by rain.

Rainfall about 4 inches.

UTRA PHAGUNI did not give even a drop to swear by.

October.—HATHIYA was like an elephant (*hāthi*) who put his trunk in his mouth.

Rainfall nil.

CHITRA was only a robber and a murderer.

November.—SWĀTI was put to public disgrace.

Rainfall nil.

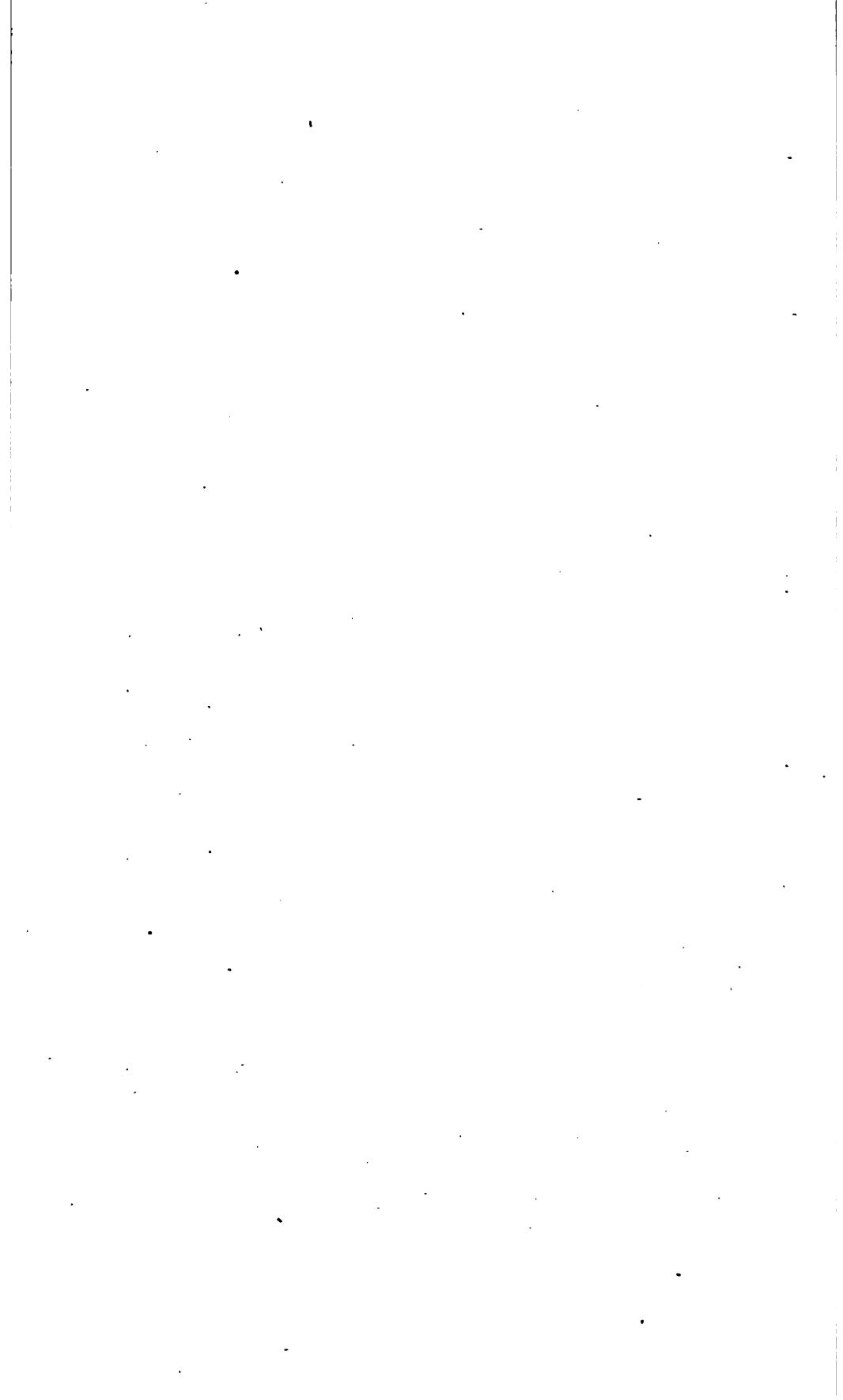

DIVISION VII.

CATTLE AND OTHER DOMESTIC ANIMALS.

CHAPTER I.—CATTLE GENERALLY.

1094. Cattle generally are known as मवेशी *māveshī*, मास *māl*, or मास मास *māl jāl*. Other names are चौसा *chau* north of the Ganges, दूर *dhūr* in Patna and Gaya, and बरधा *baradhā* in South-West Shahabad. A head of cattle is रास *rās*, and in Patna and Gaya also दूर *dhūr*. Horned cattle, exclusive of buffaloes, are गोरु *goru* or मास गोरु *gāy goru*; also दूर दंगर *dhūr dāngar* in Patna and Gaya. In Sāran दंगर *dāngar* means cattle worn out from old age. In North-East Tirhut they are called लाल *lāl*. A worn-out, useless cow or buffalo is said to be टुटा *tutā* or टुट गेस *tūt gail* north of the Ganges, or in North-West Tirhut बेहवाल *behwāl*. In Patna the term is थीसा *thausa*, in Shahabad थहसल *thahusal* or चौसल *thausal*, in Gaya नकादर *nakādar*, and in South Bhagalpur उथानो *uthāno*. Dead cattle are दंगर *dāngar* in Shahabad and मरी *mari* in East Bihar.

CHAPTER II.—BULLS.

1095. A bull is सँह *sānrh* when branded with sacrificial marks and let go, and धाकर *dhākar* when not so branded. चौभर *chaubhar* (Patna and Gaya) or धाकरगोह *dhakarchhoh* is an imperfectly castrated bull, and बिहामो *binhāmo* is a bull to the south-east.

CHAPTER III.—BULLOCKS.

1096. A bullock is बरध *baradh*, also in Patna, North-West Tirhut, and in Shahabad optionally बरद or बरुद *barad*. To the west it is also called बैल *bail*, and in Gaya दूर *dhūr* or पैरा *paira*. Plough-bullocks are called हराथी *harāthī* to the east. The pair are called जोड़ा *jora*. In a team of three bullocks the wheelers are called दूरी *dhūri*

or घुरिया *dhuriya* to the west, and जोड़ी *jori* to the east. The leader is बीर *binr* or बिंरिया *binriya* to the west, and जिही *jhitti* or नाटा *nāta* to the east.

1097. A yoke of well-bullocks is called मोठ्ठा बरब *motha baradh*. The bullock which works blindfolded in an oil or sugar-cane press is called नाटा *nāta* or कोखुवा बैल *kolhua bail*. When there is ploughing going on or a cart being pulled by the aid of three bullocks, of whom only two are yoked at a time while the third one rests, the three are called तेधुरा *tedhura* or (in East Tirhut) तेधरी *tedhri*, or in Patna टेपटा *tepta*. Similarly when there are four bullocks, of whom two rest while two work, the team is called चौकर *chaukhar* or चौकरिया *chaukhariya* or चरबर्दा *charbardha*, or in South-West Tirhut फेरवार *pherwār*. In the case of ploughing, the boy who looks after the unemployed bullocks is called in North-East Tirhut अनवाह *anwāh*.

1098. Bullocks are distinguished by various peculiarities, such as the following:—

A bullock unbroken to work is अदारी *adāri*, also अदर *adār* in Tirhut, in Shahabad, and in South Bhagalpur. In Patna and Gaya he is औदार *audār*, in South Munger अबौ *abō*. One that sits down at work is परवा *parua* to the west, and north of the Ganges कोहि *korhi*.* In South-West Shahabad he is गरियार *gariar*, in Shahabad and Gaya गर *gar*, and in Patna मन्कोही *mankorhi*. A vicious bullock is मरकाह *markhāh*, also मरकाहा *markhanda* in Patna, मरकाहो *markhanno* in East Bhagalpur, and मरकाह *markhan* in Gaya. In South-West Shahabad the words मरकाहा *markaha* and लथा *latha* are used. A shying bullock is फेफरियाह *phephriyāh* to the north and west, and चिहुकार *chihukār* or चरकाह *harkāh* north of the Ganges generally. In South-West Shahabad he is बंदिया *bandiya*, in the rest of the district मन्हार *manjhār*, in Patna and Gaya मरकाहा *bharkaha*, and to the south-east हरकाहा *harkāha*. To butt is डरपेटल *hur petal* in the west and मारब *mārab* in Tirhut. In Patna and the east it is डूस मारब *dhūs mārab*, and to the south-east डूस मारब *dhūs mārab* or डूसा मारब *dhūsa mārab*. In Gaya it is दुसियाग्र *dhusiyāēb*, and such a bullock is दुसमार *dhusmār* or दुसियाहा *dhusiyāha*. To break in cattle is तेवारे जोतल *tewāre jotal* to the west. In Tirhut it is पाट लमाग्र *pāt lagāēb* or जोतब *jotab*. In East Tirhut it is पाट गुमाग्र *pāēt ghumāēb*, and in Gaya पीरी में जोतब *pīri meñ jotab*. In Shahabad निकासल *nikāsal*, in Patna लवनाग्र

* Compare the proverb कोहि बरब के फेफि बहुत *korhi barad keñ phephari bahut*,— it is the lazy bullock that snorts and shies.

daghræb, in Gaya दगहराएव *dahræb*, in South Munger गोहराएव *gohræb*, and in South Bhagalpur हटियाएव *chhatiyæb*, mean to cause an animal to get up and to drive it along a village-road.

1099. A stunted bullock is ननकिरवा *nankirwa*, नटा *nata*, or नटवा *natwa*. A dwarf bullock is गैवा *gaina*.

1100. A bullock whose horns project in front is चोंपा *ghoncha* north of the Ganges and in Patna and South Bhagalpur, also चोंपा *ghompa* in East Tirhut. In Shahabad it is चोंपवा *ghonchwa*, in Gaya चोंघर *ghonghar*, in Patna also चोंगरा *ghongra*, and in South Munger चोंघरा *ghonghra*.

1101. A bullock one of whose horns is erect while the other hangs down is सरगपताली *saragpatāli* (literally pointing to heaven and hell) or सरङ्गपताली *sarangpatāli*. He is also called देव *deb* in Champāran and West Tirhut, कंसपुरी *kansāsuri* in South-West Shahabad, पताल सिंघी *patāl singhī* to the south-east.

1102. A bullock whose horns join in the centre is गोसिंघी *gausinghī* in South-West Tirhut, and सिंगजुटा *singjutta* or सिंगजूटव *singjūtal* generally.

1103. A bullock whose horns are loose and are turned down is called मैवा *maina*, or in Patna and the south-east मैव *main*.

1104. A bullock whose horns are curled like a ram's is भैरवा *bheirwa*, भैरु *bheir*, or भैरवा *mendhwa*.

1105. A bullock one of whose horns turns to the right and the other to the left is चतर *chatar*, or चतरा *chatra* when they are small and flat. When they are large, he is called फाथ *phathāh* or फाथा *phatha*. In North-East Tirhut he is फरकवाड़ा *pharakjhara*.

1106. A bullock with stunted horns is मुथरा *muthra* or मुथिया *muthiya* generally, but in Shahabad it is मुथाव *muthal* or मुठव *muthail*, and in Gaya मुथरिया *muthariya*.

1107. A bullock with no horns is मुंरेवा *munrera* in Saran, मुण्डा *bhunda* in Champāran, भूवा *bhūra* or भुंरवा *bhunrwa* in Shahabad, भूवा *mūra* in North-East Tirhut, and मुण्डा *munda* in Gaya and the rest of Tirhut, मुण्डा *murla* in South-East Tirhut, Patna, and South Munger, and मूरा *mūra* in South Bhagalpur. Other names are मुंरिया *dumriya* in South-West Shahabad and ठठा *thatha* in South-East Bihar.

1108. A bullock with only one horn is *प्रबन्धिना eksingha* or *सिंघतुता singhtutta*.

1109. When a bullock has a broken tail he is called *बाँदा bānra* or *बाँदा bānra* north of the Ganges and to the south-west, also *बाँदा nārha* in East Tirhut and the south-east. In Gaya and Champāran he is *बन्दा banda*, and in Patna *लन्धा landha* or *बन्धा bandha*. In South Munger he is *लान्धा lānrha*. The opposite to this is *पौचन्धाका ponchhwāla*.

1110. A bullock with its ears covered with long hair is *काबर kábar* to the east and *जबन्ना jhabhra* to the west. One with crooked eye-brows is *भौसाँ डेर bhauśāñ ter* or *भौसाँ डेर bhauśāñ der*, also in South Munger *बाँसाँ डेर bhāśāñ dera*.

1111. A bullock not used for agriculture because it has excrescences (representing Shiva) on its body, but purchased by religious mendicants, is known as *जटाता jataha* or *बसाहा basaha*. Other local names are *जठनावा jathāwa* in Shahabad and *जठो jato* in South Bhagalpur. It is the bullock ridden by Shiva.

1112. A *चैरवा chherua* or *बधिया badhiya* is a castrated animal, as distinguished from the *साँह sānrh* or entire bull devoted and let go. The sacred marks placed on this last are the *तिरन्धल tirsul* or trident and the *चक्कर chakkar* or discus.

1113. The following rules for selecting cattle are current throughout Bihar :—

बैल बेसाहे बसबब बन । बैल बेसबिब दू दू दन ॥
 बाब बसौटी साँबोर बाब । देबादि किमिब बति बाब ॥
 जब देखिब रूपबौर । डाका बारि होब उपरौद ॥
 जब देखिब मैना । तब प्रदि पार सँ करिब मैना ॥
 जब देखिब बेरिवा मोल । उठ बेठ कै करिब मोल ॥
 जब देखिब करिवा बन । कैसा मोका देखब जहू दन ॥

Bail besāhai chalalah kant, bail besakiha dū dū dant,

Kāchh kasauti sāñor bān, ð chhāri kimiba mati ān.

Jab dekhīha rūpadhaur, tāka chāri diha uparaur,

Jab dekhīha maina, tab ehi pār san kariha baina.

Jab dekhīha bairiya gol, uth baith kai kariha mol,

Jab dekhīha kariyawa kant, kaila gola dekhah janu dant.

—My dear, you have started to buy a bullock, be sure and buy one with only two teeth. Do not buy any which is not some shade of grey; but if you see a pure white one, you may

advance your price four rupees. If you see one with loose horns, give handsel without crossing the road (to look at it more carefully, *i.e.*, it is sure to be a good one). If you see one with a red head and a light red body, don't buy till you have had a good look at it. But, my dear, if you see a black, or a yellow-grey, or a red one, don't take the trouble to look at its teeth.

The following is a warning against two kinds of bullocks :—

उरग पताली भौंवाँ डेर ।

अपन खाच, परोसिया डेर ॥

Sarag patāli bhauñāñ ter,

Appan khāy parosiya her.

—A bullock with horns pointing up and down, or one with crooked eye-brows, injures its master and the neighbours as well.

CHAPTER IV.—COWS AND BREEDING.

1114. A cow is नौ *gau* or गाव *gāy*. One that has had one calf is known as a पहिलोट or पहिलौठ गाव *pahiloṭh* or *pahilaunth gāy*. Sometimes these words are spelt with *t* instead of with *th*. A cow or buffalo within six months after calving is डेन *dhen* generally. In North-East Tirhut it is डेइन *dheün* or डेनु *dhenu*, in Patna and the south-east डेनु *dhenu*, and it is also डेनु *dhenu* in Patna. After this she is बकेन *baken*, or (in Shahabad and the south-east) बकेना *bakena*. A cow that calves yearly, or that never stops milking, is पुरहिवा *purāhiya* north of the Ganges. A cow that breeds when five years old is पचाड़ *pachār*. In Shahabad and Patna she is धनपुरही *dhanpurahi*, in Patna (also), Gaya, and South Munger बरन्सारन *barsāin*, and in South Bhagalpur पोरैया *poraiya*. A barren cow is बहिला *bahila* generally, also डहन्ना *thahra* in South-West Shahabad.

1115. To be covered by a bull is बरन्धिवाग्रव *bardhiyāëb* or परिवाग्रव *pariyāëb*, and also south of the Ganges बरन्दाग्रव *barddāëb*. Another general term is पाख वाग्रव *pāl khāëb*. To copulate (of animals) is बाहव *bāhab*, also in North-East Tirhut ओवाग्रव *ohāëb*. In regard to buffaloes, भैवाग्रव *bhainsāëb* may also be used, and of a goat बन्दाग्रव *chhagrāëb* to the west.

1116. A cow in calf is बरदाप्रक *bardāil* or गभिनि *gābhini*. In South Bhagalpur she is फरकी *pharki*. The act of calving is विवाज *biyān* or विवाजा *biyāna*. South of the Ganges जोल देव *jhol deb* is to give birth to a number of young, e.g. in South-West Shahabad a man was heard saying बजार बेरी दू जोल बचा दिखलस ईं *hamār ahheri du jhol bachcha dihlas ka*,—my goat has dropped kids on two occasions.

1117. A cow that is a good milker is दुधार *dudhār* or दुधारि *dudhāri**. One which gives milk for one and a half years is देवद *dewarh*, or in North-East Tirhut बरकु *barkhu*. A cow or buffalo that has gone five months in calf, or that has given milk for five months, is सखरोस *sakhros* north of the Ganges, and also पुरधिया *purāhiya* in North-East Tirhut. One that gives little milk is चौंही *chonrhi* or चौंद *chonrh*, also चोरनी *chorni*, and in Tirhut चौंछ *dhonchh*. In Shahabad it is नडधर *nathāhar*, and in South Bhagalpur चौंद *chaunr*. A cow that kicks at the time of milking is रककट *karkat*, or in Tirhut लथराह *lathrah*.

CHAPTER V.—CALVES.

1118. A calf as long as it is unweaned is लेह *leru*. A male calf is बाचा *bāchha*, बहवा *bachhwa*, or बहहू *bachhru*, and a female calf बाची *bāchhi* or बधिया *bachhiya* when they are from 1½ to 3 years old. When a calf has two teeth, it is दोदान *dohān* north of the Ganges and in Shahabad. In the rest of Shahabad it is दुदान *dudant*, and elsewhere दोदान *dotant* or दोदना *dotanta*. In West Tirhut it is दोक बैल *dokh bail*. When it has not yet got its true teeth it is called उदान *udant*, or to the east अदान *adant*. ओसर *osar*, or to the west कलोर *kalor*, is a heifer ready for the bull. In North-East Tirhut she is गौर *gaur*, in Patna फेटारन *phetān*, and in South Bhagalpur अंकरिया *ankariya*. In South-East Tirhut चैर *thair* is a two-year old heifer. Full-grown cattle are तैयार *taiyār*. In calculating roughly the age of pack-bullocks, the word मौल *taul*, or in Gaya पूर *pūr*, is used. Thus एक मौल *ek taul* or एक साल के मौल *ek sāl ke taul*, one year full-grown; दू मौल *du taul*, two years full-grown; and so on, the counting commencing from

* Cf. the proverb बाची तें किह पारै सधै कइर बेन; बाव खात चुचकार तें सधस इधारि बेन *jāhi teñ kihhu pārai, sahiai karui bain; lāt khāt chuchukār teñ sahas ihāri ben*,—from whomsoever you expect to receive benefits, you must bear abusive words; even while being kicked by a milch-cow, a man will endure its actions and pat it.

the time when the bullock has eight teeth, viz. when he is four years or more old. A calf with six teeth is called चहदँत *chhadant*. It is also called चहकड़ *chhakkar*, चहकड़ा *chhakra* (male), or चहकड़ी *chhakri* (female). Such calves are not appreciated, as in the proverb चुरा चरगा चहकड़ी *mul barda chhakri*,—as soon as a bullock is dead (it is abused and called) a *chhakri*. A calf with seven teeth is सतदर *satdar* or सतधर *satdhar* to the west, and सतर *sattar* elsewhere south of the Ganges, except South Bhagalpur, where it is सततर *satattar*. In West Tirhut it is सतदना *satdanta*. A calf with eight teeth is पूरा *pāra*, i.e. full-grown, or अचैव *adhail*.

1119. Coaxing a cow that has lost its calf to eat grain is called तोरिया *toriya*, or in South-East Tirhut घस्तुरिया *ghasturiya*. In South Bhagalpur it is called तोरियान *toriyān*. The same words are used for reconciling a cow or a buffalo to its newly-born calf by smearing the latter with sugar. A kind of hair string used for tickling a cow with a similar object is सेह *selh* or सेही *selhi*; and to do this is दानव *dānwal* in the north-west and सेहल *selhal* in South-West Tirhut. Sometimes the skin of the calf stuffed with hay is put before a cow which has lost its calf, especially at milking time. Salt is sprinkled on it and the cow licks it and lets her milk flow. The stuffed calf is called लगान *lagāwan* north of the Ganges. In South-West Shahabad it is called खलितड़ी *khalitāri*, in the rest of the district मौर *maur*, in Patna कर्ची *karchi*, and in Gaya कर्ती मुरी *karti mūri*. The kind of food given to cows when they calve is पकेव *pakheo* to the west and in Patna; also पकेवा *pakhewa* in South Munger. In North-West Tirhut it is चोहाट *chohāt* or चुहाड़ *chuhār*, and in North-East Tirhut चोहेर *chohair*. In South-East Tirhut it is महला *mahela*, and generally मसाला *masala*. In Gaya it is पुसडे *pustai*.

CHAPTER VI.—BUFFALOES.

1120. A male buffalo is भैंसा *bhainsa*, also महिसा *mahisa* in East Tirhut. A female buffalo is भैंस *bhains* or भैंसी *bhainsi*; also भैंरी *bhairi* north of the Ganges, and महिस *mahis* or महिसी *mahisi* in East Tirhut. A buffalo calf is पड़रू *parru* or कड़रू *karru*. A male buffalo calf is पाड़ा *pāra* or काड़ा *kāra*, and a female one पाड़ी *pāri* or काड़ी *kāri*. A well-known proverb is खेत महिसी चर, पड़रूदिं मार *khet mahisi char, parruhin mār*,—buffaloes are grazing in the fields, beat the calves, i.e., in a fight the smaller men get caught, and the richer and more powerful real

culprits get off. In Patna and the south-west *लोचर lochar* is a two-year old buffalo. In Gaya it is *तेवान tehan*. A buffalo with two teeth, i.e. three years old, is *पस pas*.

CHAPTER VII.—GOATS.

1121. A goat is *चेर chher* or *बकर bakkar*. A he-goat kept for breeding is generally *बोका boka*. General names for all male goats are *बकरा bakra*, *खसो khassi*, or *खसो khañssi*. Other terms are *खगर chhagar* or *बोकड़ा bokra* (North-East Tirhut), *बोनू botu* (Patna) or *बोबो boto* (South-East Bihar), *बीबड़ biyar* (South-West Shahabad), and *बिबहन biahān* (rest of that district). A she-goat is *बकरी bakri* or *चेरी chheri*, also *बनगरी chhagri* to the east. A castrated goat is specially *खसो khassi* or *खसो khañssi* in Tirhut and south of the Ganges. North of the Ganges the general name is *चेरवा chherua*.

1122. A kid is *पठरू pathru*. A male kid is *पाठा pātha* or *मेमना memna*, and a female *पाठी pāthi*, *पठिया pathiya*, or *मेमनी memni*. In South Munger it is sometimes called *बकरू bakru*. A goat kept for sacrifice is called south of the Ganges *पठरू pathru*, but when kept for other sacrifices it is called *खसो khassi*.

CHAPTER VIII.—SHEEP.

1123. A sheep is *भेड़ bheṛ*. A ram is *भेड़ा bheṛa* or (in South Bhagalpur) *भेड़ो bheṛo*, and a ewe *भेड़ी bheṛi*. A lamb is *भेड़िक बच्चा bheṛik bachcha*, also *पठरू pathru* and *बकरू bakru* in Tirhut. *मेमना memna* is also used in South-East Tirhut.

1124. A flock of sheep or goats is *जुड़ jhund* or *जूड़ jhūn*; also *जेड़ jer* in East Tirhut, *हेड़ her* in West Tirhut, and *जेड़ jel* in South Tirhut. A flock of about twenty is *लेड़क leṛkar*, and of about one hundred *बाग bag*. *गहेंड़ gahenr* is a still larger flock of four or five *बाग bag*. In South Bhagalpur *खरुहो kharuho*, and in South Munger *सहेर saher*, mean a flock of sheep.

CHAPTER IX.—PIGS.

1125. The general term is *सुगर sūgar* or *सुवर sūar*, also *डोका dhoka* in North-East Tirhut. Musalman villagers call them euphemistically

बद कौन *bad kaum*, or in North Tirhut and Patna बद कौन *bad.khoni* (*i.e.*, 'low caste'). Other similar names are हाराम *harām* in Gaya, and बद मोहरी *bad mohri*. A young pig is पाहुर *pāhur* to the east, also (male) डहुरा *dahra* north of the Ganges and in Gaya, टहुरा *tahra* in Shahabad, चौना *chhauna* in Patna and the west, and चावा *chhāwa* in Gaya. Female names are डहरी *dahri* (also in Gaya) or चाई *chhāi* north of the Ganges, and कुम्भी *kumbhi* in Gaya. A full-grown boar is पट्टा *pattha* or पट्टरा *pathra* in North-East Tirhut, and a full-grown sow is सोमनी *somni* in the same place. A pigsty is चौमार *khobhār*, or to the west चौमारि *khobhari*. In South-West Shahabad it is also चौमार *khobār*, in South-East Bihar it is खमार *khabhār*, and in Patna and Gaya it is बखोर *bakhor*.

CHAPTER X.—HORSES, MULES, AND ASSES.

1126. A horse is घोड़ा or घोरा *ghora*, and a mare घोड़ी or घोरी *ghori*. A common term for both is घोड़ or घोर *ghor*. South of the Ganges and in Saran another word for a horse or mare is चरवा *charwa*. A pony is टट्टू *tattu*, and a pony mare टट्टुआनी *tatuāni*, and also in Patna and Gaya मदिवान *madiyān*. A foal is बचेड़ा *bachhera*, and a filly बचेड़ी *bachheri*.

1127. To own a horse is a great piece of display according to Bihar ideas, as in the proverb देह गोट घोड़ी, नौ गोट चौख *derh got ghorī, nau got phauj* (spoken of one who makes display when he cannot afford it),—the owner of one and a half (*i.e.* two wretched) mares goes about (like a lord) with nine servants.

1128. An ass is गदगा *gadha*, a she-ass is गदगी *gadhi*, and an ass's foal गदगा के बच्चा *gadha ke bachcha*, or (in East Bihar and Shahabad) चौनी *chhauni*. An ass-driver is गदगाँकी *gadheāri*. A mule is खचड़ *khachchar*.

CHAPTER XI.—ELEPHANTS.

1129. An elephant is हाथी *hāthi*, a male elephant is पत्ता *hattha*, and a she-elephant हथिनी *hathini*, हथनी *hathni*, or (in East Tirhut) मेदनी *medni*, and in South-West Tirhut जोड़ी *jorhi*. A male elephant with small tusks is मकुना *makuna*. One with large tusks is पट्टा *pattha*.

1130. Elephants are tied up with a front foot-chain, which is बड़ी *beri* or पैकर *paikar*, and also in South-East Tirhut चहुवा *chhawa*. Its hind legs are chained with chains called दग्गी *daggi* or नङ्गर *nangar*, and also with a wooden hobble, called कठबन्धन *kathbandhan*.

CHAPTER XII.—CAMELS.

1131. A camel is ऊँट *ant*, also among Musalmāns शतुर *shatur*. Its young is called बोट *bota* in North-East Tirhut. Its nose-ring is नकेल *nakel*. कठरा *kathra* or काठी *kāthi* is its wooden saddle, also called पदान *padān* in North-East Tirhut; and नदेवा *gadela* or नदी *yaddi* is the pad.

CHAPTER XIII.—STRAYING OF CATTLE.

1132. To stray is generally घेरा जाग्र *hera jāḅ*; also in Saran बूजा जाग्र *bhūja jāḅ*. Other terms are अनेर *aner* (or अनेरना *anericā*) जाग्र *jāḅ* in North-East Tirhut, बहकल *bahkal* or भौरियाग्र *bhonriyāḅ* in Shahābad, and बहत जाग्र *bahat jāḅ* in Patna and Gaya. बधान *bathān*, and also in North-East Tirhut नोबाघ *goās*, is a cattle enclosure. Other words are घेरा *ghera*, हाठ *dhāth*, and हाठा *dhātha*. लम्बह *lambhab*, लामब *lāmbhab*, or लामब *lāmhab*, is to drive cattle into another's field to graze on the crops.

CHAPTER XIV.—COLOURS OF CATTLE.

1133. These are—

White.—This is चरक *charak* or चरका *charka*, with a variant चरको *charko* in South Bhagalpur. In Gaya it is रुपधौ *rupādhau*, and elsewhere also रुपधर *rupdhar* or रुपधौर *rupdhaur*. Another word is चमुरा *chamura* in North-West Tirhut.

1134. *Grey of various shades*.—धवर *dhawar*, धौर *dhaur*, or in Shahābad धावर *dhāwar*, is a light grey. सोकन *sokan* is a dark grey, कैल *kail* or कैला *kaila* is a yellowish grey or cream-colour, and सिलेबा *sileba* or सिलेबे *silebe*, reddish grey. सान्वर *sānwar* or सौरा *sāmra* is a black grey. कसौटी *kasauti* and काह *kāchh* are shades of grey.

1135. *Red*.—A reddish cow is गोल *gol*, गोला *gola*, or गोलवा *gohwa*. A dark red one is लाल *lāl*. A cow with a red head and the rest of the body of a lighter colour is बैरिया गोल *bairiya gol*. धुरगोलो *dhurgolo* is another shade of red in South Bhagalpur. महगोल *mahugol* means red like the *mahua* flower (*bassia latifolia*). In Shahabad this is महार *mahuar*, and in South Munger महलखा *mahulakha*.

1136. *Yellow*.—This is पीर *piar* or पिरा *piara*. गहमन *gahuman* or गोलमन *gohuman* is wheat-coloured.

1137. *Black*.—This is कारी *kāri*, करिया *kariya*, करिवा *kariyawa*, or (South Bhagalpur) करवा *karua*.

1138. A spotted cow is कौंस *kāns*, a brindle one बगच्छा *bagchhalla* (tiger-skinned), लाल बगच्छा *lāl bagchhalla* being a red brindle and सुफेद बगच्छा *sufhed bagchhalla* a white brindle. कर्कन्धा *karkandha* is one black on the shoulders. In Shahabad this is called करिकन्धा *karikandha*. सुवन्दार *guldār* is a spotted cow, and पाँच कलियान *pānch kaliyān* a piebald one, or more properly one with white stockings and a white blaze on the forehead.

CHAPTER XV.—HIDES.

1139. These are चमड़ा *chamra*, लाल *khāl*, or चरवा *charsa*. गौखा *gaukha* is raw cow's leather. It is also called गौटा *goita* north of the Ganges. भैंसौटा *bhainsauta* or (in South Bhagalpur) भैंसौठा *bhainsautha* is that of buffaloes. चाम *chām* is tanned cow hide. Sheep skins are खल्री *khālri*. A bullock's hide cut in two halves is आधा पारी *ādha phāri* or (North-East Tirhut) पंकी *phānki*. The hides of cattle which have died a natural death are मुरदारी *murdāri* or मुरन्दार *murdār*, and those of killed cattle हलाली *halālī*. साबर *sābar* is tanned deer skin. A depôt for hides is चरवा के गोदाम *charsa ke godām*. In South Munger चरवा *charsa* is a cess paid by tanners to the landlord.

CHAPTER XVI.—CATTLE SLAUGHTER.

1140. A slaughter-house is लोखाना *lokāna* in Champāran, मन्हार *manhar* in South-East Tirhut and Shahabad, and किलखाना *kilkhāna* in South-West Tirhut.

1141. Another name in Shahabad is *गुरदवान* *gurdawān*, and in Patna *खंड* *khānt*. Flaying and cleaning is *कमीना* *kamīna* or *कमाना* *kamāna*. A butcher is *कदार* *kasāi*, but a goat-butcher is *बकर-कदार* *bakar kasāb*, and a *चिक* *chik** or *चोक* *chik* kills both goats and sheep. The large knife used by them is *बोगडा* *bogda*, and also north of the Ganges *दबिया* *dabiya*. The block is *डेहा* *theha*, *कुन्दा* *kunda*, or *कुन्दी* *kundi*. In South-West Shahabad it is *खोर* *khōr*, and in South Bhagalpur it is *परकट्टो* *parkattho*. The string used for hanging up the animal to be flayed is *लोकाना* *lokāna*.

1142. A cultivator has many terms of abuse for his cattle. A favourite one is *जाब कसेवा खंडा* *jāb kasaiya khānta*,—may you go to the butcher, or to the sacrificial stake.

CHAPTER XVII.—FEEDING CATTLE.

1143. To chew the cud is *पगुरी* (or *पागुर*) *करव* *paguri* (or *pāguri*) *karab* north of the Ganges and in Shahabad. South of the Ganges generally it is *पगुराख* *paghurākh* or *पगुरी करव* *paghuri karab*. Local names are *पाज करव* *pāj karab* in Tirhut, *कोरी करव* *kori karab* or *कौरी करव* *kauri karab* in Patna and Gaya, and *गधडे करव* *gadhāi karab* in South Bhagalpur.

1144. Cattle fodder, consisting of the stems of the *जनेरा* *janera* (*Holcus sorghum*) and similar green stuff, is cut with a chopper (see §§ 86 and ff.), and is known as *कुट्टी* *kutti* or *कुटिया* *kutiya*. In South Bhagalpur it is *कुट्टरी* *kuttri*, and in Patna *कट्टा* *katta*. The fodder for stall-fed cattle is *गवत* *gawat* north of the Ganges. Other names are *लेहना* *lehna*—current in Shahabad, *गौत* *gaut* in Gaya, and *गौत-हा* *gautha* in Patna. A general word for fodder is *चारा* *chāra*, or in North-East Tirhut *चारी* *chārī*. *गजगौडी* *gajgauti* or (in Gaya) *गजगौडा*

* It is unlucky to touch money received from these men on an inauspicious day. Hence the proverb:—

बिप्रा टहलवा, चिक धन, जो बेटिन के बाढ़ ।

ग्रह से धन न चढे, तो करी बड़न से राढ़ ॥

Bipra tahalua, chik dhan, o betin ke bāh.

Ehu se dhan na gate, to kari baran se rāh.

—If you cannot get rid of your wealth by having a Brāhman servant, keeping possession of money received from a butcher, or from excess of daughters, you will do it by fighting with bigger men.

gajrauta are stalks and leaves of the carrot (भाजर *gājar*) given to cattle. The chopped up sugar-cane tops (गेंड़ *genr*) given to cattle as fodder are called अगेर *agehr*, &c., as described in § 1012. चाँची *chānchhi* in North-East Tirhut is a cattle-food made of spring-crops out before they are ripe and then dried. सानी *sāni* is the chaff and water on which bullocks are fed.

1145. To feed cattle is सानी पानी करब (or देब) *sāni pāni karab* (or *deb*). Another phrase current in Patna and Gaya is गौत देब *gaut deb*. A load of fodder is बोझा *bojha*, and also मोट *mot* in Patna, Gaya, and Shahabad. Chaff is भूसा *bhūsa*, with variants भूँसा *bhūnsa* (in Patna and Gaya) and हूसा *bhūssa*. The net full of chaff is जाला *jalla* or जाला *jāla* generally. In Shahabad and South Munger it is जलखर *jalkhar*, in South-West Shahabad जोरा *jora*, and in Patna कपाड़ *kapāi*. The refuse grass, &c., which cattle leave behind is लथेर *lather* to the west, निघास *nighās* to the north-east, and गोघार in Patna, Gaya, and the south-east. Local names are खधेल *khadhel* in Shahabad and गोरघारो *gorthāro* in South Bhagalpur.

1146. A beast that eats little is निखोराध *nikhordh* or निखुराध *nikhurāh*, also चिकनिया *chikaniya* or अल्पजिया *alpajiya* in South-East Tirhut and गवतघोर *gawatchor* in South-West Tirhut. In Patna and Gaya it is optionally नक्षोंध *naksondh*, in South Munger चिकनकौर *chikankaur*, and in South Bhagalpur चिकनजिबो *chikanjibho*.

CHAPTER XVIII.—PASTURAGE.

1147. Lands set apart for pasture are generally simply पग्गी *partī*. Special names are, however, रखात *rakhāt* north of the Ganges and रखांत *rakhānt* (South Munger). Other names are चिरागाध *chirāgāh* in Saran, Patna, and South Munger, चरांत *charānt* or बाध *bādh* in Gaya, and अरार *arār* Shahabad. A cattle-yard is बथान *bathān* or बथानी *bathāni*. The field in which cows are fed is in South-West Shahabad चराड़ *charāi*, in the rest of that district उबेर *uber*, and in South Munger उबेरा *ubera*. In Gaya it is बाध *bādh*, in Patna बहारसी *baharsi*, and in South Bhagalpur बहियार *bahiyār* or आर *ār*. Cattle left to graze without watch are अनेरिया *aneriya* to the west, अनेरा *anera* in West Tirhut, छुठ्ठा *chhutha* in Gaya, उदङ्गर *udangar* in Patna, उज्जा *ujjha* in South Munger, and उजरा *ujra* in South Bhagalpur.

CHAPTER XIX.—FENCES.

1148. A fence to keep cattle out of fields is चेरान *gherān* or चेरानी *gherāni* to the north-west. In Tirhut it is बारी *bāri* or बेड़ *berh*. South of the Ganges it is घोराण *ghorān*. Local names are चेर *ghera* in Tirhut and चापा *chhāpa* in South Munger. In Champaran हिरांत *hirānt* is a hedge of brambles not fixed in the ground.

CHAPTER XX.—GRAZING-FEES.

1149. These are of two kinds:—

- (1) Those paid to the owner of the land.
- (2) Those paid to the herdsman.

1150. A cowherd is called गार *gār*, गोषार *goār*, अहीर *ahīr*, चरगाच *charwāch* or चरगाचा *charwācha*, and मोरगडिया *gorkhiya*. A tender of cows is in North-East Tirhut गैवाच *gaiwāch*. A shepherd is गारेरी *gareṛi* or भेंड़िहार *bheṛihār*. South of the Ganges the latter also takes the form भेंड़िहार *bheṛihār* or भेंड़िहारा *bheṛihāra*. A local name is भेंड़धुरै *bheṛdhurai* in South Bhagalpur.

1151. (1) The fees paid to the owner of the land are known as खरचारी *kharchari* or खरचारी *kharcharāi* north of the Ganges and in Gaya. The latter also is used in Gaya. In Shahabad the term is बरन्दिदा *bardiya*. In Tirhut, Patna, and the east are noted काच चरार *kāch charāi*, देना *dena*, भैंसोंचा *bhainsondha*, and बरन्दावा *bardāna*. In the south-east the word is देना *daina*. In many places these fees are only paid for buffaloes, and not for other cattle.

1152. (2) Those paid to the herdsman are चरगाची *charwāchi* or चरार *charāi*. See also § 1205.

CHAPTER XXI.—COWHOUSES AND ENCLOSURES FOR CATTLE, CATTLE-OWNERS, &c.

1153. A cowhouse is गौषार *gausār* or गौषाला *gausāla*. To the east it is गोहाल *gohāl*. Local names are गेघरा *gaighara* in North-East Tirhut, दरखोल *darkhol* in South-West Shahabad, and दोगाच *dogāch* in Patna and Gaya. सार *sār* is also used to the west. बरघरा *barghara*, or in Gaya बहर्घरा *baharghara*, is a cattle-shed. In

Champaran a breeding-shed for cattle is called गारी *ghāri*. A place where cattle are collected is बचान *bathān*. In some places a special word is used for spots where buffaloes are collected, viz. हिरात *hirāt* in the north-west, लैरु *leṛk* in North-West Tirhut, बैठार *baiṭhār* in East Tirhut. To collect cattle is बचविषाणु *bathaiyāēl*. In North-West Tirhut it is लैरुविषाणु *leṛkiyāēl*. A cattle enclosure is पाखा *pājha* in the north-west and पखानी *palāni* in Tirhut. In Shahabad it is अरार *arār*. A local name in North-East Tirhut is डहा *dhattha*, which becomes डह *dhāth* in West Tirhut. A general word is बचान *bathān*. In Patna अरान *arān*, and in Gaya अरा *ara*, is an enclosure for cattle in the forest.

1154. To the west an owner of cattle is called मौषार *mauār*. The song sung by cowherds while herding is called बिरहा *birha*, or (in South Munger) महरार *mahrāi*. Another similar song, but sung to a different air, is चाँचर *chānchar*. लोरका *lorkāi* is a special cowherd's song concerning a hero called लोरिका *lorika*. In South Bhagalpur the cowherd's dance is called लोरिकारो *loriyāro*. The man who dances is called नटुवा *natua* or नेटुवा *netua*.

1155. In Gaya चेलुवा *chelwa*, in West Tirhut चाला *chalha*, and in Saran चाहा *chālha*, is a knife used by milkmen. The brand for branding cattle is सती *sāti*.

CHAPTER XXII.—CATTLE-DEALERS.

1156. These are फेरहा *pherha* north of the Ganges, and in South Bhagalpur फेरबाक *pherbaik*. In South-West Shahabad they are हरिहा *hariha*, in Patna लैरुविषाणु *leṛhiwāla*, in South Munger गैरुविषाणु *genhriwāla*, and elsewhere हारुवाला *hārwāla*.

CHAPTER XXIII.—MILK AND ITS PREPARATIONS.

1157. Milk is दूध *dūdh*. Cow's milk is गब *gabya* or गोरस *goras*. To milk an animal is दूधब *dūhab* or लगाण *lagāēb*. A cow that gives milk is लगुवर *laghar* or लगवान *lagwān*, as opposed to नगा *nātha* or नगाठा *anātha*, which is one that does not; one that milks plentifully is दुधारि *dudhāri*.*

* Cf. § 1117. Another proverb is दुधारि गायके दू कातो मजा *dudhāri gāy ke dū kāto bhala*,—even two kicks from a good milker are to be valued.

1158. When the milk of a cow or buffalo runs dry, the word used is *बिसुखब bisukhab*. Local words are *डाँठ चोपव thānth hoēb* (South-East Tirhut), *बिसुखब bisukhab* in Patna and South-East Tirhut, *चुखडाव chuhtāb* in Shahabad, and *डमरा thamra* in the south-west of that district. The milk of a cow for six months after calving is *धेन* (or south of the Ganges *धेन*) के दूध *dhen ke dūdh*. After that it is *बकेन के दूध baken ke dūdh*.

1159. The unsophisticated Bihār villager is not ignorant of the advantage which accrues to the seller by watering the milk he sells. According to popular belief the cow acts as the milkman's confederate in this, as in the proverb *गाय गोदरे मित्राव, डेऊँ पावि दुवाव, gāy goḍarē milāp, thehuneñ pāni duhāb*—the cow and the milkman are confederates, for (without the pail leaving his) knee, she lets him milk water into it. At the same time it is but fair to add that some translate the proverb as meaning that when a cow and the milkman are friends she will let him milk her even standing in water up to her knees. Both translations are possible.

1160. Clarified butter is *घू ghyu*. Sometimes the Hindi word *घी ghi* is used. The word is sometimes spelt *घीव ghīw*. Local names are *नेनुन neun* in West Tirhut, *चिकना chikna* in Gaya, *नैनु nainu* or *लेन lain* in Shahabad, and *नेनु nenu* in the east. Fresh clarified butter is *गिरा के घू ahir ke ghyu*, or in South Bhagalpur *गिरा घू girastu ghyu*; and that stored for a time in leather vessels *कूपी के घू kuppi ke ghyu* or *गेल्हा के घू gelha ke ghyu*. South of the Ganges it is also called *दखिनावा घू dakhināva ghyu*.

1161. The sediment which settles in making clarified butter is *मठियार mathiyar*, *माठ māth*, or *माठा mātha* north of the Ganges. South of it it is *लेनु lainu* in South-West Shahabad, *मठगर mathgar* in the rest of that district, *मठावा mathāva* in Gaya, and *मठाही mathāhi* in Patna. The refuse left in boiling it down is *दाही dāhi*; also *महिवा mahiwa* in North-West Tirhut, and *घोर ghor* in Tirhut generally. Other names are *फाड़न phāran* and *महरान mahran* in Shahabad, and *कोरौनी korāuni*, used in the same place and in South Munger; *खंकोड़ी khankhori* in the rest of Shahabad, and *खरचनी khurchani* in Patna.

1162. Tyre or curdled milk is *दही* or *दधि dahi*. It should be noted that this word is feminine, though grammarians say it is

masouline.* Another name current in West Tirhut is सजुर *saju*. The old curds put in to curdle milk are जोरन *joran*. Tyre is a luxury, hence the proverb घर दही, बजारो दही *ghar dahi, bahro dahi*,—only he who eats tyre at home gets it abroad.

1163. *Curdled milk* is जमान दही *jamāo dahi* or सजाव दही *sajdo dahi*. Other names are सँची *sanchi* to the east, सज्जा *sajwa* in North-East Tirhut, मिथुर *mithur* in South-East Tirhut, and जमुइ *jamui* in Gaya. The cream of this is called चाही *chhalhi*, a local variant being चाही *chali* in Patna. In South-West Shahabad it is सारी *sāri*. When this is taken off, the remainder is called कट्टर दही *katui dahi* or चककट्टर *chhalkatui*. In Shahabad it is also called मिथुर *chhinui*, and another name north of the Ganges is मिथुरी *chhinuhi*. Another variety of curds, from which the whey has been expressed or boiled, is called बेना *chhena*. It is something like the dry curds from which cheese is made in England.

1164. The thick milk given by a cow just after calving, or *beesting milk*, is फेहुस *phenus* or फेहुसा *phenusa* to the west. In Tirhut and the south-east it is खिरसा *khirsa*, and in Gaya धाकर *dhakar* means the milk of the first milking after calving, फेहुस *phenus* being that of the second. A cow that drops her milk is कामधेनुवा *kāmdhenua* or फेहुवागर *dhenudgar* north of the Ganges, also कासर *khāsar* in East Tirhut. To allow the calf to suck the teats of a cow for an instant before milking, so as to induce the latter to let the milk flow, is फेनुवाप्रस *phenhāel* or पेनुवाप्रस *penhāel*.

1165. *Cream* is मलार *malāi* or बलार *balāi*, and skim-milk पसावन *pasāwan* or (in East Tirhut) चहुवा दूध *chhanua dūdh*.

1166. *Butter* before clarification is नेन *neün* north of the Ganges, and also नेन *nen* in North-East Tirhut. South of the Ganges it is लेनु *lainu* to the west, चिकना *chikna* and मक्खन *makkhan* in Patna and Gaya, and नेनु *nenu* there and in the south-east. Butter-milk is मट्टा *mattha*, माठा *mātha*, or घोर *ghor*. In Gaya and the south-west it is also चाँह *chhānchh*. A well-known proverb about butter-milk is दूधक जरेँ मट्टा फुकि पीवे *dūdhak jareñ mattha phūki pibe*,—through having been scalded by (hot) milk, he blows on the butter-milk before he drinks it, i.e., a burnt child dreads the fire.

1167. खोवा *khoā* is milk boiled down till it is thick.

* E.g., in Manbodh's *Haribans*, VII, 48, एकचो दहि नहिँ बर पाववादि, *ekao dahi nahiñ tel adhalāhi*,—they did not take a single bad curd.

CHAPTER XXIV.—CATTLE DISEASES.

1168. Medicines are administered through a bamboo tube called *धरका dharka* or *काँड़ी kanri*.

1169. The identification of the following diseases is in many cases very doubtful. The list is given rather in the hope that it may form the basis of a future identification by competent experts. Probably many of the names given as representing different diseases are merely different local names of one and the same disease.

1170. *Farcy*.—This is *अगिया agiya* or *अगिबन्दाव aginbāv*.

1171. *Diseases of the stomach*.—*जोंकी jonki* is inflammation caused by small leeches in the stomach and liver. In West Tirhut it is *जोकन्डी jokti*. *पेटखली petchali*, or (in Tirhut) *पेटौक petauk*, is diarrhoea; *पोख pokab*, or in North Tirhut *चौड़ी chhinri*, is purging. *पिल्ली pilhi* is said to be a swelling of the liver. Perhaps it is disease of the spleen.

1172. *Foot and mouth disease*.—This is *खोरखा khorha* in the north-west and in West Tirhut, *अहवाह ahwāh* also in Champaran and North-West Tirhut, *खंगहा khangāha* in East Tirhut, *खोंगहा khongha* in West Tirhut, *भजहा bhajha* in South-East Tirhut, *अभा abha* in Tirhut generally, and (optionally) *खुरहा khurha* in Patna and Gaya.

1173. *Diseases of the throat and mouth*.—*आँती बढ़ anti barhab*, or *आँती बढ़ जापव anti charh jāeb*, is swelling of the uvula. *कंधार kanthār* (Gaya and the north-west), *भिरुकी bhirukhi* (Tirhut), *कंधा रोग kanthā rog* (Gaya and Tirhut), *धरका dharka* (Patna), is a disease of the throat and chest, which swell and prevent the animal swallowing. *धाँसी dhānsi* (north of the Ganges) is cough. *बेंगा benga* is inflammation of the vessels of the tongue followed by dysentery. *थुकहा thukha* (Patna and the south-east) is described as a disease in which saliva flows from the mouth. *सुकन्नामी sukhbhāmi* (north-west and Gaya), *चेंद्री chhēri* (Tirhut), *दंतनर dantnar* (South-East Tirhut), *हनुवा hanua* (South-East Tirhut and Patna), *सुकरवाँत sukarwānt* (Patna, Gaya, and Shahabad), *दंत लहर dant lahar* (South Bhagalpur), are described as diseases of the tongue. *जिबो jibbi* (West Bihar) or *जिबसत्ता jibhsatta* is lampus. *सुन्दी bhundi* (Patna) is described as a throat disease. *कंधा सारु kanthā sārū* (South-East Bihar), or in Gaya *नादी कान्वा nādi kanwa*, is a disease in which sores form in the throat; so also in the same tract is *जीवा*

बोला *sona hola*. चोर मटका *chor matka* (South-East Bihar) is a disease of the mouth which prevents the animal eating. मुँह-पसिया *muñhpasija* is diarrhoea with watering at the mouth. In Gaya घरघरना *ghargharwa* is a disease accompanied by rattling in the throat. घोंगड़लना *ghonghphulua* in Gaya, and गेघुवा *gheghua* in Gaya and Shahabad, is a kind of goitre.

1174. *Diseases of the feet*.—Foot-rot is जलकवाह *jhanakwah* (North-West Bihar and Shahabad) and जलक *jhanak* in Tirhut. In Patna it is जलकवाता *jhanakbāta*, and in South-West Shahabad जलका *jhanka*. बाता *bāta* is a swelling of the knee-joint. When a bullock becomes lame through overloading, the phrase used is भर जाग्रव *bhar jāëb*, सरक जाग्रव *sarak jāëb*, or उखर जाग्रव *ukhar jāëb*, or in South-East Tirhut खजा *khanja*. चरैया *charaiya* in the south-east is too large hoofs. खँग *khāng* is an insect bred in the feet, which is supposed to devour the whole body. An animal affected with it is खँगल *khāngal*.

1175. *Rinderpest*.—This is चेचक *chechak* everywhere. Other names are गोटी के निकसारी *goti ke niksāri* and महमाया *mahmāya*, both generally, and बरका बेसारी *barka bemāri* in Champaran, गोसाउन *gosāün* in North-East Tirhut, अन्तर कटवा *antar katwa* and जगदमा *jagdamma* in Gaya.

1176. *Windy colic*.—This is फुलवात *phulbāt*, पेटफुली *pet phulli* in Tirhut and Shahabad. In Patna it is बिन्हा *bindha*. A similar disease, accompanied by difficulty of breathing, is फुलबगवा *phulbagha* in Gaya and Shahabad.

1177. *Staggers*.—These are मिरगी *mirgi* generally; other names are घुरगी *ghurni* (Patna and the south-east), घुमरी *ghumri* in South-West Shahabad, and हतेवरवा *hateyarwa* in the rest of that district. Perhaps तुन्की *tunki* in the South-East, which is described as a sudden death of cattle, is a variety of staggers.

1178. *Worm (or filaria) in the eye*.—This is चँदनी *chāndni* in Gaya, and मारा *māra* or मारा फुली *māra phulli* in Shahabad.

1179. *Tumours*.—These are जहरनाह *jaharbād*, with a variant जहरवात *jaharbāt* in Gaya and South-West Shahabad. Another name in Shahabad is पिरकी *pirki*.

1180. *Fevers*.—अरैया *arhaiya* or अरैया *arheya* is a fever lasting two and a half days. In Tirhut it is called जरखोर *jarkhor*.

1181. *Pneumonia* (?).—A disease attended with panting is called हॉफ *hāmph* in the north-west and in West Tirhut. In South-East Tirhut it is हफनी *haphni*, and in North-East Tirhut बत *bat*.

1182. कोंकपका *konrpakka* (South Bhagalpur) is a disease in which the liver gets abscesses. खर्रा *kharra* is a kind of mange. It generally attacks young cattle.

CHAPTER XXV.—CATTLE-FODDER.

1183. The following grasses and other plants are used for cattle-fodder. Their botanical names have not been in the majority of cases identified :—

अंकटा *ankta*,—see अंकरी *ankri*.

अंकरी or अंकड़ी *ankri* (west), भेखरी *bhekhri* (north-west and Gaya), भिलोर *bhilor* (north-west), अंकटा *ankta* (Patna, Gaya, and south-east) ; also अटका *atka* (South Bhagalpur), *viciu sativa*.

अटका *atka*,—see अंकरी *ankri*.

अंहुली *anthuli* (Gaya), अंठिल *anthil* (South-West Shahabad and Gaya).

अनजाज *anjān*, (Patna, Gaya, and Shahabad).

अमता *amta* (West Tirhut).

अमरोरा *amrora* (East Tirhut, Gaya, and Champāran.)

अरैया *araiya* (generally).

अंठिल *anthil*,—see अंहुली *anthuli*.

अमता चिरचिरी *unta chirchiri* (East Tirhut and Gaya).

ओरी टोनी *ori tini* (Patna and Gaya).

अंकर *aunkar* (Shahabad and Gaya).

अकजा *kajla* (Champāran and North-East Tirhut) or अकरी *kayri* (Shahabad).

अकटा *katra* (Sāran and Tirhut).

अकवा *kanwa*, अका *kanna*,—see केना *kena*.

अकनी *karmi*,—see अकरी *karem*.

अकर *karār* (Shahabad and South Munger).

करम *karem* (South-West Shahabad), करमी *karmi* or करमी लत *karmi lat* elsewhere, a creeping-plant with a small white flower which grows in marshes (*Convolvulus repens*).

काना *kāna*,—see केना *kena*.

कुकरौंदा *kukraundha* (north).

कुकुसा *kukusa* (South-West Shahabad).

केना *kena* (west and Gaya) or काना *kāna* (Tirhut, Patna, and South Munger), also कान्वा *kanwa* (Gaya) and कन्ना *kanna* (South Bhagalpur and Gaya), which grows in Indian corn.

कोदिया *korhila* (Champāran and North Tirhut).

कोचारा *kauāra* (East Tirhut).

खग्गा *khagra* (Shahabad).

खुखसा *khukhsa* (general).

खोभी *khobhi*, (South-East Tirhut, Gaya, and Champāran).

गन्गी *garni* (north-west).

गँदर *ganrhar* (Shahabad, Gaya, and South Munger), गड़ियार *gariyār* (west), गँदर *ganrer* (Gaya), गँदर *gānrar* (Patna), गदर *garār* (south-east), गदरुवसा *garharua* or गँदरी *ganreri* (north).

गदरुवसा *garharua*, गदर *garār*, गड़ियार *gariyār*, गँदर *ganrer*, गँदरी *ganreri*,—see गँदर *ganrhar*.

गदपँदोसा *gadpanroa*, गदपिड़ोसा *gadpirora*, गदपुरना *gadpurna*,—see गदपुरना *gadhpurna*.

गदपुरना *gadhpurna* (West Tirhut and Champāran), गदपुरना *gadpurna* (Shahabad), गदपँदोसा *gadpanroa* (Patna and Gaya), गदपिड़ोसा *gadpirora* (South Munger), पुरनवो *purnwo* (South Bhagalpur) (*Boerhaavia procumbens*).

गँदर *gānrar*,—see गँदर *ganrhar*.

गुजेरा *gunjera* (South-West Shahabad).

गोधना *godhna* (East Tirhut).

चकोड़ा *chakora*,—see तिनपतिवा *tinpatiya*.

चरो *chari*,—see चोरँट *chorānt*.

चारा *chāra*, branches of trees, especially of the *pipar* (*ficus religiosa*) or of the *bar* (*ficus Indica*) given as fodder to elephants.

चिकनी *chikni* (South-West Shahabad and Gaya).

चिचोर *chichhor*,—see चिचोरी *chichori*.

चिचोरी *chichori* (Tirhut), also चिचोर *chichor* (north and Gaya), चिचणोर *chichhor* (east) or चिचोरो *chichoro* (South Bhagalpur and Tirhut) and लेंदरी *lenraï* (north-west).

चिनवा *chinua* (East Tirhut).

चेंच *chench* (west), गढ़ीची *garaunchhi* (Champāran and Patna), सरौंची *saraunchi* (Gaya and South Bhagalpur), सरहन्ची *sarhanchi* (Gaya and South Munger) (various species of *Achyranthus*).

चोरंट *chorānt* (Gaya and South-West Shahabad), चरी *chari* (west generally), चोरंटा *chorānta* (Patna), चङ्गुङ्गो *jurguro* South Bhagalpur), and जगन्दा *jugra* (South Munger).

जकेरार *jakerāi*,—see जौकेरार *jaukerāi*.

जिनवा *jinwān* (west) or जीरो *jhiro* (East Tirhut).

जूर *jūr* (South-West Shahabad).

जगन्दा *jugra*, चङ्गुङ्गो *jurguro*,—see चोरंट *chorānt*.

जोष *job* (Tirhut, Gaya, and west generally).

जौ केरार *jau kerāi* (generally); जकेरार *jakerāi* (south-east).
See § 959.

जहवा *jharua*,—see जार *jhār*.

जार *jhār* (Tirhut and Gaya), जहवा *jharua* (Sāran and Patna), a kind of brushwood growing on wells, &c.

जीरो *jhiro*,—see जिनवा *jinwān*.

ठदिवा *tharhiya* (Shahabad and East Tirhut).

दांगर *dāngar* (Patna and Champāran), a species of Indian corn which bears no cobs.

दाभी *dābhi* (north of Ganges, Gaya, and Shahabad).

देहुवा *derhua* (South Tirhut).

तितन्ही *tilli* (Gaya and west); तेतारी *tetāri* (Tirhut), तेतार *tetār* (East Tirhut).

तितोर *titoi* (Gaya and South Munger).

तिनपतिवा *tinpatiya* (south and west) and चकोड़ा *chakora* (Gaya south-east).

तेतार *tetār*, तेतारी *tetāri*,—see तितन्ही *tilli*.

दुधिवा *dudhiya*, a kind of wort. It is very poisonous.

दूब *dūb* or दूभ *dūbh*, also south of the Ganges दुभी *dubhi* (*cynodon dactylon*).

धक्रा *dhakra* (Tirhut and Champāran).

धिमोर *dhimoi* (Gaya and west), धिमोर *chhimoi* (South Munger).

नरचा *narcha* (Gaya).

नरजोंक *narjonk*,—see नरची *larhi*.

नरचा *narua*,—see पोचार *poār*.

नरै *narai*, नार *nār*, नैवारी *newāri*,—see लार *lār*.

पतनहार *patlār* (Champāran).

पपरा *papra*,—see धिपरा *pipra*.

पसीता *pasaunta*,—see बसीता *basaunta*.

धिपरा *pipra* (South-East Tirhut, Patna, Gaya, and South Munger),
पपरा *papra* (South-West Shahabad), and पुपरा *pupra* (Champāran
and South Bhagalpur).

पुपरा *pupra*,—see धिपरा *pipra*.

पुरननो *purnoo*,—see गधपुरना *gadhpurna*.

पोचार *poār* (south), पोरा *pora* (West Tirhut), नरचा *narua* (South
Bhagalpur), straw which has been trampled in the threshing-floor.

फरका *pharka* (South-East Tirhut).

फुटिया *phutiya* (East Tirhut).

फुलेना *phulena* (north-west), शान तुलसी *shām tulsi* (West Tirhut)
or बन तुलसी *ban tulsi* (East Tirhut).

फेफना *phephna* (East and South Tirhut).

बन तुलसी *ban tulsi*,—see फुलेना *phulena*.

बन पोखा *ban posta* (Champāran and Gaya), wild poppy.

बन केरार *ban kerāi* (Patna, Gaya, and West).

बसीता *basaunta* (north of the Ganges), बसवन्ता *baswanta* (Shahabad),
or (North-East Tirhut) पसीता *pasaunta*, which grows in Indian corn.

बिसाही *bisārhi* (East Tirhut).

बेदियाँ *berhiyān*,—see बेरी *beri*.

बेहवन *behwan*, बेहोन्हा *belonha*, बेहौधन *belaudhan*,—see बेहौधा
belauṅdha.

बेहौधा *belauṅdha*, which grows in rice and millet, found north of
the Ganges, in Patna, and South Munger. In Gaya it is बेहौधन
belaudhan, in Shahabad बेहवन *behwan*, and in Gaya and South Bhagal-
pur बेहोन्हा *belonha*.

बेरी *beri* (Gaya), बेरियाँ *berhiyān* (Patna).

बिहोर *bhilor*,—see बँकरी *ankri*.

भूसी *bhūsi* (north) or भोसा *bhosa* (Tirhut), chaff.

भेकरी *bhekhri*,—see बँकरी *ankri*.

भोसा *motha* (north of Ganges, Shahabad, Gaya, and south-east) (*cyperus rotunda*).

मकई के दँड *makāi ke dānt* (Gaya), Indian corn stalks.

मकड़ा *makra*, a grain (north of Ganges, South-West Shahabad, and South Munger) which grows in Indian corn. See § 993.

मकू के नारा *mandu ke nāra*,—see मकूचाटी *maruāti*.

मसी *masi* (Saran).

मुटमुर *mutmur* (north of the Ganges), which grows in rice-fields.

मकूचाटी *maruāti* (Gaya and South-West Shahabad), मकू के नारा *mandu ke nāra* (Gaya), *marua* straw.

मुनगा *munga*, सहजजन *sahjan*, &c., (*hyperanthera moringa*), see चसैज *saiyan* in § 1074. It is very plentiful at Gaya, hence the proverb—

मुनगा, मच्छर, मोहन्तार, माहज्जाही, ई चौरा सँ साहबगंज की चावारी,

Munga, machchhar, mokhtār, mājhādi, i chāro señ Sāhabganj ki āvādi.

—*Munga*, mosquitoes, attorneys, and courtezans, these four make up the population of Sahabganj (*i.e.*, outer Gaya).

मुनमुन *munmun* (north-west).

मुरका *murka* (north), found in wheat and barley.

मुरेना *murena* (west).

रातनी *ratni* (East Tirhut).

रातन *rātan*,—see राही *rāhi*.

राही *rāri* (north of Ganges).

राही *rāhi* (Shahabad, Patna, and Gaya, and South Munger), रातन *rātan* (South Bhagalpur).

लपटा *lapta* (Gaya and west.)

लरजोंका *larjonka*,—see लरही *larhi*.

लरही *larhi* (Patna), लरजोंक *narjonk* (South Munger), लरजोंका *larjonka* (South Bhagalpur).

लार *lār* or नार *nār*, also नरै *narai* (South-West Shahabad), and नवारी *newāri* (Patna and Gaya), untrampled straw.

लंकरै *lenrai* (Gaya and west) or (North Tirhut) कोरिहा *korhila*, found in rice-fields. The same as चिचोरी *chichori*.

शाम तुलसी *sham tulsī*,—see फुलेना *phulena*.

सर्हि *sāhi* (Gaya and Shahabad) or सामी *sami* (North-East Tirhut).

सामी *sama* (Tirhut),—see § 989.

सामी *sami*,—see सर्हि *sāhi*.

सक्वाँ *sākwañ*, (Gaya, South-West Shahabad, and South Munger).

सिहोर *sihor* or सिहोड़ा *sihora* (Champāran and Tirhut).

सुबरा *suara*,—see सुरबरीया *surbariya*.

सुरबरीया *surbariya* (Patna and Gaya), सुरबार *surbār* (Gaya and Shahabad), सुबरा *suara* (Gaya and Shahabad), सुरबारी *surwāri* (north), found in millet.

सुरबार *surbār*, सुरबारी *surwāri*,—see सुरबरीया *surbariya*.

सिही *serhi* (South-West Shahabad).

सड़ा *hara*,—see सड़ा *hadda*.

सड़ा *hadda* (north of Ganges) or (East Tirhut) सड़ा *hara*, सड़ा *hāra*, (Gaya and South-West Shahabad), which grows in millet (*euphorbia hirta*). Cf. also § 1075.

सवन्ने *hathbai* (East Tirhut).

सरातीनी *harauti* (South-East Tirhut).

सड़ा *hāra*,—see सड़ा *hadda*.

DIVISION VIII.

LABOUR ADVANCES, WAGES, AND PERQUISITES.

CHAPTER I.—PAY AND ADVANCES TO LABOURERS.

1184. A labourer generally is मजूर *majūr*, also in Tirhut and the south-east जन *jan*. Another very general word is बनिहार *banihār*. In East Tirhut a कमरिया *kamariya* (*i.e.*, he who wears a blanket) means a labouring man generally. In Patna, Gaya, and South Munger he is also कमिया *kamiyan*. In Tirhut चाकर *chākar* is a paid servant, as opposed to बहिया *bahiya* and चरवाह *charwāh*, which mean an unpaid servant. A day-labourer is in South-East Tirhut रोजर *rojha*; elsewhere he is मजूर *majūr* or जन *jan*, as above. A servant engaged by the year is नोकर *nokar* north of the Ganges, and also चरवाह *harwāh* (literally, a ploughman) in Tirhut. Forced labour is बेगारी *begāri*, and a forced labourer is बेगार *begār*, or in Gaya हाकिम हुकमी *hakim hukmi*. In East Tirhut जिरतिया *jiratiha* is a labourer who receives land rent-free and works for his master without remuneration in the agricultural season. In the north-west the पारीवाला *pāriwāla* sometimes works for his master and sometimes for himself. In Tirhut खवास *khawās* means a male house-servant, Hindu or Musalman. A proverb which alludes to him is चोरक संग चोर, पहरक संग खवास, *chorak sang chor, paharuk sang khawās*,—with other thieves he is a thief, but in the presence of the watchman he is simply a servant.

1185. A labourer's pay is मजूरी *majūri*, or to the east अजुरा *ajūra*. When paid in kind it is बन *ban* or बनि *bani*, also बनि *boni* in North-East Tirhut. When paid daily it is also called रोज *roj* or (in Patna, Gaya, and South Munger) रोजीना *rojīna*. In Champāran it is रोजबन्दी *rojbandhi*. Monthly wages is दरमाहा *darmāha*, also महिना *mahinna* when it is a fixed sum, and महिनावारी *mahinawāri* when it means the average income of the month. Yearly wages is सालिदाना *sāliyāna* or सालीना *sālīna*. In the north-west it is also सालीना *sālīna*, and in

North-East Tirhut बरखी *barkhi*. In Saran and North-West Tirhut मनी *mani* is an allowance of grain made to a servant in lieu of pay. In South Munger it is कोराना *korāna*.

1186. Advances of pay to labourers are फाजिल *phājil* or अग्वर *agwar* in the north-west. In East Tirhut they are जनौर *janaur*, in West Tirhut अगौरी *agauri*, and in South-East Tirhut also अगावर *agāūr*. In Shahabad they are अग्वन *agwan*, in Patna अगार *agār*, in South Munger अगौरी *agauri*, and in South Bhagalpur अग्रावर *agraur*. In Gaya they are कमिचौड़ी *kamiyauti*. हरवर *harwar* in the west, and हारौरी *harauri* in South-West Shahabad and Tirhut (or in East Tirhut optionally हारौर *haraur*), is an advance of grain or money or a piece of land given to a ploughman when he is engaged. In the south-east it is हरवाही *harvāhi*, in Patna कमिचर *kamiat*, and in Gaya कमिचौड़ी *kamiyauti*.

CHAPTER II.—ADVANCES TO TENANTS.

1187. Advances are generally तगावी *tagāvi* or करजा *karja*. The following special names are also used:—

1188. *Advances to buy food.*—These are खैदान *khaihan* to the west and in Patna and Gaya. In Tirhut they are called बनिचौडा *baniyautā*, and when in cash करजा *karja*. In Patna and Gaya they are खरिदान *kharihan*.

1189. *Advances to buy seed.*—These are बिचदान *biahan* in East Tirhut, and बीदान *bihan* in Patna and Gaya. In Shahabad they are बीया बेंगा *biya bengā* or बीया बादा *biya bād*.

1190. *Advances for purchase of cattle and sinking wells.*—These are तगावी *tagāvi* or करजा *karja* south of the Ganges. In East Tirhut अधलावा *adhlaṭṭā*, and in West Tirhut अधलप्पा *adhlapṭṭā*, is the advance made to a tenant for the purchase of cattle. The lender receives back the amount of the advance and half of the profit derived from the cattle.

1191. *Advances for marriage expenses.*—These are करजिन *karjain* in Patna.

1192. In Champaran दरिहकी *dahihakki* is a remission made by the landlord to a lessee. In South-East Tirhut similar terms are छुट्टी *chhutti* (used also in Patna and Gaya) and खतिर *khātir*. In West

Tirhut and Champaran when fallow land is given to a cultivator for a quarter rent or rentfree for the first year, the custom is called खिलनी *khilni*. So also in South-East Tirhut it is आसा चास *asa chās*, and in Shahabad खिल मारी *khil māri*. See also §§ 912 and 913.

CHAPTER III.—DUES PAID BY TENANTS.

1193. These are principally the cesses paid to the resident artisans and other non-cultivating residents in the village, who are known as पवनी *pawani*, पौनी *pauni*, or पौनिया *pauniya*. In East Tirhut they are पवनी पसारी *pawani pasāri*.

1194. The carpenter (बड़ही *barhi*) and blacksmith (लोहार *lohār*), who are generally the same person, get a fee from the member of a marriage procession who gets any work done by him: This is known as बिरिह *birih* in South Munger, and as बिबाह दानी *biyāh dāni* in South Bhagalpur. Elsewhere it is simply इनाम *inām* or बकसिस *baksis*. His remuneration for the repairs of instruments is कठा *katha* in Saran, जौरा *jaura* in Champaran, and पाल *pāl* in Tirhut. In Shahabad it is कमार *kamāi*, and so also in East Tirhut. In South-East Tirhut it is also भाँवर *bhāmvar*, and in South Munger it is कमैनी *kamaini*. When he is paid at so much paddy per plough, it is called, according to the amount, बोजा *bojha* in Saran, Patna, Gaya, and the south-east, अँटिया *antiya* or पाँजा *pānja* in Champaran, and पंजौर *panjaur* in North-East Tirhut. Another of his perquisites received at the time of sowing is called अजुर *anjur* in Shahabad and अँजुरी *anjuri* in Gaya. He receives a further remuneration for keeping the cane-mill in order. This is पचरावन *pachrāwan* or भाँवर *bhāmvar* in Shahabad, कोल्हकार *kolhkarh* in Patna, कोल्हकर *kolhkar* in South Munger, and कोल्हपचरानी *kolhpachrāni* in South Bhagalpur. In Saran he gets two rupees for each mill, and his remuneration is called खान *khān*. For repairing other implements he gets in Saran साली *sālī*, and a similar cess in Champaran and Tirhut is known as खरिहानी *kharihāni*. In South Bhagalpur भौरी *bhauri* is the general term used for his perquisites. In North-West Tirhut खान *khān*, and in North-East Tirhut खान *khan* or कमार *kamāi* (which means wages for any work done), are the wages for making a new mill. The grain actually given is दाली *dālī*, and amounts to from 10 to 30 *seers*. The fee for repair is बिगहती *bighati*, and is 4 annas per bigha for नोरखान

morhan or first cuttings, and 2 annas per bigha for *खंडी khānti* or second cuttings of the cane.

1195. *The weaver's perquisite.*—This is in North-West Tirhut *बानी bāni*, and elsewhere *बाना bāna*.

1196. *The shoe-maker's (बनार *chamār*) perquisite.*—This is *बानार bhāmvar* to the west. In Gaya and Shahabad, however, it is *खरिहानी kharihāni*. It is *पाह pāl* in Champāran and Tirhut, also *कमारी kamāri* and *पंजौरा panjaura* in North-East Tirhut. In the South-East it is *पंजा pānja* or *बोजा bojha*, and in Patna and Gaya *मैंगनी māngni*. *बिचौवा biyaua* to the west and *दत्त dat* to the east is the fee given to his wife for service as a midwife.

1197. *The sweeper's (मिहतर *mihtar*) perquisite.*—This also is *खरिहानी kharihāni* or *कमारी kamāri* in Shahabad. In the south-east it is a sweeper's and not the shoe-maker's wife who officiates as midwife. A sweeper in the south-east is *हारि hāri*, and his wife is *हारिन hārin*. The fee paid her for her services is *दत्त dat* or *दत्त भोजनी dut bhojni*.

1198. *The perquisites of the village accountant (पटवारी *patwāri*)* are many and various. In Patna and Gaya if the tenant's lands are *नगदी nagdi* he gets in Patna $2\frac{1}{2}$ *seers* per bigha, and in Gaya $12\frac{1}{2}$ *seers* per plough. This is called *मैंगन māngan*, and is his recognised salary. He also gets a fee of one pice in the rupee per annum for answering a raiyat's inquiries about his rent. This is called *हुजताना hujtāna*. If the land is *बाँवली bhāoli*, he gets in the same district, in addition to the above, *नोँचा noñcha* (also in Shahabad *नोँचिया nochiya*) or "pluckings," which amount to $\frac{1}{4}$ th of a *ser* per maund. A similar fee is called *बकल balkat* in Sāran. In Shahabad a village accountant gets in the case of *नगदी nagdi* lands a perquisite of $\frac{1}{2}$ an anna in the rupee, called *तकही takahi*. In the case of *बाँवली bhāoli* rents he gets $\frac{1}{2}$ a *ser* or a *ser* per maund, the first being called *असेरी aseri*, and the second *सेरी seri* or *सेरही serhi*. In the case of a general clearance of rents he gets a present of 8 annas or a rupee, called *फरकतिदान *pharkutiya**. In Tirhut this item is called *फरकाना pharkāna* or *फरिकाणा pharikāna*. In South Munger lands are principally *नगदी nagdi*, and the village accountant is a servant of the landlord and is paid by him, and gets nothing from the tenants. His pay is as follows. In the case of *नगदी nagdi* tenures he gets a *मैंगन māngan* of 5 *seers* per bigha. When the land is *बाँवली bhāoli* he gets $2\frac{1}{2}$

sers per maund, and his pay is called दहिअक मँगन *dahiak māngan*. He also gets a फरकाना *pharkāna* of one piece per rupee in the case of a clearance of accounts. In South Bhagalpur the tenant gives the accountant a नेग *neg* of 3½ *sers* per maund. In most districts he charges a piece for every rupee for which he grants a receipt. This is called generally रसिदाना *rasidāna* or रसिदावन *rasidāwan*, also कबजाना *kabjāna* in East Tirhut. होली खेलार *holi khelāi* or फगुवाची *phagudhī*, दोषात पुजार *doṣṭ pujāi*, and दुर्गा पुजार *durga pujāi*, are cesses levied by the accountant on the three main *Kāyasth* festivals of the Hindu year. The above are the usual amounts of his fees, but many of them vary from village to village.

1199. *Perquisites of the weighman.*—See § 914.

1200. *The village watchman* (गोडेन *gorait*, कोतवाळ *kotwāl*, or (when a Government servant) चौकीदार *chaukidār*) is sometimes paid by a grant of rent-free land (जागीर *jāgir*), and hence he is called in South Munger जागीरदार *jāgir-dār*. When otherwise paid, his remuneration is called generally south of the Ganges चौकीदारी *chaukidāri*. In the north-west it is खरिहानी *kharihāni*, in North-East Tirhut गोडेनक मूथ *goraitak mūth*, and in South-East Tirhut गोडेनी *goraiti*. In Patna and Gaya he is sometimes paid in kind, and his fee is then called फसिलाना *phasilāna*, and in Gaya also नौचा *noncha*.

1201. *The perquisites of the landlord.*—In addition to his rent, the following customary cesses may be noted:—गोआम *goām* in Patna, Gaya, and South Munger, बन्धवैया *banhwaiya* in South-West Shahabad, and गोहार *gohār* generally, are personal services rendered to the landlord by the tenants *en masse*. हुकुमत *hukumat* or फरमारस *pharmāis* are occasional demands of service or produce for special purposes. This in South Munger is called मदत *madat*, and in South Bhagalpur बकमैती *hakmaiti*. His perquisite of milk from his tenants' cows is in South-West Shahabad दुहाव *duhāv*. Cesses paid on special occasions are generally called सलामी *salāmi*, but there are frequently special names. *E.g.*, when a tenant's daughter is married, the landlord gets a fee called बियाहदानी *biyāhdāni*, सद्दियत *sādiyāt*, सद्दियत *sādiyāt*, or सद्दियाना *sādiyāna*. In North-East Tirhut this is usually one rupee four annas at a girl's marriage, and ten annas at a boy's marriage, which is realised from every one except Brāhmans, Kāyasths, Rājputs, and Musalmāns. In South-West Shahabad it is मैरुवञ्च *maīruvanch*. In Tirhut and the east धिंगान *dhingān* is a fee paid

on the marriage of a daughter for the second time, and *bhojni* is paid on the marriage for the first time of a boy or girl. The former cess is paid in cash, but the latter in kind; e.g. in rice, pulse, or clarified butter. For other cesses paid by cowherds, see § 1151. The help given by the tenant in ploughing the landlord's lands is *हरी hari* to the north and the west generally. To the east it is *हरिहर harihar*, *हरिहरा harihara*, and *हरिहरी harihari*. Local names are *संगहा sangaha* in North-East Tirhut, *हरार harāi* in Shahabad and South-West Tirhut, and *हराही harāhi* in Patna and Gaya. The presents given to the landlord when he visits the village are *सलामी salāmi* or (in Shahabad) *नजराना najrana*. His fee when a house is built or sold is *चौठ chauth* generally north of the Ganges, and also in East Tirhut *जर चौठ jar chauth*. In towns in Patna and South Munger it is *चौथैया chauthaiya*, and elsewhere simply *सलामी salāmi*. He collects cesses in the nature of a ground-rent from the resident artisans and traders in the village. These are called *मोतारफा motarpha* or *मोतारफा motharpha* generally, *कोठियारी kothiyāri* in Champaran and Tirhut generally, and *बसुरही basurhi* in East Tirhut. South of the Ganges they are *दुवनी duanni*, or (to the east) *अबुआब abuāb*. In Patna and Gaya the former name represents a cess of the following description. 15 *mans* of grain, or thereabouts (according to village custom) is assumed (when rent is paid in kind) as the produce of one *bigha*. For each *bigha* (or 15 *mans*) thus calculated of the tenant's share of the crop, the landlord takes a cess of 2 *ānas*. In the case of lands paying cash rates, the cess is levied at from 2 *ānas* to 9 pice on each *bigha* of land held by the tenant. *पूर pūr* is a fee of one rupee per loom paid by weavers. In South Munger *चरफा charafa* is a cess paid by tanners. In North-East Tirhut *केयाली keyāli* or *कियाली kiyāli* (also *बरदाना bardāna* in Patna) is (or was) a transit-duty levied on cartmen for every load of grain they took. Sometimes it was levied at every place where they halted for the night. In the same tract the same name is also used for a tax levied on grain-sellers' weights. This last is called *कौड़ी kauri* in the north-west, and *मलिकार चुटकी malikāi chutki* in South-East Tirhut. In Shahabad it is *बाय़ा bayāi*. In Gaya it is *किराया kirāya*, and the corn paid is *मॉंगनी māngni*. In the south-east *तहबजारी tahabjāri* or *तबजारी tabjāri* is a similar tax levied on shopkeepers.

1202. Rents are generally calculated in the old *sicca* rupees of Akbar, which are converted into current coin by adding exchange rates,

called बहा मास *batta māl* and बहा कम्पनी *batta kampani*. The *batta māl* is added direct to the rent in *sicca* rupees, and denotes the exchange rate between them and the Murshidabadi coin introduced in the year 1773. In 1835 the introduction of the Company's rupee, $1\frac{1}{2}$ of which equalled $\frac{1}{2}$ of the Murshidabadi rupee, led to the imposition of a further rate of exchange, called *batta kampani*, which is calculated on and added to the rent calculated in *sicca* rupees plus the *batta māl*. Each of these rates of exchange is generally less than one anna per rupee.

1203. *Dues given for religious purposes.*—The first fruits given to Brahmins are बिहुन पिरित *bisun pirit*, and also (north of the Ganges) बिहुन बन्ध *bisun ans*. To the west they are अंगौंके *angāñkē* or अंगौंवाँ *angāñvāñ*. On the other hand first fruits set apart for house-gods (भूमि गनेस *bhūmi ganes*) or penates are अगौं *agaun*, or (in Shahabad) अगन्वर *agbar*, and (in Champaran) रसुवर *rasuar*. In South Munger three small heaps (कुद्दी *kuddi*) are put aside on the threshing-floor. One is given to the Brahmins, and is called बिहुन पिरित *bisun pirit*; the second is given to the मुखर *mushar* of the village, who is known as देहुरी *dehuri*, and is called सहार *sahār*; and the third, called अगौं *agaun*, is set apart for the house-gods, and is consumed by the cultivator himself. In South-West Shahabad a small heap of grain is put aside for the village god (दिहवार *dihwār*). This is given to the village milkman (गोहार *goār*), who performs the worship of the god, and it is called पिहार *pithār*. In South Munger बहरैया *bahraiya*, and generally बेहरी *behri* or बहरिया *bahariya* (all of which mean simply a subscription), are names for the subscription for the expenses of village worship, and दहिबक *dahiak* is a similar cess of $1\frac{1}{2}$, and सवैया *savaiya* of $1\frac{1}{2}$, seers per maund. The grain set aside for beggars (फकीर *phakir*) are known as बिच्छा *bhichchha* or बीख *bhikh* amongst Hindus, and रसुली *rasūli* or फकिराना *phakirāna* amongst Musalmāns. The सिब बन्ध *sib ans* is the portion set aside for religious mendicants (सन्यासी *sanyāsi*).

1204. *Miscellaneous.*—पुरौंता *puraunta* is the fee paid by the members of a marriage procession to any person who does any work for them. In North-West Shahabad 10 *seers* per plough are taken each by the washerman (धोबी *dhobi*) and the blacksmith (लोहार *lohār*). This is called जौरा *jaura*. In the same place खारवन *kharwan* is an armful of crop given to each of the following:—the blacksmith, the carpenter (बरही *barhi*), the barber (नौवा *nauva*), and the washerman; and the केरा *kerā* is a smaller bundle of crop given to each of the same four.

Again पूरी *pāri* is three handfuls of crop given to the same four. In West Tirhut a similar cess is called बाह पड़ेरी *pāl paseri*.

1205. In Shahabad, and also in South Bhagalpur, बन् *ban* is an allowance of one maund in twenty-one or twenty-five of crop given to the agricultural labourer. In South-West Shahabad the cowherd receives a certain share of the milk of the cows he grazes, which is called बारा *bāra*. In South Munger this is परौबा *paraundha*, and in South Bhagalpur परोबो *parodho*. Similarly अठवारा *athwāra* (i.e. paid every eighth day) in Saran, पार *pār* in North Tirhut, भोज *bhānj* in West Tirhut, and पार *pāra* or दुधिया *duhiya* in South Tirhut, is the milk given to the milkman as a fee for milking cows. चरवाही *charwāhi* is a fee paid to the herdsman for herding. It is also चरार *charāi* in Shahabad. सलामी *salāmi* or कमरखोहार *kamar-kholāi* is the term applied to the presents made to or demanded by a police-officer or Government peon on entering a village, and the same terms are also applied to the presents made by the local police to the menial servants of magistrates and other high Government officials when in camp in their own district. In West Tirhut they are also called इनाम *inām*.

DIVISION IX.

LAND TENURES.

CHAPTER I.—TENURES.

1206. The descriptions contained in this division do not pretend to be legal definitions of the tenures referred to. On the contrary, they are only to be taken as giving the popular ideas (always more or less indefinite) current among the villagers as to the nature of the tenures.

Land tenures may be divided into—

- (1) Proprietary tenures.
- (2) Tenures intermediate between proprietary and cultivating ones.
- (3) Cultivating tenures.

CHAPTER II.—PROPRIETARY TENURES.

1207. (1) *Revenue-paying tenures*.—These are known everywhere as ज़िम्दारि *jimidāri*. A very large landlord is, however, called a तालुकादार *tālukadār*, and his tenure तालुकादारि *tālukadāri*. This is the popular distinction in Bihar between the two names. Both tenures can be held in common and can be divided. When, in popular phraseology, it is wished to name a tenure which cannot be held in severalty, but is owned by one heir, the other heirs being given villages or *parganas* on which to subsist, it is called a राज *rāj*. In a ज़िम्दारि *jimidāri* (or तालुकादारि *tālukadāri*) tenure the whole land is held and managed in common. The property itself is called ज़िम्दारि *jimidāri*, or मिल्कियत *milkiyat* if it is small, and तालुका *tāluka* if it is large. The rents with all other profits from the estate are thrown into a common stock, and after making the deductions to be noted further on the balance is divided among the proprietors according to a fixed law or share. The deductions are the Government revenue and other expenses. The Government revenue is generally मालगुजारी *mālgujāri* or मालगुजारी *malyujāri*, also लाट *lāt* and रोल् *rol* in Tirhut and to the east, and खजाना *khajāna* in North-East Tirhut. In Patna

and Gaya it is also known as कलत्रि *kalatri*. The other expenses are known as गाँव खर्च *gañ kharch* generally, also गाँव के खर्च *gānw ke kharch* or गाँवियाँ खर्च *gawaiyāñ kharch* in Tirhut. In South-West Tirhut they are also सालीना खर्च *sālina kharch*. In Gaya (and East Tirhut optionally) they are देही खर्च *dehi kharch*, in Patna एकहराज *ekhrājāt*, and in South Munger गरही खर्चा *garhi kharcha*. In South Bhagalpur they are बन्धखर्चा *banh-kharcha*, which properly means embankment expenses.

1208. A landlord is ज़िम्दार *jimidār* or मालिक *mālik*; also sometimes सरकार *sarkār*. Local names are गाँव के ठाकुर *gānw ke thākur* in South-West Shahabad, and गाँवियाँ *gawāñ* generally in that district. When the tenure is held in joint property, the shareholders are called हिस्सेदार *hissedār*, &c., see § 1214. The Government revenue is paid in by one of the body, called लामदार *lamardār* in Saran and मोक्तार *mokhtār* in Tirhut and Patna. In Shahabad he is लामदार *lambardār*. He is also known generally as तहसिलदार *tahsildār*, कारपरदाज *kārpardāj*, or मोक्तियार *mokhtiyār*. In North-East Tirhut he is also known as टिपदार *tipdār*. The inferior proprietors are known as खुरदिहा मालिक *khurdiha mālik* north of Ganges, while south of the Ganges they are खुरदिहा मालिक *khurdiya mālik*. In Patna they are known as जुजुवी हिस्सेदार *jujwi hissedār*.

1209. (2) *Free grants*.—These are known generally as बिरिठ *birit*, and the holder as बिरिठिया *biritiha* or बिरिठदार *biritdār*. These are general terms, and amongst them may be mentioned the following:—

(a) *Granted for religious purposes*.—These are known generally as संकल्प *sankalp*, and are of different varieties, such as बरमोतर *barmotar*, for the worship of Brahma; बिष्णु प्रीत *bishun prit* or बिष्णु अरपन *bishun arpan*, for the worship of Vishnu; सिवोतर *sibotar*, for the worship of Siva; किरान अरपन *kishan arpan*, for the worship of Krishna, and so on.

(b) जागीर *jāgīr*, लाकराज *lākhraj* (rentfree), माफी *māphi*, मिन्ही *minhai* (at reduced rent), or खिल्लत *khillat*. These are properly grants for warlike services. They are also (especially जागीर *jāgīr*) applied to the free grants of land for services made to the potter (कुम्हार *kumhār*), watchman (गोरौत *gorait*), and other village servants.

- (c) A grant given to the family of a man killed in the Raja's service in open fight. This is **मरुवत** *marwat* in the west, and **मरौती** *marauti* to the east.
- (d) A **बिरत** *birat* may be either acquired by purchase, when it is known as **खरिदगी** *kharidgi*, or it may be given by favour, when it is called **इनाम** *inām* or **इनामत** *ināmat*. Local names in such a case are **खैरात** *khairāt* in Shahabad, and **खुशबकत** *khusbakat* in South Bhagalpur.
- (e) **खोरिख** *khorish* or **मोकरी** *mokri* (north of the Ganges), also **पालक** *pālak* (Saran), other local names being **खोराकी** *khorāki* or **परवसती** *parvastī* (South-East Tirhut) and **खानदान** *khāndan* (North-East Tirhut). This is an assignment by a rāja to a younger son or brother of a certain number of villages in the estate for subsistence for himself and his descendants for ever. On failure of descendants the grant reverts to the parent estate. This occurs in the case of a rāj which cannot be divided.

CHAPTER III.—INTERMEDIATE TENURE.

1210. The principal intermediate tenure is that known as **ठीकेदारी** *thikedāri*, in which the holder (**ठीकेदार** *thikedār*) contracts to hold the property at a fixed rental either for a certain term of years or until a sum of money (**जर समन** *jar saman*) advanced on usufructuary mortgage is repaid. In the former case it is also called **खुशकी ठीका** *khushki thika*, and in the latter **पतातन** *patautan* in Shahabad, **पटौचाँ** *patāuñān* in the North-West and Tirhut, and generally **सडौचा** *sadhaua patāua*. A mortgage lease is **इजारा** *ijāra* or **जर पेशगी ठीका** *jar peshgi thika*. See § 1487.

1211. Among other intermediate tenures may be noticed the **पतनी** *patni* tenures, which form the subject of special laws. They may be briefly described as estates created by a landlord by separating a portion of his estate and letting it in perpetuity at a fixed rent. Subdivisions of these tenures let on the same principle are called **दरपतनी** *darpatni*, and these last are sometimes again allotted into smaller portions, called **सोपतनी** *sopatni*. The holder of *patni* lands is called a **पतनीदार** *patnidār*.

1212. A tenure which may be either intermediate or cultivating, and which may be noticed here, is मोकररी *makarari*, or tenure in perpetuity at a fixed rent. In some parts of the country these are also popularly known as सिक्की *sikmi* tenures, which usually mean under-tenures held by a cultivating raiyat.

1213. In Champaran सिक्की *sikmi* tenures are described as dependent proprietary taluks paying land revenue through the landlord who is responsible for it, and not into the Government Treasury direct. Concerning सिक्की *sikmi* rents in Gaya, see §§ 1225, 1226.

CHAPTER IV.—SHARES AND SHARERS.

1214. A share in a village is हिस्सा *hissa* and also (in Tirhut and the west) बकरा *bakhra*. The subdivision of a village held by a proprietary body is known as पट्टी *patti* or तख्ता *takhta*, also थोक *thok* north of the Ganges and फाट *phāt* in Gaya. A shareholder is हिस्सेदार *hissedār* or सरिकन्दार *sarikdār*; also बकरन्दार *bakhardār* to the west, पट्टिदार *patidār* in Tirhut. The proprietor of a half share is called अधिया *adhiya* north of the Ganges, and आधेआध *ādheādḥ* in South-West Shahabad. The inferior shareholders are called खुरदिहा *khurdiha*, &c., as described in Chapter II. पट्टी *patti* is also used to mean the principal share in a village, which may contain several सिक्की *sikmi* or subordinate shares. The shares of a brotherhood are भैयांट *bhaibānt* generally, or in Patna and South Munger भैया बंट *bhaiya bānt*. In the west they are also भैयावध *bhaiwadḥ*. A father's share is बपन्स *bapans*, also बपन्स बपन्स *baphans* in Sāran, बपौटी *bapauti* in North-East Tirhut, and जद्दी *jaddi* in West Tirhut. An elder brother's share (which according to popular belief was larger than the share of the younger brothers before the institution of the English law-courts) is जेठन्स *jethans*, also जेठन्स *jethans* in Sāran, and in North-East Tirhut जेठौती (not जेठौटी) *jethauti*. The Government revenue is मालगुजारी *mālgujāri*, &c., as described in Chapter II. The half-yearly instalment is known as अधकार *adhkhar* or अधकार *adhkar* north of the Ganges, also as अठनिया *athaniya* or अठनी *athanni* generally. In South Bhagalpur it is अधकार *adhkar* *kist*. The distribution of the revenue over the sharers in villages held by a brotherhood is in South-West Shahabad बेर *bher*. Elsewhere a periphrasis is used, such as हिस्सा पट्टिदारी *hissa patidāri*.

A proprietor by purchase is खरिदार *kharidār*, and also (north of the Ganges) बेदार *baidār*.

CHAPTER V.—CULTIVATING TENURES.

1215. A cultivator is known as असामी *asāmi*, रैयत *raiyyat*, परजा *parja*, or कास्तकार *kāstkār*. In Patna he is also पोतेदार *potedar*. A tenant with rights of occupancy is मोहुरी *maurūsi* (*literally*, hereditary) or कदोमी *kadīmī* (ancient), also देही *dehī* (resident) in Patna and Gaya, and जददी *jaddī* (ancestral) in Shahabad. A tenant at fixed rates is इस्तमरारी *istamrāri*, but this distinction is little observed. Hardly any cultivators, and very few landlords, know the difference between a tenant at fixed rates and one with a right of occupancy. A cultivator without rights of occupancy is known as गैर मोहुरी *gair maurūsi*, also as पाही *pāhi* (*literally*, 'foreign' or 'non resident') in Patna and Gaya, and खरिदगी *kharidgi* (*literally*, acquiring by purchase) in Shahabad. In North-East Tirhut he is हाल उपार्जित *hāl upārjit* (newly created). These names are interesting as showing what cultivators themselves consider to constitute a non-occupancy tenant.

1216. In Shahabad, especially along the south bank of the Ganges, there is a class of tenants called गुरुदस्तादार *gudashtādār* or गुरुदादार *gudastādār*. They are generally Rajpūts and Brahmans whose ancestors conquered the country, and who, while serving under the landlords, for whom they were always ready to fight, were considered entitled to a privileged position. A गुरुदस्ता *gudashta* or गुरुदा *gudasta* tenure is held at a rent fixed for ever,* and is alienable without the consent of the landlord. It is, in fact, a freehold subject to a rent charge. The holders seldom sublet, and are a body of peasant proprietors, very prosperous as compared with other tenants, and furnishing thousands of recruits to the army. Another similar tenure is known as गौरा *gora*. In this the rent is fixed for ever in a holding with specified boundaries, without reference to the quantity of land. The rent is not variable even if the land be found to be more or less than the quantity roughly estimated at the original settlement. It is alienable without consent of the landlord.

1217. In some estates there is a kind of head tenant, who acts as an intermediary between the proprietor and the cultivator. He collects the rents and receives in return some petty privileges and immunities. He is known generally as महतौ *mahton*, and in

* This point of fixed rents is denied by some landlords.

Patna and Gaya as महुतोबाड़ा *mahtoāra*. In Saran he is also known as टिपदार *tipdār*, in North-East Tirhut as मोकदम *mokadam*, and in South Bhagalpur महर *mañrar*. Generally, however, the head tenant is called जेठरैबत *jethraiyaṭ*, and he usually performs the above duties. The high-caste cultivators are known as असराफ *asrāph*, local names being सुरफा *surpha* in Patna, सुरफान *surphān* in Gaya, and बड़ अदमी *bar admi* north of the Ganges. In South Bhagalpur, the quarter of the village where such live is called बबुतोला *babutola*. The remission of rent for such high-class tenants is माफी *māphi* generally north of the Ganges, also छुटती *chhuti* or कसबरे *kamsare* in East Tirhut. In South-West Shahabad and Gaya and South Munger it is रेबापत *reāet*, in the rest of Shahabad मरौवती *marauati*, in Patna कमी *kami*, इनाम *indām*, or इलाम *ilām*, and in South Bhagalpur माफ *māph*. The low-caste tenants are known as राड़ जाति *rār jāti*, नीच *nich*, or चोट लोग *chhot log*. They are also known as राजील *rajil* in South-West Shahabad, कमीना *kamīna* in the rest of that district, राड़ भोड़ *rār bhor* in South Bhagalpur, सोलकान्ह *solkanh* in Tirhut, and रेवान *raiyaṅ* in Gaya. A proverb about them is—

कायस्थ किहु लेलें देलें, बरहमन खिचौलें ।

धान पान पनियालें, चौ राड़ जाति लतियालें ।

Kaeth kichhu leleñ deleñ, Barahman khiyauleñ.

Dhān pān paniyauleñ, au rār jāti latiyauleñ.

—A Kāyasth does what you want on payment, a Brāhman on being fed, paddy and betel on being watered, but a low-caste man on being kicked.

1218. Cultivators may also be divided into resident and non-resident. The resident cultivator is चपारबन्द *chhaparband*, also दिही *dihī* in North-East Tirhut, देही *dehī* in Patna and Gaya, and बारी बस्त *bāri bast* in the south-east. A non-resident cultivator is पाही कास्त *pāhī kāst* or पाही *pāhī* (foreign), a word frequently confounded with पाई *pāi* (literally, a foot; hence used to mean an under-tenant). The word पाई *pāi* has almost fallen out of use now, but it is still understood, and has led to much confusion in laws and treatises on the rent-law, rendering it possible that the rights and liabilities of the under-tenant have been transferred to the non-resident cultivator. In South Bhagalpur the non-resident cultivator is known as पैहार *paihār*. The दोहट *dohat* or दोहटा *dohṭa* cultivator differs from the पाही *pāhī* cultivator in that he keeps up two establishments and cultivates in two different villages, while the पाही *pāhī* cultivator does so only in one.

1219. Below the ordinary cultivator there is sometimes an under-tenant, who is known as सिक्मी *sikmi* or कुरथौली *kurthauli*, also as पेतावाला *petāwāla* in the north-west and कोहिएली असामी *kohiāli asāmi* in East Tirhut. It is said that to the south-east in the case of a कुरथौली *kurthauli* tenure the rent of the under-tenant is fixed at a money rate, but is paid in grain at the market rate of the grain at the time of payment. Elsewhere the rent of under-tenures is generally paid in kind.

CHAPTER VI.—RENTS.

1220. Rent is लगान *lagān*. North of the Ganges and in South-East Bihār it is also पोता *pota*, with an optional variant पोत *pot* in South-East Tirhut; another name current north of the Ganges is मलगुजारी *malgujāri*. Rent rates are दर *dar*, सरे *sare*, or सरह *sarah*; also दारबन्दी *darbandi* or सरहबन्दी *sarahbandi*. चुकौवा *chukaua* north of the Ganges is rent payable at a fixed rate.

1221. Rent paid in cash is known as माल *māl*, and that paid in kind as ऐन *ain*. When rents are paid in cash, the tenure is known as नगदी *nagdi*, and also in East Tirhut as खाप *khāp*. When paid in kind, it is known as मनखाप *mankhāp* or भाँली *bhāoli*. In मनखाप *mankhāp* or मनठीका *manthika*, हडा *hunda* or मनहडा *manhunda*, the rent is a fixed quantity of grain paid as rent, irrespective of the proportion it bears to the whole crop. This custom is current principally in Tirhut and Champāran. In Patna it is called मनी बन्दोबस्त *mani bandobast*, and a variety in which a certain number of maunds of cleaned rice per *bigha* is taken as rent is known as चौराहा *chaurāha*. These tenures are principally adopted by landlords when letting their जिरत *jirāt* or home-farm lands. In भाँली *bhāoli* a certain fixed proportion of the whole crop is taken by the landlord. This division is called बट्टा *batāi*, &c., and a full description will be found in §§ 902 and ff.

1222. A tenure which has been noted in Patna is the हस्तबूदी *hastbūdi*, derived from the Persian *hast*, 'is,' and *būd*, 'was,' and which means literally 'the-is-and-the-was tenure.' In this the rate of rent is fixed at so much per *bigha*, but rent is only charged for so much area as is actually bearing crops at the time of harvest. Thus, suppose a piece of land measuring one *bigha* is cultivated, but for some reason

(such as inundation, destruction by insects, &c.) the area of land actually under crops when ready for harvest is found to be 16 *kathas*, then the rent of four *kathas* is remitted and the rent for 16 *kathas* only is demanded. It thus closely resembles the *utbandi* tenure of Bengal. Compare § 1229.

1223. **हाल हासिली** *hal hasili* tenures also exist in Patna and Gaya. In these the cash rent is determined on the spot after inspection of the existing crops on the land. A very similar tenure is known as **बककत** *balkat*. In this the landlord's men, accompanied by the tenant, inspect the crops when ready for harvest, and fix a cash rent by estimating roughly the quantity of produce and its value.

1224. A peculiar tenure, which is principally adopted in lands which are generally subject to inundation, is known as **जेदादी** *jaidadi*. It is also adopted where the land is extremely bad and the prospect of a crop is uncertain. The principle is that the full rent agreed upon is paid on the land in any year in which any crops whatever (however small) is grown upon it. In any year in which no crop is produced upon it, no rent is paid.

1225. The tenures* and rent system in the district of Gaya are worth noting. Four-fifths of the cultivated lands are let on the **बाबली** *bhaoli* system, as has been described in sections 902 and following. In the lands held on the **नगदी** *najdi* system the rent conditions are somewhat peculiar. The *najdi* tenure is of two descriptions,—**सिकमी** *sikmi* or **शिकमी** *shikmi*, and **चिकत** *chikath* or **चकत** *chakath*.

1226. A **शिकमी** *shikmi* tenure is described by Bābū Bhūp Sen Singh as that under which the landlord has not any power of enhancement, irrespective of the period for which the tenant might have been in possession. The money-rent is not fixed upon the land, but upon the crops actually grown, varying with the nature of the soil and the class of tenants, whether high caste (**सुरफान** *surphān*) or low caste (**रैयान** *raiyan*), the former having a lower rate to pay than the latter. The lands generally under this tenure are the **दिहान** *dihāns* lands, or the best land lying on the borders of the inhabited portion of the village (see § 784), and the crop grown thereon pays a higher money rent than the same crops grown on fields

* Concerning the tenures in Gaya, I have to acknowledge my indebtedness to an admirable note prepared by Bābū Bhūp Sen Singh, Government Pleader of that district.

more distant from the village site. The same *shikmi* field also pays a rent varying with the crop. Thus if a Brahman tenant planted it with opium poppy in one year and with an ordinary spring crop next year, he would pay a higher rate of rent the first year than the second; while a low-caste tenant would have to pay for both of them a higher rent than the Brahman. Every tenant in a village has a fixed quantity of *shikmi* land partly at the higher and partly at the lower crop rate. If the tenant grows opium poppy upon a *bhaoli* and not a *shikmi* field, he pays for one harvest *bhaoli* rent, and is liable also to pay *nagdi* rent for the poppy at the rate fixed in the village for the particular class of tenants to which he belongs for poppy grown under such circumstances. According, however, to other authorities the rate of rent of these *shikmi* tenures is unalterable, but an extra rate or cess of so much per *bigha* is put on when special crops, such as opium or sugar-cane, are grown, and is taken off again when these special crops cease to be grown. Compare § 1231.

1227. The चिकठ *chikath* or चकठ *chakath* tenure is, according to Bābu Bhūp Sen Singh, a temporary settlement of waste or uncultivated but culturable lands for limited terms of years, at nominal rents, for the purpose of reclaiming them or bringing them under cultivation. This tenure is governed by the terms of the contract between the parties. If one term be not sufficient to render the lands fit for proper cultivation, the settlement is renewed from time to time till they become capable of yielding full crops. They are then settled as *bhaoli* or *shikmi* lands, according to their quality. In *chikath* lands no right of occupancy accrues by custom, and the rent is capable of enhancement on the expiry of the term of the settlement.

1228. According to Bābu Bhūp Sen Singh when a summer or जेठवा *jethua* crop is grown on *bhaoli* land, an additional rate of 20 annas per *bigha* is charged as rent, the local *bigha* equalling $2\frac{1}{2}$ Bengal *bighas*.

1229. In South-West Shahabad, when in rice lands, the tenant pays only for the land under rice, and not for any land which may be fallow, the phrase उठनी परती *uthni parti* is used. Compare § 1222.

1230. A remission of rent on account of deficient produce is माफ *māph* north of the Ganges, and also छुटनी *chhutti* in East Tirhut. South of the Ganges it is नाबूद *nābūd*, or, when made on account of inundation, गरकी *gariki*.

1231. Special crops, such as tobacco or poppy, on which special money rents are always assessed, are known as *जबन्दी jabdi* or *जपन्दी japti*. Cf. § 1226.

1232. Of the spontaneous produce of a village, *बनकर bankar* is the produce from forest land, wood, gums, &c. In Shahabad it is also called *बन चिचोली ban chhioli*. *जलकर jalkar* is the produce derived from lakes, streams, &c.; and *फलकर phalkar* is the produce of fruit. *सिकार माही sikar mahi* to the west is fishing rights.

1233. Fields situated in one village and included in the area of, and belonging to the proprietors of another village, are called *मोतकने motakne*, or (in North-East Tirhut) *तांहुका taluka*.



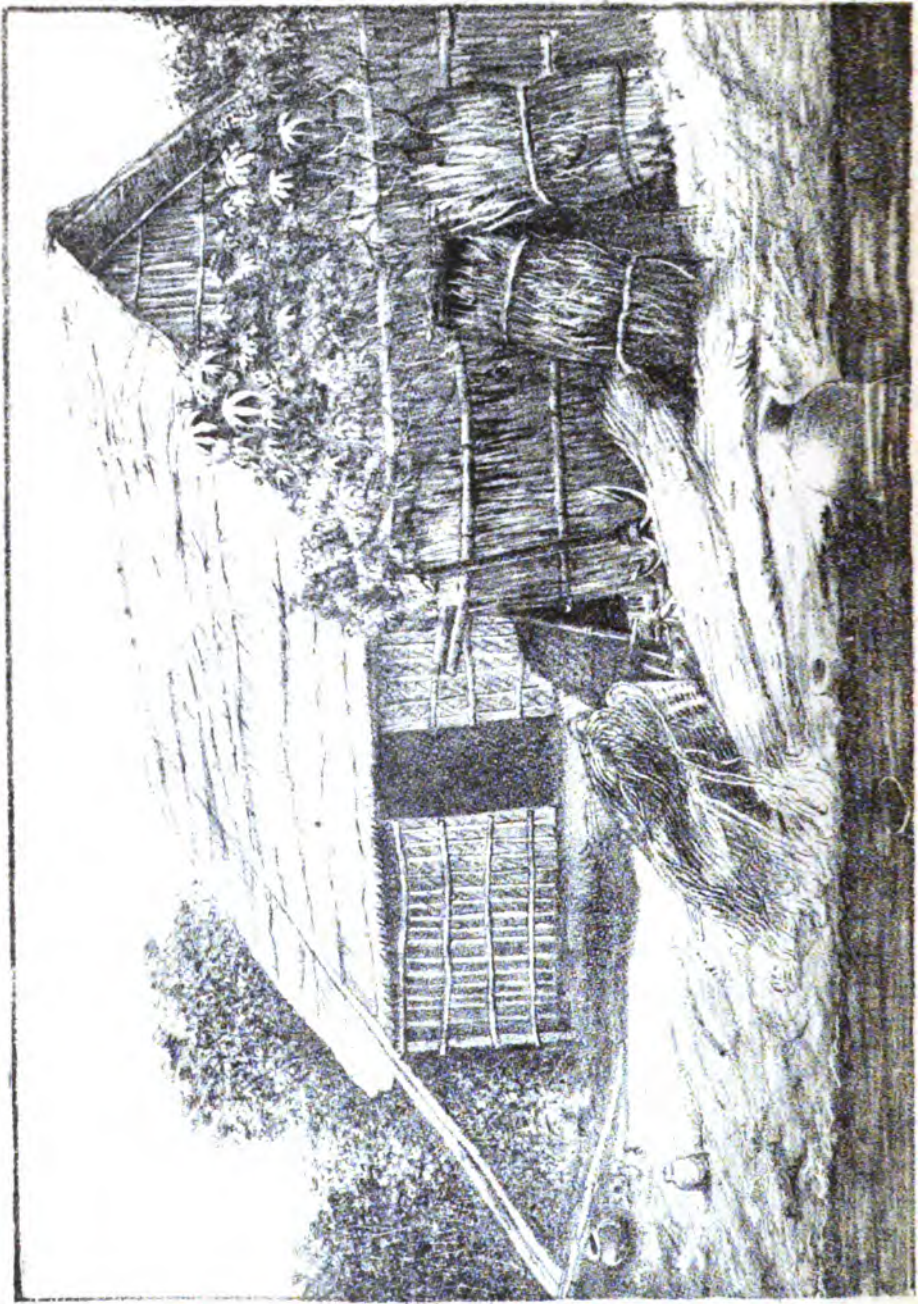

The house of a well-to-do cultivator on the banks of the Genava in Padma.

DIVISION X.

THE NATIVE HOUSE.

CHAPTER I.—THE NATIVE HOUSE.

1234. A *house* is मकान *makan* or घर *ghar*. Local variants of the latter are गिरहो *girhi* in Gaya and Saran, गौर *ghaur* in South-East Tirhut, घरा *ghara* in South Munger, and गिहो *grihi*, घरठ *ghara*, or घरो *gharo* in South Bhagalpūr. A name current in Shahabad is बखरी *bakhri*. An enclosure containing several houses is north of the Ganges हवेली *haveli* or हवेली *haveli*, and south of it हाता *hata*. South of the Ganges and in Saran हवेली *haveli* or हवेली *haveli* generally means the *female apartments*. A *palace* is धौरहार *dhaurahar* or धरहर *dharhar*, as in the proverb खतो चढ़ तर, सपनार धरहर *sati khar tar sapnāi dharhar*,—he sleeps on grass and dreams of palaces. A *hut* is खोंपड़ा *jhompṛa* or खोंपड़ी *jhompri*, खोंप *khomp*, खोंपड़ा *khompṛa*, खोंपड़ी *khompri*, or पलानी *palāni*. कुटी *kūti* or कुट्टी *kutti* is the hut of a religious mendicant (धकीर *phakir*). Other names used north of the Ganges are मठ *math* generally, and मठिया *mathiya* to the west, अस्थल *asthal* to the north-east, and जगह *jagah* or अकराहा *akhraha* to the south-east. मरै *marai*, मँदुरै *mañrai*, or मररै *marai*, is a grass hut, and मँदुरो *mānro*, &c., (see section 1307) is the hut in which a marriage ceremony is conducted. A little hovel or hut is north of the Ganges गोषिया *goṣiya*. South of the Ganges it is in Patna and Gaya मरुका *maruka* or कुरहा *kārha*, in Shahabad टाटी *tāti* or बरहाघर *barhaughar*, and in South Bhagalpur डाको *dhāko* or मोरका *morka*. सिरकी *sirki* is a hut or tent made of reeds, as in the proverb सिरकी एक देखि ताहि, ताहि बर सँ चाप्रक पावि, सिरकी उठावेक रहल ना बेरा, चाकू नाच नः पाइ पगन्हा *sirki ek delanhi tāni, tāhi ber mañ del pāni, sirki uthābaik rahal na bera, āgu nāth na pāchhu pagha*,—he pitched his hovel and it began to rain, nor could he get an opportunity for striking it; he was (like an ass) without nose-ring or tether. A ruined house or enclosure is दीह *dih* or खँदर *khānrhar*. A hut in the forest is north of the Ganges पाखा *pāṣha*,

and south of it चर चर *chanchar ghar* in Gaya, चाँचन्नावा चर *chānch-wāla ghar* in South Bhagalpur, टटगुर *tatghar* in South Munger, and मरही *marhhi* in South Bhagalpur.

1235. Straw huts used by the poor are डडौचर *tataughar* north of the Ganges, and काची पोस *kāhi pos* south of it. In Shahabad they are also called दोचररा *dochra*, and in South Bhagalpur चरो चर *kharo ghar*. They are also very generally known as फूस के चर *phūs ke ghar* over the whole Bihar tract. A masonry house is पक्का *pakka* or पोचन्ना *pokhta*. When built of stone it is called in Shahabad चाँदनी *chāndni*. When built partly of bricks and partly of mud, it is कच्चा पक्का *kachcha pakka* or कच्चा पक्का *kancha pakka*. In Shahabad it is, however, कच्चा *kancha* or काँचा *kāncha*. A house built entirely of mud is कच्चा *kachcha*; it is also to the west खाम *khām* and to the east भीत चर *bhit ghar*.

1236. When a house has three openings, it is तिनद्वारा *tindara* or सोदरा *sodra*; with twelve openings, it is बरदारी *bardari* or बरबन्दारी *barahdari*. But these terms are not much used except south of the Ganges, from and including Patna westwards. A house provided with lattices is जाळदार *jāldār* or जाळीदार *jāldār*. A house with nine apartments is in Patna and Shahabad नौरतन *nauratan*. Rooms in a native house are generally nine cubits long by five cubits wide. Such rooms are called नौपचम *naupancham*. बासा *bāsa* or डेरा *dera* is a dwelling or lodging-house, and खिलवात *khilwat* a house used as a private chapel by Musalmāns.

CHAPTER II.—PARTS OF A HOUSE.

1237. *The courtyard.*—This is आँगन *āngan*, आँगने *āngnai*, or (principally in Patna and Gaya) आँगना *āngna*; also in South Munger एँगना *engna*. In South-East Tirhut it is also called डेरा *dera*. The space in front of a house is अगुवार *aguār* or अगुवारा *aguāra*; also अगुवास *aguwās* in Shahabad, अगुनी *agutti* in Patna and Saran, and अगुवानी *aguwāni* in Patna and the south-east. The space behind it is पिछुवार *pichhuār* or (generally in the oblique cases) पिछुवारा *pichhuāra*, or to the west पछुवार *pachhuār* or (generally in the oblique cases) पछुवारा *pachhuāra*. It is also पिछत *pichhāt* to the west, पिछुनी *pichhutti* in Patna and Saran, and पिछुवानी *pichhuāni* in Patna and the south-east.

1238. *The vestibule or outer entrance room.*—This is दुवार *duār* or दोवार *doār* generally. It is also दूरा *dūra* north of the Ganges,

and दुधारी *dudhāri* or दुधरिया *duariya* in Patna and Gaya. Another name current in Patna and the east is देहरी *dehri*.

1239. *The inner entrance room.*—This is the room in which the men of the family sit and meet outsiders. It is called दलान *dalan*. It is also named दोगाह *dogāh* in South-West Shahabad and दरोका *darokha* north of the Ganges. In Patna दोगाह *dogāh* means a cattle-shed. In North-West Bihar दुमुहान *dumuāhān* is a somewhat similar room, but opening both to the outer world and to the inner apartments. A sitting-room generally is बैठका *baithka*.

1240. *The upper story.*—This is कोठा *kotha*, or in the south-west पटहवाँ *patahuāñ*.

1241. *The under-ground story.*—This is तखाना *takhāna* or तखाना *takkhāna*. Other optional names are भुजबगरा *bhunjabra* or तरबगरा *tarābra* in Patna, Gaya, and the south-east.

1242. *The veranda.*—This is ओसरा *osāra* or ओसरा *osra*, with variants ओसारी *osāri* in South-West Shahabad, उसरा *usra* in Gaya, and ओसरो *osro* in South Bhagalpur. It is also called साप्रबान *sāp̄bān*, and in Shahabad धाबा *dhāba*.

1243. *The sitting-platform.*—This is चौतरा *chautra* generally. Other optional names are चबुतरा *chabutra* and पिन्दा *pinda* in Patna and the south-east, and ओटा *ota* in Patna, Gaya, and Sāran.

1244. *The roof.*—The roof or ceiling is छत *chhat*. It is also छत *chhat* south of the Ganges, छत्ता *chhatta* in Gaya, and छता *chhāta* in South Bhagalpur. A thatched roof is चाउनि *chhāumi*, चौनी *chauni*, चाह *chhānh*, चाही *chhānhi*, or चनिया *chhanhiya* in North-West and South Bihar. It is also generally चपर *chhappar*, with an optional variant चपरी *chhapri* in the south-west. Another name current in Tirhut is चार *chār*. If it is a simple thatch without tiles, it is specially called ठाट *thāt*. A thatcher is गरामी *gharāmi* or चौनिहार *chhaunihār* north of the Ganges, and his work is चाउनी *chhāūni*. In Patna and Gaya he is सुनिहार *sutihār*, and to the south-east घर हरिया *ghar chhariya*.

1245. When a thatch is only a "lean-to" on one wall, it is known as एकपक्षिया *ekpāliya* to the west. In Tirhut it is एकचारी *ekchāri*, and to the south-west एकधारा *ekdhāra*. In Patna, Gaya, and (optionally) the south-west it is एकचपर *ekchhapra*. If it rests on both walls with a ridge pole in the middle, it is दोपक्षिया *dopāliya* to the west and दोधारा *dochāra* in Champāran and to the east. In Patna

it is *पलानी palani*, and in Gaya and (optionally) South Munger *दोखपरा dookhapra*. In Shahabad another name current is *दोखरा dochra*. A roof composed of four triangular thatches meeting in a point at the top is called *चौपार chaupar*. When there are more than one thatch in a roof, each thatch is called *परन्दा pharka* or *पदा palla*. Also in the case of two thatches the front one is called north of the Ganges *पहल के डाठ agūt ke thāt*, and the rear one *पछल के डाठ pachhāt ke thāt*. The thatching along the ridge is *कोथानी kochani*, or in Gaya *दोगा doga*. A small thatch put on the top of a wall to save it from rain is *परन्दाही parchhatti* or *उपरन्दाही uparchhatti* north of the Ganges, and south of it *परन्दाही parchhatti* (with a soft *l*). Other local names are *झौनी chhauni* (North-East Tirhut), *छपरी chhapri* (Tirhut generally), and *पन्दाही panchhatti* in Patna.

1246. To rethatch a roof is *ओतव otab* or *नौठ करव nauthat karab*. The yearly repairs to a tiled roof are *फेरौंडी pheraunti* in the south-west, and elsewhere *खपरा खेरव khapra pherab*. The grass put on a roof to make it water-tight is *फडकन phatkan* in Saran, *हाबव chhāban* in Champaran, and *झौनी chhauni* or *तरैरा tarera* in Patna, Gaya, and the south-west. In Tirhut it is *खरव chharan*, and in the south-east *खारव chhāran*. Mud used for the same purpose is *गिलावा gilāwa*. The repairs to a tiled roof which leaks are *चूचना मारव chūana mārav* in South-West Shahabad, *डोरा तोया toiya* in the rest of that district, *टिपकारी tipkari* in Gaya, and *टपका मारव tapka mārav* in Patna.

1247. *The fireplace.*—This is *चूहा chūha* generally, local variants being *चूह chūh* in Shahabad, *चूही chūhi* in South-East Tirhut, and *चूहो chhūho* in South Bhagalpur. In East Tirhut *चूह chūh* is a fireplace with two orifices, and *कौहा kaulha* one with one. In South-West Tirhut this last is called *एकौहा ekaulha*. The mouth of the fireplace is called *मुँह muñh*, or sometimes *दुआर duār* south of the Ganges. In North-East Tirhut *चिनमार chinmār* is the raised earth platform on which the fireplace is made, and on which food is cooked, while *चौका chauka* is the similar platform smoothed for a Hindu to eat from. *झौना thauna* to the west is a raised platform on either side of the fireplace for receiving pots for straining off rice-water. When the ground is simply smoothed for eating from, it is called *ठहर thahar*, or in East Tirhut *ठान thānu*. *आरा* or *आड़ा āra* is a cupboard in the wall at a man's height from the ground, in which cooking-pots are placed at night. *बोरही borsi* is the moveable fireplace used by jewellers and by villagers (especially females) to warm themselves in winter. In North-

East Tirhut it is बोरस *boras*. घूर *ghūr* is a hole dug in the ground filled with straw and sweepings and lighted in the evening as a fire to warm oneself at. It is also called कौर or कौड़ *kaur* in the west.* The iron or earthen moveable fireplace is अंगैठी *angaiṭhi*. A similar one used by jewellers is अंगैठा *angaiṭha*. An earthen pot for holding fire is in Gaya मटपर *matpar*, and in Shahabad मेंटपर *mentahar* or पौड़ा *paura*.

1248. The holes on the top of the fireplace, on which the pots are placed, are called आँची *ānchhi* or अँचिया *ānchhiya*; also in South-West Shahabad ऐला *aila*. They are also called चुल्हिया *chulhiya* in East Tirhut. When there are places for four pots, it is known as a चरँचिया पूरहा *charānchhia chālha*, or in South-West Shahabad as a चरँचा पूरहा *charāila chulha*. The partitions between the holes are पूता *pūta*, पुता *putta*, or पुनी *putti*. Also पुठी *puti* in South-East Tirhut, and पुतिया *putiya* in South Munger. The cooking-house is amongst Musalmāns बबरची खाना *babarchi khāna*; amongst Hindus it is रसोईघर *rasoiya ghar*; also भन्साघर *bhansa ghar* in Patna and the east. In East Tirhut it is भानसघर *bhānas ghar*. The portion of the cooking-room set apart by a partition for cooking purposes only is called चुल्हानी *chulhāni* or चुहानी *chuhāni*. The other portion is known as मँजघर *mānj ghar* in Saran and South-West Tirhut, as मँजघर *mānj ghar* in Shahabad, and as खोची *khonchi* in North-East Tirhut.

1249. *The door.*—A doorway is दुवार *duār*, दोवार *doār*, दुवारी *duāri*, दरवाजा *darwāja*, दरवाजा *darwājja* or (in Patna, Gaya, and the south-east) दरोजा *darauja*. A door is कँवाड़ी *keṅwāri*, or in East Tirhut केवाड़ *kewār*, केवाँड़ी *keṅwāṭri*, केवाँड़ *keṅwāṭr*. The main doorway is सदर दरवाजा *sadar darwāja*; also निकसघर *niksār* to the west, and निकस *nikās* in East Tirhut. In South-East Bihār it is समुख दरोजा *samukh daroja*. A gate is फाटक *phātak*. A side door or window with lattices is खिरकी *khirki*; also दरैची *darainchi* in Patna and Gaya. बहाँरी *bhāwāri* to the west and in West Tirhut, भँभरा *bhambhira* in East Tirhut, and to the west दरौची *darinchi*, is a hole pierced in a wall to give light and air. In South Munger it is भमरा *bhamra*, and in South Bhagalpur भौरा *bhōira*. In Patna and Gaya it is ताबदान *tābdān*. मुक्का *mukka* or मोंका *monka*, and in Champāran अँधारी *andhāri*, is an earthen pot fixed in the wall for holding pice, &c. The leaves of the door are

* Compare the proverb घर जरेदि, घूर बुवाव *ghar jarainki ghūr butāv*,—when his house is on fire he puts out the *ghūr*, i.e. in many difficulties he grapples with the least.

बत्ता *palla*, or in Shahabad बत्ता *pāla*, and the strip of wood nailed on one leaf to cover the ohink is बनी *beni* or बेनीयाँ *beniyān*. In South Bhagalpur this latter is बेना *benā*. The cross-pieces across the leaf of the door to hold the boards composing it together are बत्ता *bāta* or बत्ता *batta*. There are generally four of them.

1250. The door-frame is चौकठ *chaukath*. The top bar or lintel of this is उपरौटा *uprauta* or (in Tirhut) चात *chhāt*. The bottom bar or threshold is लतमरा *latmara*, लतमरवा *latmarwa*, or लतमोरा *latkhora*. Sometimes a second outer door-frame is added for the sake of ornament. This is called साह *sāh* or दसौदी *dasaurhi*, and such a double door-frame is said to be दोहरा *dohra* or साहवाला *sāhwāla* or दसौदी चौकठ *dasaurhi chaukath*. In contradistinction from this, the single doorway is सादा *sāda* or एकहरा *ekahra*. The pivot used as a hinge is चूर *chūr* or (in Patna चूल *chūl*). In South-West Shahabad it is चूर *chūr*. A similar kind of hinge is in Gaya जङ्कौट *jhankaut*. The wooden bar used for fastening the door is बिल्ली *billi*, and also (to the extreme west) आगर *agar*, आगल *agal*, or अग्रो *agri*. In South-West Shahabad it is दन्दा *danda*. A short bar fastened by a pin to, and revolving on, one leaf of the door, and falling on a nail fixed on the other leaf, is बिल्ली *billi* or बिलैया *bilaiya*. The nail is called मकरी *makri*. A European door-bolt is चिटकनी *chhitkani* or चिटकनी *chhitkani*. The heavy door-bar sliding back into a recess in the wall is बेंक *benr* or बेंका *benra*. South of the Ganges the धेंकी *dhenki*, or in Shahabad धेंका *dhenka*, and in the south-west of that district ठेकुरी *thekuri*, is a perpendicular bar sliding down from a recess in the top of the door-frame. गरका *gharka* (in South Munger) is a kind of bolt. The door-lock is ताला *tāla*, and the key कुञ्जी *kunji*, चाबी *chābhi*, or चोरोना *chhorna*. The bolt of the lock is उरका *hurka* or (in Shahabad) जार *jhār*. In South Bhagalpur उरका *hurka* also means a piece of wood fastening the two door planks behind. When a screen or hurdle, which is टाठी *tāthi* or ठाठी *tāthi* or (to the west) ठठर *thatar*, is used for a door, the spar that supports it inside is बेंक *benr* or बेंका *benra*. In Tirhut it is also बेराठी *berāthi*, बराठी *barāthi*, or (to the east) बेनाठी *benāthi*. In South-East Bihar it is बेराठी *beṛāthi* or अरुखर *arkhar*, and in South-West Shahabad बेवर *beṅwra*. The straw buffers tied along the two door-posts, against which the edges of the hurdle rest, are मोक *mokh* or मोका *mokha*.

1251. The wall.—A wall is दिवार *diwār* or मोह *bhit*. Sometimes the Hindi forms दीवाल *diwāl* or देवाल *dewāl* are used. The foundations

are *नेव* *neo*, and also in Patna and the south-east *दावा* *dāwa*. The straw mixed with earth for building a mud wall is *पाचर* *pāchar*, or in Sāran *वालन* *alam*. The lumps of damp mud used in building a wall are *लौंदा* *londa* or *धौंदा* *dhondha* in Patna, Gaya, and to the west. To the east they are *गौंदी* *gondi*; also *चेपी* *chepi* in Champāran, *चक्की* *chakki* in East Tirhut, and *लौंदी* *londi* in South-East Tirhut. In South Tirhut another name is *लोया* *loīya*, and in West Tirhut *चेकी* *cheki*. The stages in which it is built are *रदा* *radda* or *रादा* *rāda*, and also optionally *पीर* *pinr* in Sāran. In Sāran *रदा* *radda* is the piece of the stage which, being the width of the wall, is finished before commencing the next piece. The top of a wall is *भौता* *bhīta* north of the Ganges, and *भौत* *bhit* south of it; also *मौथ* *mānth* in South-West Tirhut, and *मथनी* *mathni* in East Tirhut. The plank over the top of a doorway on which the wall is built is *भरौंठ* *bharānth*, *भरैठ* *bhareth*, *भरैठ* *bharaiṭh*, or *भरनठ* *bharnath*. In Gaya it is *भरना* *bharna*, and in Patna *पटदेहल* *patdehal*, of which a local variant in Sāran is *पटदेहर* *patdehar*. To the east it is also *जहकट* *jhankat*. If this plank is not equal in width to the wall, two or more are laid side by side. Then the plank in which the top pivot of the leaf of the door moves is *गरनाक* *gardānak*, or in Champāran *उपराँटा* *upraunta*, and the others are called *भरैठ* *bhareth*, &c. An arched recess in the wall over this plank, and serving as a cupboard, is *दुरौंठ* *duraundh* or *दुरौंदा* *duraundha*, or in East Tirhut *चाह* *chhāt*. The gable-end wall of a house is *पाखा* *pākha*, or in Shahabad *पाख* *pākḥ*. In North-East Tirhut, however, it is *चममार* *chanmār*, and in Gaya and South-East Bihar *कनेटा* *kaneta*.

1252. *The eaves*.—These are *ओलनी* *olti* generally, also *ओरी* *ori* to the north and west. Another name current in the west is *ओरिचानी* *oriyāni*. In Gaya and the south-east they are *अग्रै* *agri*, and there and in the south-east *ओहारी* *ohāri*. The edge of the eave, which is finished off with a board or with a kind of long straw or reed wisp, is known as *मोहबत* *mohabbat*; also as *पसौंर* *pasaunrar* in North-West Tirhut, *पंसरौंठ* *paneraunr* in Champāran, and *पनिआगर* *paniāgar* in North-East Tirhut. The last three words are also used to mean the long bamboo which supports the eave along its lower edge. The pieces of wood let into the wall to support this are *तेरवा* *terua* generally, and *तरक* *tarak* in North-East Tirhut. In Shahabad they are also called *मरवा* *marua*. The slope of the roof is *तारन* *tāran* to the west and *गरह* *garah* to the east; also *गरहगर* *garahgar* in North-East Tirhut and *तरंगर* *tarangar* in Champāran. The raised ground under the eaves is in Gaya *अस्थी* *asthi*.

1253. *The cupboard.*—This is बाबा *tākha* or बाब *tākh*. A wall-bracket for lamps is दिबर *diarakh* or दिबरखा *diarkha*; also देखर *dekhar* or देखरा *dekhra* in South-West Shahabad, धोरखा *dhorkha* in Patna and Gaya, and धरखा *dharkha* in Gaya and South Munger. In North-East Tirhut it is चक्का *chakka*, and in South-East Tirhut चिरकद्दान *chirakdān*. In North-East Tirhut खरिक्कौना *kharikautā* is a hole in the wall for keeping tooth-picks. In South-West Bihar and Gaya this is धुरकी *bhurki* or धरकोठी *kharkoti*. मुक्का *mukka*, &c. (see § 1249), is an earthen pot fixed in the wall and used for holding pice, &c.

1254. *The men's and women's quarters, &c.*—The men's quarters are मरदाना *mardāna*, and also मरदानी *mardāni*. Other terms used are दलान *dalān*, दरवाजा *darwaja*, or दरौजा *dārauja*, दुवार *duār*, and (south-east) बंगला *bangla*. The women's quarters are अन्दरत *andarāt*, जगना जिना *janāna kita*, or हबेली *habeli*. To the east they are also called डेरा *dera*, and (in North-East Tirhut) अंगना *angna*. The part between the two is डेरही *deurhi* or (south-west) देरही *deurhi*. This word is often used to signify a whole house, especially that of some great person, i.e., equivalent to 'palace.' The outer room is also बाहर घरा *bahar ghara* or (South-East Tirhut) बन घरा *ban ghara*.

CHAPTER III.—MATERIALS USED IN THE CONSTRUCTION OF THE HOUSE.

1255. Building materials are अमला *amla* or सांगर *sāngar*, or to the south-east सांग *sānga*.

1256. *The posts and beams.*—The wooden pillars supporting the roof are खम्बा *khambha*, खम्बी *khambhi*, खम्बिया *khambhiya*, or खम्बिया *khambhiya*. Another name current to the west and in South Tirhut is थून्ही *thūnhi* or थून्ही *thūnhi*. In North-East Tirhut another name is उच्चर *uchcar*. In South Bhagalpur we find खम्बा *khambhān*, and in South Munger खम्बी *khambhi*. Sometimes to support the ridge-pole a cross-beam runs across from wall to wall, and on its centre stands a pillar, on the top of which the ridge-pole rests. This pillar is also supported by two struts running obliquely from the beam and meeting it half-way up. This beam is called धरान *dharan*, the pillar is called मनिक्कम्ब *manikthambh* or मलिक्कम्ब *malikthambh* or (in Shahabad) also कौरी *kauri*, and the props are called पन्की *pankhi* or in Champaran सिपवा *sipwa*. When this is found too expensive, two struts run up from opposite walls, and cross

each other just under the ridge-pole, which rests on their upper angle. The struts are called भित्तभेदा *bhitbhera*, घोड़मुर्चा *ghormuhān*, or कैची *kainchi* to the west. Other names for similar supports are हडका *halka* and गोड़िया *goriya* in Shahabad, कौचक *kauā* in Patna, Gaya, and South-East Tirhut, कहरै *kahui* in South-West Shahabad, घोड़मुर्चा *ghorsaha* or घोड़ी *ghori* in Champāran and North-West Tirhut, कैच *kainch* in the east generally, and गैच *gainch* in South Bhagalpur. The डेरवा *terua* (or in South-East Tirhut कलान्दरा *kalandara*) is a strut running out from a wall to support the eaves. पावा *pāya* is an earthen pillar for supporting the roof.

1257. The ridge-pole is बरैर *barenr* or बरैरी *bareñri*, also सरन्ही *larhi* in Champāran and the south-west, and नरन्ही *narhi* in North-West Tirhut. All the beams of the thatch cross each other over this the upper angle of the cross is filled in with grass, and the whole is tied up tightly. This filling in is called मंगरी *mangri*. The sloping ridge-pole down a corner where two thatches meet is called तरक *tarak*. A beam running horizontally the length of the thatch along the centre, each end resting on the slope of a gable, is called कमरबन्धा *kamarballa*, also पाड़ *pār* in North-East Tirhut. A lean-to thatch forming the roof of a verandah is supported on a series of struts projecting from the wall, which are called डेरवा *terua*, माळा *māla*, महुवा *mahua*, मरुवा or मरवा *marua*, or मंरुवा *mañrua*, which support a long beam or bamboo, called सरन्दर *sardar*, on which the thatch rests.

1258. The round rafters of a thatched house are बन्ना *balla*, also बाळा *bāla* in Shahabad. Thick squared rafters are known as कड़ी *kari*. The rafters of whole bamboos are कोरा *kora* or कोरो *koro*. The thickest of split bamboo are बाता *bāta* or बत्ता *batta*, and the thinnest laths of bamboo are बातो *bāti* and बत्ती *batti*, also in North-East Tirhut झोंझन *jhonjhan*. निगसा *nigasta* is a thick rafter used in South-West Shahabad; बरगा *barga* are the thinner rafters used in supporting a flat *pakka* roof. बली *balli* are rafters smaller than a बन्ना *balla*.

1259. The round poles built up inside mud walls are लेवा खाम्ही *lewa khāmhi* north of the Ganges. In Shahabad they are गोळ *gol* or गोळा *gola*, and so also in the south-east. In Patna they are लार *lār*, and in South Bhagalpur नार *nār*. The support of a broken wall is अस्थम *astham* or चाँड़ी *chāñri* north of the Ganges; also चाँड़ा *chāñra*, उचका *uchka*, or थमुवा *thamua* in South-East Tirhut. In Shahabad this is थुन्ही *thāñhi*, in Patna and Gaya थुम्भी *thumbhi*, in South Bhagalpur

बहुधा *thamha* or चौडा *chānda*, and to the south-east चौडगनी *othgani* or चौडगन *othgan*.

1260. गोल *gol* or गोला *gola* are round beams, and चौकोर *chaukor* or चौपहाल *chaupahal* squared beams. The latter are also called चौघार *chauthār* in Shahabad. A crooked beam is said to be कुबड़ *kūbar* in Shahabad.

1261. In South-West Shahabad चैड़ा *cheira*, in South Bhagalpur चेला *chela*, and elsewhere south of the Ganges चैला *chaila* or चैली *chaili*, are splinters of wood, a layer of which is placed between the rafters and the tiling, and is also used for fuel.

1262. *The tiles.*—These are खपरड़ा *khapra* generally. Flat tiles are इपुआ *ihapua*, or in Champāran पथुआ *pathua*, and in South Munger सुपतिआ *supatiya*. Another name is पटरी *patri* in South-West Shahabad. Semi-circular tiles are नरिया *nariya* generally, and pointed eave-tiles are टोंटी *tonti* or (Shahabad) टोंटियारी *tontiyari* south of the Ganges. In the north-west चौंथा *aundha* is a rough mode of tiling, when only flat tiles are used. In Gaya मुंगरा *mungra*, and in Sāran मंगरा *mangra*, is a large kind of tile laid along the ridge of a roof. Bits of broken tiles are मरकन *markan* to the north-west, and जिहकी *jhitki*, झुटका *jhutka*, or झुटकी *jhutki* to the north-east. South of the Ganges they are ठिकरी *thikri* or ठिकनी *thikni*. In Shahabad they are ठिकरी *thikri* or ठिकनी *thikni*. Tiles are baked in a kiln, called आवा *āwa* or (South-West Shahabad) आवा *āwān*. The layer of loose grass on a tiled roof between the rolls of thatching-grass and the tiles are known south of the Ganges as तरेर *tarer* or तरैरा *tarera*, or (in South Bhagalpur) पटोतन *patotan*. In the north-west it is फटकन *phatkan*, and in Tirhut चरण *chharan*.

1263. *The bricks.*—These are ईटा *inta* generally, local variants being ईट *int* or ईटा *ita* south of the Ganges, and ऐंटा *ainta* in Patna, Gaya, and South Munger. A well-known proverb is मन में आन बगल में ऐंटा *man meñ ān, bagal meñ inta*,—(pretending to have) something else in one's mind, and having really a brick under one's arm (to heave at you). Among the varieties are पक्का *pakka* or पाकल *pakal*, which are kiln-burnt (the first word is borrowed from Hindi), and कच्चा *kachcha* (also Hindi) or कान्च *kānch*, which are sun-dried. Another classification is into अंगरेजी *angreji* or बरका *barka*, which are large table-moulded bricks. These are also called गढ़िया *gadahiya* in Patna and South Bhagalpur, and टाली *tali* in South Munger. Common country bricks are देहाकी *dehati*, or in South-East Tirhut भुइलोट *bhuihot* or चनगिहा

panginja. *सौंदर saundar* in Patna and the south-east is a yellow kind of country brick. The smallest-sized country bricks are *लहौरी lahauri* or *लहाउरि lahauri* to the west, *पजार pajāi* in South-West Tirhut, *लखौरी lakhauri* in East Tirhut, *खजवा khajwa* in South-East Tirhut, and *ठिकरिया thikariya* in Patna and the south-east. The bricks forming the segment of a circle, used for lining wells, are known as *बकौ bakau*, *बँकौ bankau*, *बकवा bakwa*, or *बँकवा bankwa*. In South-East Tirhut these are known as *चाकैठा chākaita* or *कोठिया ईंटा kothiya inta*. *सुरजमुखी surujmukhi*, or in Champaran *गेंडुवावा geñruāwa*, are the bricks, narrow at one end and broad at the other, used in building the sides of wells.

1264. In the interior of Patna *थवाई thawai* is the name of the bricklayer caste. Bricks are burnt in a kiln, called *पजावा pajāwa*, *पिजावा pijāwa*, *पिजवा pijwa*, *भट्टा bhattha*, or *भाठी bhāthi*. An over-burnt brick is *जहाँवाँ jhāñwāñ* north of the Ganges, and *जामा jhāma* south of it. Local names are *जाम jhām* in East Tirhut and *जामो jhāmo* in South Bhagalpur. Half-fired bricks are *पीयर piyar* or *पियरा piyara*, other local names being *सुरुरिया bhusuriya* or *सेवरवावा sewrāha* in Champaran, *सेवर sewar* in Shahabad, *पीला pila* in Gaya, *अवाळ awālu* in Patna, and *कचकोच kachkoh* in South Bhagalpur. Other names are *भटरङ्ग bhatrang* in North-West Tirhut and *सुरुरङ्गा bhusuranga* in South-East Tirhut. The outer bricks of a kiln which become half black or are partially fired are called *खाल के ईंटा chhāl ke inta*, and in South Bhagalpur also *खाल्टी chhālṭi*.

1265. *Stone*.—Stone is *पत्थर patthar* or *पत्थल patthal*. Slabs of stone are *पटिया patiya* or *सिल्ली silli*. When large they are also called *चौरा chira* in Shahabad, and *असार asār* in Patna and Gaya. Small pieces for jambs and lintels are *ढोड़िया toriya* in South-West Shahabad, *तटन tatan* in the rest of that district, *कचरी kachri* in Gaya, and *धोका dhoka* in Patna.

1266. *Lime and mortar*.—The calcareous nodular limestone used for lime-making and road-metal is known generally as *कंकड़ kankar*, local names being *आँकड़ ānkar*, *इकड़ी ikri*, or *इंकड़ी inkri* (also in South-East Tirhut) to the west, *गङ्गट gangat* in Patna and Gaya, and *गोंगट gingat* to the south-east. Large blocks of it are known south of the Ganges as *चट्टान chattān* or *चटान chatān*, also as *लैन् लान lain* in South-West Shahabad. The small pieces for road-making are *आँकड़ी ānkri* or *आँकड़ ānkar* in Shahabad, *कंकड़ी kankri* in Gaya, and in Patna, Gaya, and the south-east simply *ढोड़ा lora* or *रोड़ा rora*, which last may also

apply to small lumps of bricks, &c., also used in road-making. चररा *chharra*, or in the south-east बाखिब *bālis*, is coarse limestone gravel.

1267. Lime is चूना *chāna*, चूना *chāna*, or चूना *chūna*. It is of two varieties, viz. गिट्टी *gitti*—that made from limestone, and काली *kali*—that made from shells. In the south-east that made from gravel is also called काली *kali*. The mussel shell used for making lime is खोपी *spi*; north of the Ganges, and सिनुवा *situs* or सिनुवा *situa* south of it. A local name is सिनु *sittu* in South Bhagalpur. गोंगा *ghongha*, शैला *aiha*, or ऐंला *ainha* is the voluted shell of a kind of water-snail similarly used. Lime mortar is मसाला *masala*, or in Patna दबोद *daboi*. Plaster is लोदाच *ledal* or नोपे *nipe*. Moistened clay used as mortar is गिलावा *gilawa*, or in South Munger गिलेवा *gilewa*. In Patna, Gaya, and the south-east it is also called गारा *gara*. The pounded bricks used as a substitute for sand is सुरखी *surkhi*. When a wall is whitewashed it is said to be पोचारा वाला *pochāra wala*, चुनेटा *chuneta*, चुनकटा *chunokatta*, or चूना चररा *chāna pheral*.

DIVISION XI.

FOOD.

CHAPTER I.—MEALS.

1268. The general term for a meal is रसोद *rasoi*; also भानस *bhānas* in East Tirhut. The morning meal is नाश्ता *nāshta*. Other names are पनपिबार *panpiyāo*, पनपिबार *panpiyāi*, जलपान *jālpān*, जलखई *jalkhai*, and जलखावा *jalkhāwa*. Other local names are जलघेराव *jalgherāw* (Champāran), पनपिबार *panpiyār* (Gaya), and दाना *dāna* or दाना दुनी *dāna dūni* in Shahabad. पनपिबार *panpiyāi* is also used to mean the food eaten by the labourer in the intervals of work in the field. This in the west is also called लुकुम *lukum*.

1269. The *midday meal*, which is the main meal of the day, is called by the people कलेवा *kalewa*, कलेव *kaleu*, or (in Tirhut) कलौ *kalau*, though according to dictionaries and pandits this is a light morning repast. Local names for this meal are खाव *khāy* in Patna, खेवा *khāiya* in Gaya, खारक *khāik* in South Munger, and कलौवा *kalaua* in South Bhagalpur.

1270. An *evening meal* is संझौवा *sanjhāwa* in South-West Shahabad. बेबासू *beāsu*, or in Champāran बेरहतिवा *berhatiya*, is light food taken just before sleeping.

1271. A *mouthful*, or the quantity of food put into the mouth at once, is कोर *kor*, कवर *kawar*, or कौर *kaur*. In South-West Shahabad it is also नेवावा *newāla*, which, however, means in the interior of Patna the refuse food left, after eating, for servants, and which is then also called अलुस *alus*.

CHAPTER II.—KINDS OF FOOD.

1272. The following are the principal kinds of food consumed by the lower orders:—

अकरी *akri*, एकरी *ekri*, or एंकरी *enkri*,—uncleaned rice.

- अखरी *akhri* or (South Munger) अखरा *akhra* or (South Bhagalpur) अखरो *akhro*, also आँवट *āṅwat* (North-West Bihar and South-East Tirhut),—barley ground without being first cleaned. Cf. गूरी *gūri*.
- अदौरी *adauri* or (Shahabad) अद्वरी *advāri*,—little round balls made of pulse.
- अनाज *anj*,—a general term for food, especially grain.
- अन्न *ann*,—food generally, especially corn.
- अमावत *amāwat* (west), अमोट *amot* (North-East Tirhut),—mango conserve.
- अरकौंच *arkaunch*,—see रिक्कौंच *rikaunch*.
- अरदावा *ardāwa*,—gram and barley mixed and parched. Used as a food for horses.
- अमांठी के रोटी *amān̄thi ke roti*,—see आंठी के रोटी *ān̄thi ke roti*.
- आंटा *ānta* or आटा *āta*, पिसान *pisān*, कनिक *kanik* or (East Tirhut) चिकस *chikas*, and (South Bhagalpur) चिकन्हा *chikha*,—flour or meal.
- आंठी के रोटी *ān̄thi ke roti*, also किसन्ही के रोटी *kis̄hi ke roti* (Champāran), अमांठी के रोटी *amān̄thi ke roti* (Gaya and South Munger), and गुम्मा *gumma* (South Bhagalpur),—bread made of crushed mango-stones.
- आमिल *āmil* (North-East Tirhut), खटार *khatai* (Sāran), and अहा *khatta* (South Bhagalpur),—dried chips of the mango fruit used as a conserve. It is of two kinds, दरिमी *darimi* and खोरवा *khoiwa*. The first is made from small immature mangos (टिकुला *tikula* or टिकोहा *tikorha*), and the second from large mangos.
- आँवट *āṅwat*,—see अखरा *akhra*.
- ओग्रा *ogra*,—see मॉड़ *mānr*.
- ओरवा *orha*,—see ओरन्हा *horha*.
- इमरिती *imriti*,—see जिलेबी *jilebi*.
- इंगूर *ingūr* or इंगुरी *inguri* (north),—barley from which the husk has been removed by pounding.
- उमिहा *umihā*,—cooked mustard-seed.
- उमी *ūmi*,—green *marua* (*eleusine coracana*) roasted as food (see § 990).

उदका दाह *ulca dal*, उदावद *uldawal*,—see दाह *dal*.

एकरी *ekri*, ऐकरी *enkri*,—see अकरी *akri*.

कचवनिवा *kachvaniya* (Sāran, Patna, and South Munger), मोदक *modak* (Gaya and Shahabad), कसर *kasār* (South Munger),—a round sweetmeat made of rice-flour, sugar, and clarified butter.

कचरस *kachras* (north-west) or कचुर्चा *panudā* (South-West Shahabad),—sugar-cane juice mixed with water.

कचौड़ी *kachauri*,—cakes of flour filled with pulse, &c. The inside stuffing of pulse-flour, &c., is called पीठी *pithi* south of the Ganges.

करुवा *karhua* (south),—food saved from supper for the children.

कबूली *kabūli*,—see क्विचुड़ी *khichri*.

कनिक *kanik*,—see चाँटा *anta*.

कसर *kasār*,—see कचवनिवा *kachvaniya*.

काँची *kānchi*,—see करुवा *halua*.

किसली के रोटी *kisli ke roti*,—see चाँटी के रोटी *anthi ke roti*.

कुन्ती *kunti*,—see लार *lāi*.

कोंहरौरी *konhrauri*,—cakes made of ground pulse and pumpkin.

कज्जा *khajla* (north),—a sweetmeat made from wheat-flour.

कजूर *khajūr*, also (south of the Ganges) खुरमा *khurma* or (South Bhagalpur) जिलिया *jhiliya*,—a sweetmeat in the form of a date.

कटार *khatāi*,—see आमिस *āmil*.

खंडौरा *khanraura*,—see खुड़ी *khuddi*.

खबौनी *khabauni* (south),—a sweet cake of wheat.

खजा *khāja* (north),—a sweetmeat made from wheat-flour.

क्विचुड़ी *khichri*,—rice boiled with pulse; also called कबूली *kabūli* or भूनाल क्विचुड़ी *bhūnal khichri* when spices are added. This last is called चौकी *chhaunki* (i.e. seasoned) in South Bhagalpur.

खिरौरा *khiraura* (South-West Shahabad),—cakes of rice-flour prepared in hot water. Sometimes spelt खिरवरा *khirawara*.

खीर *khīr*, also खीरि *khīri* in North-East Tirhut and बखीर *bakhīr* south of the Ganges,—rice boiled in milk with sugar. See also जावर *jāūr* and तसमई *tasmai*.

- खुरी *khuddi*, also (South-West Shahabad) खँकौरा *khanraura*, and South Munger मेरखुन *merkhun*,—broken pulse or rice.
- खुरमा *khurma* or South Munger खोरमा *khorma*,—a sweetmeat in form of a date made of wheat-flour, sugar, and clarified butter. Cf. खजूर *khajūr*.
- खुशका *khushka*,—see भात *bhāt*.
- खुसकी *khuski*,—see परगवन *parthan*.
- खोबिया *khobhiya*,—see लार *lāi*.
- खोरवा *khōiya*,—see आमिस *amil*.
- गटा *gatta*,—a cheap sweetmeat made of molasses. They are sold for a *kauri* each, and are the delight of boys of the poorer classes.
- गडगड *galbal*,—see डभका *dabhka*.
- गुमा *gumma*,—see चाँडी के रोटी *anthe ke roti*.
- गुरी *gari* (Shahabad),—barley ground after being cleaned, Cf. खहरा *akhra*.
- गुलगुला *gulgula*, also (Shahabad) गुलौरा *gulaura*,—a pudding of wheat and sugar.
- गुलदाना *guldāna* (north-west), also रदारची दाना *ildāchi dāna* (Sāran and South-West Tirhut), and मुकुन्दी दाना *mukundi dāna* (Patna),—a sweetmeat made of wheat.
- गुलाब जामुन *gulāb jāmun*,—a long sweetmeat made of dry ourds (जेना *chhena*).
- गुली *gulli*,—see खोरवा *loiya*.
- गुलौरा *gulaura*,—see गुलगुला *gulgula*.
- गोष्ठा *gojha* (north and south-west), also गोषिया *gojhiya*,—a kind of sweet cake. See also फरा *phara*.
- घटरा *ghatra*, घटोरा *ghatora*,—see पूषा *pūa*.
- घट्ठा *ghattha*,—see लपची *lapi*.
- घटिहन *ghatihan*, घठिहन *ghathihan*,—a general term for cheap grain, such as barley, pease, &c., also (Sāran) any kind of grain which when ground absorbs much water and is not easily digested
- घटोरा *ghatora*,—see पूषा *pūa*.
- घसुवा *ghasua* or घसुई रोटी *ghasui roti*, also चोडुवा *pochhua* (Tirhut)

and सोहारी *sohari* (East Tirhut and Shahabad),—cakes fried in a little clarified butter or oil.

घाठ *ghāth*, घाठा *ghātha*, घाठो *ghātho*,—see लपन्गो *lapsi*.

घाठि *ghātki*,—see बीसन *besan*.

घाँठो *ghāntho*,—see लपन्गो *lapsi*.

घियाड़ा *ghiyaura*, घोवर *ghiwar*, घुगुरी *ghuguri*,—see देवर *ghewar*.

घुघग्नी *ghughni* (north and south-east),—a mess made of pulse, clarified butter, &c.

देवर *ghewar* (north), घुगुरी *ghuguri* (South-West Shahabad), घियाड़ा *ghiyaura* (Patna and Shahabad), घोवर *ghiwar* (Gaya and south-east),—a sweetmeat made of wheat-flour.

घोर *ghor*, घोख *ghol*,—see मट्टा *mattha*.

घोरज्जावर *ghorjāūr*, घोरज्जारी *ghorjāri*,—see मट्टाज्जावर *matthjāūr*.

चक्का *chakka*.—see बज्जक *bajka*.

चटनी *chatni*,—"chutnee."

चबैना *chabena*, चबैनी *chabeni*, चरबन *charban*, or भूजा *bhūnja*, also भुज्जा *bhujna* (Shahabad) and मूही *mūhi* (South Bhagalpur), भूजा *bhūja* (North-East Tirhut),—parched grain.

चिकस *chikas*, चिकसा *chiksa*,—see आँटा *ānta*.

चिकस *chikkas* (north),—roasted barley ground up with unroasted barley.

चिउरी *chiuri* (north-west), चौरि *chauri* (South Tirhut), चरुही *pharuhi* (East Tirhut and Shahabad), चरुही *pharhi* (Patna and Gaya),—unripe barley parched; but in South Bhagalpur, चरुही *pharuhi* is parched rice.

चुनी *chunni*,—see चून *chūn*.

चूड़ा *chūra*,—unhusked rice, parched, then moistened and pounded flat.

चून *chūn* (north-west), चुनी *chunni* (Patna, Gaya, and South Munger), and राई *rai* (Shahabad),—rice partially boiled, then pounded and roasted.

चोखा *chokha* or भरना *bharta*, also (East Tirhut) सना *sana*,—a mess of pounded roasted vegetables.

चोंथा *chontha* (Sāran),—a dish of pulse.

चौरी *chauri*,—see चिचरी *chiuri*.

चौरैठा *chaurētha*, चौराठ *chaurath*,—rice soaked in water and then dried and pounded.

चनका *chhanka*, चेषकन *chheukan*, चेषकना *chhewankna*, चोंकल *chhaunkal*, चींका *chhaunka*,—see बगार *baghār*.

चेना बाड़ा *chhena bāra*,—round flat sweetmeats made of dry curds (चेना *chhena*); a Bangali dainty adopted in Bihar.

चींकी *chhaunki*,—see चिचरी *khichri*.

जवाहार *jawākhār* (south) or पाषक *pa:hak* (South Bhagalpur),—ashes of burnt ears and stalks of barley, used as a cure for indigestion.

जावर *jdūr*,—rice boiled in milk with salt. When boiled with sugar it is खौर *khīr*, *q.v.*

जाबर *jd̄bar*,—a mess of rice, vegetables, clarified butter, &c.

जिलेबी *jilebi*,—a tubular sweetmeat in a coiled shape, made of fine wheat-flour, sugar, &c. A variety of it is known as इमरिती *imriti* or इमिरगती *imirti*.

जांजा *jhānjha* (South-West Shahabad),—a mixture of coarse sugar, hemp, clarified butter, &c.

जिलिया *jhiliya*,—see खजूर *khajūr*.

जिल्ली *jhilli*,—see लट्टा *latta*.

जोर *jhor*,—see परोह *pareh*.

तूका *tūka* (north) or (East Tirhut) तुकरी *tukri*,—the fourth part of a round cake.

तिकरी *tikri*,—a sweetmeat made of flour, fried in clarified butter or oil, and covered with sugar; also (Gaya) a small loaf or roll. In South Bhagalpur it is a round sweetmeat in the form of a cake, and made of flour, butter, and sugar. Another name for this last is तिकिया *tikīya*.

ठकुआ *thakua*,—see ठेकुआ *thekua*.

थुरी *thurri*,—see थूरी *thūri*.

थूरी *thūri*, or (Tirhut, Gaya, and South Munger) थुरी *thurri*, (South-West Shahabad) थोरी *thori*, (Patna) थुररी *murri*, and (South Bhagalpur) मूही *mūhi*,—grain which has not burst while being parohed.

ठेकुचा *thekua*, ठकुचा *thakua*,—a kind of cake pressed in a mould called अगारौटा *agarautā*.

थोरी *thori*,—see थूरी *thūri*.

दमन्दा *dabhka* (north-west), दमन्दा *galbal* (South Tirhut), दमन्दा *dabhkal*,—parohed unripe grain, or ripe grain soaked in water and parohed.

दुप्पा *duppha*,—see महार *mahuar*.

तक्कर *takkar*,—a preparation of butter-milk with spices, &c. It is said to be very cooling.

तरल *taral* (North-East Tirhut),—a kind of dish consisting of vegetables cooked in clarified butter or oil. It is peculiarly a rich man's food, and is supposed to be fattening, hence the proverb तरल खाव, पुनु गरल खाव *taral khāv, punu garal jāy*,—he is a rich man, and yet he is lean.

तस्मर *tasmar*,—rice boiled in milk with sugar, usually eaten by mendicants. It differs from खीर *khīr* in that the latter may or may not have water added.

तास खानी *tāj khāni*,—see तास खानी *tās khāni*.

तास खानी *tās khāni* (north), also (South-East Tirhut) तास खानी *tāj khāni*,—a round sweetmeat made of rice-flour, sugar, and clarified butter.

तिलकतरी *tilkatri*,—see लार *lāi*.

तिलकुट *tilkut*,—a sweetmeat made of sesamum and molasses, much eaten by boys in Patna.

तिलौरी *tilauri*,—small balls of *urid* or *mung* mixed with sesamum seed, dried in the sun, and then fried in clarified butter.

तिसजौरी *tisjauri* (South Tirhut) or तिसिवाचर *tisiyāūr*,—linseed and rice cooked together.

दरिमी *darimi*,—see आमिद *āmil*.

दन्दाचर *danjāūr* (Sāran and South-West Tirhut),—poppy-seeds (दाना *dāna*) and rice cooked together.

दानौरी *danauri*,—the same as तिलौरी *tilauri*, poppy seeds being used instead of sesamum.

दरा *dara*, दररा *darra* (north),—coarse meal; but दररा *darra* south of the Ganges is pounded maize boiled with water and sugar.

दलपिठो *dalpitthi*, दलपिठौरी *dalpithauri*,—see दाल पीठो *dāl pīthi*.

दलसग्गा *dalsagga* or (South-West Shahabad) सगपहिना *sagpahita*,—pulse boiled with vegetables.

दलन्ही पूरी *dalhi pūri*,—see बेरन्ही *berhi*.

दाल *dāl*,—split pease or pulse. When these are parched they are called उलावाल दाल *ulāwal dāl* or उलूना दाल *ulūna dāl*.

दाल पीठो *dāl pīthi*, दलपिठो *dalpitthi*, or (Shahabad) दलपिठौरी *dalpīthauri*,—(1) balls of wheat or barley-flour stuffed with pulse inside and boiled in water; (2) balls of wheat or barley-flour cooked along with pulse. पीठा *pītha* means balls of meal boiled in water.

धुन्धार *dhuñdhār*,—see फोरन *phoran*.

धोवल दाल *dhōl dāl*, धोवाँच *dhōānch*,—see धोई *dhōi*.

धोई *dhōi* (north and Shahabad), also धोवाँच *dhōānch* (South-West Shahabad), elsewhere धोवल दाल *dhōl dāl*,—soaked pulse.

धोंग *dhong* (Shahabad),—a thick cake.

पकन्मान *pakmān* or पकवान *pakvān*,—sweetmeats.

पनीरा *panīra*,—the tops of the plant called गुम्मा *gumma* (*pharnaccum mollugo*) roasted in a castor-oil leaf.

पनुर्चा *panuñ*,—see कचरस *kachras*.

पापर *pāpa*,—see पापर *pāpar*.

परकिया *parakiya*,—see समोसा *samosa*.

परन्चन *parthan*, also Gaya पलेथन *palethan*, and कुष्की *khuski*,—the dry flour rubbed on the dough as it is being made into cakes.

परन्मल *parmal* (Shahabad),—parched maize or grain. See also होरन्हा *horha*.

पराठा *parātha*,—see फराठा *pharātha*.

परेच *pareh*, रसा *rassa*, रासा *rāsa*, or भोर *jhor*, sauce, such as of vegetables, &c., eaten with dry food.

पलेथन *palethan*,—see परन्चन *parthan*.

पाम *pāg* or (south-east) राम *rān* or (South Bhagalpur) सिर *sira*,—syrup made by melting sugar in water and boiling it down.

जावक *pāchak*,—see जावाकार *javākhār*.

पापर *pāpa* or पापर *pāpa*,—a crisp cake of pulse flour.

पिठार *pīthār* (North-East Tirhut),—rice pounded in water.

पिठा *pittha* or पीठा *pittha*, also to the east बगिया *bagiya*, and in Tirhut बगेया *bageya*,—a kind of boiled pudding made of *sattu* or meal. A smaller variety is called पिठ्ठी *pitthi*.

पिठ्ठी *pitthi*,—see पिठा *pittha*.

पिचान *pisān*,—see चाँटा *anta*.

पीच *pich*,—see मीड़ *mānr*.

पीठा *pittha*,—see पिठा *pittha*.

पीठी *pithi*,—see कचौड़ी *kachauri*.

पूचा *pūa*, also (East Tirhut) पू *pū*, and बडोरा *ghatora* (Patna and Gaya), and बडरा *ghatra* (South Bhagalpur and Gaya),—wheat-flour and molasses mixed and cooked in clarified butter or oil. Cf. मास पूचा *māl pūa*.

पूरी *pūri*, also (north) लुचुई *luchui*, and (Tirhut) सोहारी *sohāri* or सुहारी *suhari*,—thin cakes boiled in clarified butter. They are supposed to be as indigestible as muffins: hence the proverb about one who attempts things he cannot do, च पचे नहिँ, पूरी का मारि *ghyu pache nahin̄ pūri la māri*,—a fight for muffins, when even clarified butter won't digest.

पेठा *petha* (north), also लुचापाग *bhūtpāg* (South-East Tirhut),—candied gourd.

पेड़ा *pera*,—a sweetmeat made of sugar and milk. Those made in Mathura and Gaya are most esteemed. See also लोिया *loiya*.

फरही *pharhi*,—see चिउरी *chiuri*.

फरा *phara* (north-west), गोष्ठा *gojha* (Shahabad), and बगिया *bagiya* (South Bhagalpur),—balls of rice steamed over a pot containing boiling water.

फराठा *pharātha* (north and south-east), पराठा *parātha* (elsewhere),—bread made like pie-crust.

फरुही *pharuhi* (South Bhagalpur), फोकना *phokna* (South Munger),—parohed rice. See also चिउरी *chiuri*.

फुटपूरी *phutpūri*,—see बेरही *berhi*.

फुटहरा *phutahra*,—see लिट्टी *litti*.

फुठरा *phutha* or (South-West Shahabad) फुटहरा *phutahra*,—parohed gram and pease.

फुठेचरी *phutehri*,—see लिट्टी *litti*.

फूलौरा *phulaura*,—large balls of *urid*-flour fried in clarified butter or oil, and then soaked with spices in tyre. It becomes very spongy.

फूलौरी *phulauri*,—(1) (south) a roll of coarse flour cooked by steam in a pot with some water in the bottom, and resting above on twigs; (2) (north) balls of pulse-flour boiled in clarified butter or oil.

फेनी *pheni*,—a frothy sweetmeat made of wheat-flour and sugar. See also बत्तास फेनी *batās pheni*.

फोकना *phokna*,—see फरुही *pharuhi*.

फोरन *phoran*, also (Shahabad) धुआँर *dhuāñr*,—seasoning used with food.

बखीर *bakhīr* (South-West Shahabad), रसियान *rasiyāo* (rest of Shahabad), रसिया *rasiya* (Patna, Gaya, and the south-east),—rice cooked in sugar and water. See also खीर *khīr*.

बगिया *bagiya*, बगेया *bageya*,—see पिठा *pittha*.

बघार *baghār* (north-west), खेवकन *khheokan* (Tirhut), खेवकना *khhewankna* (Patna), खौकन *khhaunkal* (South Munger), खकना *khkanka* or खौका *khhaunka* (South Bhagalpur),—the act of seasoning food.

बचका *bachka*,—see बजका *bajka*.

बजका *bajka* or (Patna) बचका *bachka*, (north बछा *chakka*, (North-West Tirhut) बरा *bara*, (South Bhagalpur) बारा *bāra*,—slices of gourd or vegetable covered with pulse-flour and then fried in clarified butter or oil.

बत्तास फेनी *batās pheni* or फेनी *pheni* (north),—a spongy sweetmeat made of sugar and flour.

बत्तासा *batāsa*,—a spongy sweetmeat made of sugar.

बफौरी *baphauri*,—pulse-flour cooked by steam.

बरजौर *barjaur*,—see बेरहिन *berhin*.

बरफुी *barphi*,—a white sweetmeat made of wheat, flour, milk, and sugar.

बरा *bara* or बारा *bāra*,—cakes of *urid* pulse fried in clarified butter or oil. See also बजका *bajka*.

बरी *bari*,—balls of *urid*, *mūng*, or gram-flour fried in clarified butter or oil.

बहुसाही *balusāhi* or बाहू साही *bāhu sāhi*,—a sweetmeat made of wheat.

बसिया *basiya*,—see बासी *bāsi*.

बाहुरी *bahuri*,—see होरन्हा *horha*.

बारा *bāra*,—see बज्जका *bajka* and बरा *bara*.

बाहू साही *bāhu sāhi*,—see बहुसाही *balusāhi*.

बासी *bāsi* or बसिया *basiya*, also (Shahabad) बासी कुसी *bāsi kūsi*,—food saved from supper for breakfast.

बीरी *biri* (Gaya), a kind of food made of leaves and flour fried in clarified butter.

बुनियाँ *buniyān*,—a small round hollow sweetmeat made of gram-*besan*, fried in clarified butter or oil and covered with sugar.

बेनिया *beniya*,—see बेरन्ही *berhi*.

बेरन्दिन *berhin* or बरन्जौर *barjaur* (Shahabad),—pulse cakes.

बेरन्ही *berhi*, दलन्ही पूरी *dalhi pūri* (north), फुटपूरी *phutpūri* (South Bhagalpur), and also (Tirhut) बेनिया *beniya*, and (Shahabad) बेरन्हीया *berhiya*,—pulse-flour cooked inside a wheat cake.

बेसन *besan* or घाँठि *ghāṭhi* (North-East Tirhut),—pulse-flour.

बोर *bor* or बोर बोर *bor bor* (Gaya and west), सानि *sāni* (South Bhagalpur), सोन *son* (South Munger), the act of soaking dry food, such as bread, in any liquid.

भभन्री *bhabhri*,—see लिट्टी *litti*.

भान *bhāt* (amongst Hindus), खुशका *khushka* (amongst Musal-māns),—plain boiled rice.

बुआपाग *bhuāpāg*,—see पेठा *petha*.

बुजन्ना *bhujna*, भूजा *bhūnja*, भूजा *bhūja*,—see चबेना *chabena*.

भूनल खिचन्ही *bhūnal khichri*,—see खिचन्ही *khichri*.

मप्रदा *maēda* or मैदा *maida*,—fine sifted flour.

मकुनी *makuni* (1) (north),—cakes stuffed with gram-flour; (2) (south) cakes made of pease or wheat-flour. See also लिट्टी *litti*.

मठन्री *matri* (north), मुठन्री *muthri* (South-West Shahabad),—a sweetmeat made of wheat-flour.

महा *mattha* or माठा *mātha*, also मथा *mantha* (South-West Shahabad), घोड़ *ghol* or घोर *ghor* (to the east), and मही *mahi* (South Tirhut),—butter-milk.

मठ्याहार *mathjāūr*, also (east) घोर्याहार *ghorjāūr* and (South Bhagalpur) घोर्यारी *ghorjāri*,—butter-milk boiled in water, with a little rice, &c., added.

मठरी *mathri*,—see मठरी *matri*.

मङ्गलका *mārsatka* (Gaya),—rice-gruel with the rice.

मथा *mantha*,—see महा *mattha*.

महान भोग *mahan bhog*,—see हलुवा *halua*.

महिवाहार *mahiyāūr* (north) and महुर *maher* (South-West Shahabad),—a mess of rice, &c., in butter-milk.

महवार *mahuar* or (South Bhagalpur) दुप्पा *duppha*,—the flowers of the *mahua* (*Bassia latifolia*), soaked over-night, crushed next morning, and made into a cake with flour, gram, pease, or linseed.

महुर *maher*,—see महिवाहार *mahiyāūr*.

माठा *mātha*,—see महा *mattha*.

मौड़ *mānr* (amongst Hindus) and पीच *pieh* or बोगरा *ogra* (amongst Musalmāns),—rice-gruel.

माल पूषा *māl pūā*,—wheat-flour, sugar, and milk mixed and cooked in clarified butter only, thus differing from पूषा *pūā*,
q.v.

मीठी पूरी *mīthi pūri*,—sweet cakes.

मुररी *murri*,—see ठूरी *thūri*.

मूही *mūhi*,—see ठूरी *thūri*, चबेना *chabena*, and लार *lāi*.

मेरखुन *merkhun*,—see खरी *khuddi*.

मैदा *maida*,—see मयदा *maēda*.

मोती चूर *moti chūr*,—a sweetmeat made up of very fine बुजियाँ *buniyān* shaped like pearls.

मोदक *modak*,—see कचगनिया *kachwaniya*.

रई *rai*,—see चून *chūn*.

रस गोला *ras gola*,—round balls of dry curds (चेना *chena*) in syrup; a Bangālī dainty adopted in Bihar.

रसिया *rasiya*, रसियाव *rasiydo*,—see बखीर *bakhr*.

रसा *rassa*, रासा *rasā*,—see परेह *pareh*.

राव *rān*,—see पाग *pāg*.

राव *rāb*,—boiled sugar-cane juice.

रिक्कौच *rikaunch* or रेंडा *saindha* (north), also अरक्कौच *arkaunch* (Tirhut),—a mess of pulse-flour cooked in the leaves of the अरुई *arui* (*Arum colocassia*).

लकठो *laktho*,—see सेव *seo*.

लहा *latta* or लाटा *lāta*, also (South Bhagalpur) जिहो *jhilli*,—a mess made of the flowers of the *mahua* (*Bassia latifolia*), molasses, and parohed grain.

लड्डू *laddu* or लड्डूवा *larua*,—a sweetmeat made up of sugar and cream.

लपसी *lapsi*,—flour of any grain boiled in milk and eaten with sugar. When made with salt instead of sugar, it is called (South-West Shahabad) घाठ *ghāth*, (South-East Tirhut) लड्डू *ghattha*, (South Munger) घाठा *ghātha*, and (South Bhagalpur) घाठो *ghātho* or घाँठो *ghāntho*.

लार *lāi*, also (Tirhut) लूदी *mārhi*, कुन्ती *kunti* (Patna and the south-west), and तिलकतरी *tilkatri* (South Bhagalpur) and खोभिया *khobhiya*,—parohed rice prepared with sugar south of the Ganges, but without it north of the Ganges.

लाटा *lāta*,—see लहा *latta*.

लावा *lāwa*,—maize, rice, &c., parohed in hot sand.

लिट्टी *litti*, लभरी *bhabhri*, लकनी *makuni*, or लड्डूहरी *phutehri* or (south) लड्डूहरी *phutahra*,—various cognate kinds of cakes fried in hot ashes. The last four are generally stuffed with *sattu* and spices, while the first may or may not be so stuffed.

लुचुई *luchūi*,—see पूरी *pūri*.

लोइया *loiya* or (South Bhagalpur) गुल्लो *gulli*, the lumps of dough out of which cakes are made. In Patna, Musalmān women call them पेड़ा *pera*.

लकरपावा *sakarpāla* or (Gaya) मिरजई *mirjai*,—a sweetmeat of wheat-flour.

लगपहिता *sagpahita*,—see दलबन्धा *dalsagga*.

लतुवा *satua*, लतुई *satui*,—see लतू *saṭṭu*.

सतू *sattu* or सतुषा *satua*, also (Shahabad) सतुरै *saturi*, and (north, generally amongst mendicants) सितसुबुकनी *sitalbukni*, parohed gram ground into flour.

समोसा *samosa* also (Tirhut) परकिचा *parakiya*,—balls of flour, with fruit, &c., inside, cooked in clarified butter.

सरबत *sarbat* (south-east),—sugar-cane juice mixed with milk ; also generally *eau sucré*.

सानि *sāni*,—see बोर *bor*.

साँस *sāns*,—a sweetmeat made of बेसन *besan* and molasses, eaten by boys in Patna.

सितसुबुकनी *sitalbukni*,—see सतू *sattu*.

सिधा *sidha* or सौधा *sidha*,—provisions, food, as in the proverb सिधा सन्देह, गब्या गब्या करथि *sidha sandeh, gabya gabya karathi*,—it is doubtful if he should get anything at all to eat from me, and he has the impudence to ask for milk.

सिरा *sira*,—see पान *pag*.

सिरचा *sirua*,—soup.

सुरका चुरा *surka chūra*,—unripe paddy parohed and pounded flat.

सुहारी *suhāri* (North-East Tirhut),—see पूरी *pūri*.

सुजी *sūji*,—the flour from the centre of the wheat grain.

सेव *seo* or (Shahabad) लकठो *laktho*,—a kind of coarse macaroni, differing from सेंवरी *semwai* in not being regularly coiled.

सेंवरी *semwai*,—a kind of macaroni, which differs from सेव *seo* in being regularly coiled.

सैंडा *saindha*,—see रिक्काँच *rikaunch*.

सोहारी *sohāri*,—see पूरी *pūri*.

सोन *son*,—see बोर *bor*.

सहूषा *hahua*, also (Shahabad) कान्ची *kānchi*,—a sweetmeat made of flour, dried fruits, and clarified butter. Musalmāns also add eggs. A superior variety of this is known as महान भोग *mahan bhog*.

सहबुस *hābus*,—green barley roasted as food.

सोरगा *horha* (west), ओरगा *orha* (east generally), also सोहगा *holha* (Patna and Gaya), बहुरी *bahuri* or परमल *parmal* (Shahabad),—unripe grain, roasted in the ear or pod.

सोहगा *holha*,—see सोरगा *horha*.

DIVISION XII.

CEREMONIES AND SUPERSTITIONS OF RURAL LIFE.

CHAPTER I.—MARRIAGE.

1273. *Marriage* is amongst Hindus विवाह *biyāh*, local optional names being शुभशुक्ली *shumangali* (properly the marriage service described in § 1328) in North-West Tirhut and Champaran, and विवाह दानी *biyāh dāni* in East Tirhut. विवाह *biyāh* is common in North-East Tirhut, and बिहा *biha* in South Bhagalpur. Amongst Musalmāns it is सदी *sadi* or शादी *shādi*, निवाह *nikāh* being the less regular form. The marriage contract is अकद *akad* amongst Musalmāns.

1274. The *husband* is everywhere (amongst Hindus) बर *bar* (properly bridegroom), भतार *bhatār*, पीया *piya* or पी *pi* (only used in poetry), पत्नी *pati* or सानी *sāmi*. Local forms are जंबाब *jañwāy* (properly son-in-law) (South-West Shahabad) and in East Tirhut सैने *sāineñ* amongst the lower classes and स्वामी *swāmi* or सवामी *sawāmi* amongst the higher classes. भतार *bhatār* is sometimes specially used to signify a woman's second husband. Musalmāns use the word शौहर *shauhar*. The following words are used by Hindus and Musalmāns indifferently: दुल्हा *dulha* (properly bridegroom), पुरुष *purukh*, मरद *marad*, खसम *khasam*, बदनी *admi* or दरिमी *adimi** (also used in South Munger to mean wife), and खविन्द *khāwind*. South of the Ganges occur अमदी *amdi* and मरदावा *maradāwa*. A wife calls her husband मरद *marad*, or in the localities mentioned above जंबाब *jañwāy* or मरदावा *maradāwa*. In South Bhagalpur she calls him सैने *sāineñ*.

1275. A *wife* is मेहरारू *mehrāru*, रखिरी *istiri*, माउग *māüg* or मौगी *maugi*, बहू *bahu* or बह *bah*, (also, in Champaran, बौह *bauh*) (which means literally daughter-in-law), जन्नी *janni*, बेकत *bekat* (also used to mean husband), जानना *janāna*, जोरु *joru*, and कबिला *kabila*, the last two

* Often spelt by purists आदमी *ādami*.

being principally used by Musalmāns. **जौजी** *jauji* (a corruption of *sauja*) is used only by Musalmāns and Kayasths. When talking to a respectable man about his wife, the word **सवारी** *savāri* or **घर के लोग** *ghar ke log* or a periphrasis is used. Thus they say in Shahabad **सपने के सवारी ऐसी कत अपने के सवारी अलि हा ?** 'has your wife come?'; **रवाँ घर के लोग कहवाँ बाकीँ rawāñ ghar ke log kahwāñ bārīñ ?** 'where is your wife?'; or **रवाँ रबीली में कब ऐसी कत rawāñ habeli mēñ kab āli ha ?** 'when did your wife come?' *lit.* 'when did the being in your honour's inner apartments come?'

1276. When there are two wives, each is **साउत** *saut* or **सौतिन** *sautin* to the other, a South Ganges variety being **सौतिन** *solin*, and in South Munger **सैतिन** *saitin*. The first wife is **बिवाही** *biyāhi*. In Patna and Gaya **बिही** *bihi*, and in Shahabad **मेहरी** *mehri* and **कबिला** *kabila*, are also used in the same sense. When there are two wives, the elder is called **जेठरी** *jethri*, **जेठकी** *jethki*, or **बड़की** *barki*, and the younger **लहरी** *lahuri* or **छोटी** *chhotki*.

1277. A woman whose husband is alive is north of the Ganges **पहवाती** *ehwāti*, and south of the Ganges she is **अहवाती** *ahiwāti* or **अहियाती** *ahiyāti*. A local variety is **ऐहब** *aihab* in South-East Tirhut. **सोहागिन** *sohāgin* is another word used everywhere in the same sense. Another local word in South-East Tirhut is **सधवा** *sadhwa*. When a married woman is living in her father's house she is a **नेहरैतिन** *naihrāitin*, or in South Bhagalpur **सवासिन** *savāsīn*, and when she is living with her husband's family she is **ससुरैतिन** *sasurāitin*.

1278. A *widower* is **रन्दा** *randa* or **रान्दा** *rānda*. If he marries a second time he is **दोषाच** *doḥ* or (in East Tirhut) **दुतिबर** *duṭibar* or **दुबिबाहा** *duḥbiyāha*, and in South Bhagalpur **दोबिहा** *doḥiha*. If he marries a third time he is **तेषाच** *teḥ* or (in East Tirhut) **बितिबर** *bitibar*, and South Bhagalpur **तेबिहा** *teḥiha*. In such case he is also called **दोषाच** *doḥ*.

1279. A *widow* is **बेवा** *beva* or **रान्दा** *rānda*. Another term is **बिधवा** *bidhwa*. In South-East Tirhut **बैधब** *baidhab* is also used. The second marriage of a Hindu widow is **सगार** *sagāi*. Optional names are **सगहम** *sagaham*, **सम्बन्ध** *sambandh* or **समथ** *samadh*, used chiefly north of the Ganges. To the south-east **चुमावन** *chumāvan* or **चुमावा** *chumauna* is also used in this sense. Such a woman is called to the west **अरन्धी** *ardhi*, and the second husband is **सगहवा** *sagāhua* or **संगहवा** *saṅghua*. In Western Shahabad he is **साँघुत** *saṅhut*, and to the west generally

बरण्धुवा *ardhua* or बहार *bhatār*. A child brought forth by the widow previous to the ceremony is पध्मगन्वा *pachhlagwa* or कठनीटा *kathbeta*, or in South Bhagalpur लहबेटा *lahbeta*. The second marriage of a Musalman widow is अकद सानी *akad sāni* or निकाह *nikah*.

1280. A *kept-woman*, who lives with a man without marriage, is रखेलिन *rakhelin*, रखेली *rakheli*, or रखनी *rakhni*. Other names are रखी *randi*, उरहरी *urharhi* or उरहरी *urhari*, and डेमनी *dhemni*. सुरैतिन *suraitin* is used in South-West Shahabad.

1281. The *bridegroom* is दुलगा *dulha*, बार *bar*, नौसे *nause* or नौसे *naushe*. Also, south of the Ganges, गभरू *gabhrū*. In East Tirhut the forms बिखिया *bikhiya* and बिखेया *bikheya* are current. The bride's people call the bridegroom लरिका *larika* or बेटगा *betwa*.

1282. The *bride* is दुलखिन *dulhin* or कनेसाँ *kaneāñ*, also in South Bhagalpur कन्याइन *kanyāin*. The bridegroom's people call her लरिकी *lariki*, लरकिनो *larkini*, or बेटिया *betiya*.

1283. The *dowry* is जहेज *jahej* or दाहेज *dahej*. In South-East Tirhut it is जैतुक *jaituk*.

1284. The *marriage settlement* amongst Musalmāns is मोहर देन *mohar den* north, and दैन महर *dain mahar* south of the Ganges.

CHAPTER II.—WEDDING CEREMONIES GENERALLY.

1285. The *proposal* for a boy in marriage by the girl's relations or *vice versa* is amongst Hindus बरगूर *bartūi* or बरदेखी *bardekhi*, or in Shahabad बरेखि *barekhi*. In South Munger it is sometimes पनवही *panbatti*. In Patna it is occasionally बभन पुखी *babhan puchchi*. Amongst Musalmāns the name for a proposal is निसबत *nisbat*.

1286. The *match-maker*, who conducts the preliminary negotiations, is everywhere अगुवा *agua*. In North and East Tirhut he is also घटक *ghatak*. The barber and Brāhman, who are messengers, and sometimes negotiators, in the matter, are called collectively नौचा ब्राह्मन *naua brāhman*. The searching for a boy in marriage is north of the Ganges, to the west, लरिका खोज *larika khōj*, in South-Tirhut बरगुहारो *bartuhāri* or सुधाबधा करब *sudhābadha karab*, while in North-East Tirhut it is कथा करब *katha karab*. South of the Ganges it is बरगुहार *bartuhār*. Most of these words, however, include the

preliminary negotiations, when a suitable boy has been found. If, during the negotiations, a member of the bride's house visits the bridegroom's, or *vice versa*, the food given him to eat is called *बर्तूही के भात* *bartūhi ke bhāt*. The first food given to him after the marriage under similar circumstances is *भठ्ठे* *bhathkhai*.

1287. The *betrothal* consists in paying the *तिलक* *tilak* on the occasion of the formal proposal and acceptance of the proposal of marriage. This *तिलक* *tilak* is a present made to the bridegroom's people by the bride's people in the bridegroom's house. Some castes pay a portion of this in advance, as a sort of retaining-fee to secure the bridegroom; and when this is done, it is called *फख्दान* *phaldān*, *छेंका* *chhenka*, or *बर छेंका* *bar chhenka*. In Saran and Champaran it is also called *बरछा* *barachchha*, in South-East Tirhut *पञ्चरही* *pancharhi*, and in South Bhagalpur *पन्तोही* *pantohi*.

1288. The man who carries the *छेंका* *chhenka* is the *छेंकरू* *chenkārū* north of the Ganges. South of the Ganges he is *छेंकरही* *chhenkārhi*, or in South Munger *मठ्ठो* *mahton*.

1289. The *period of marriage ceremonies* dates from the presenting of the *तिलक* *tilak*, and is called *लगन* *lagan*, or in East Tirhut *सुध* *sudh*.

1290. The *marriage procession* is *बरियान* *bariyāt*. Sometimes the Hindi form *बारात* *barāt* is used. When it remains at the house of the bride a day after the wedding, the halt is called *बरजाद* *marjād*. When a bride's father is unable through poverty to defray the expenses of the marriage, and he sends her to the bridegroom's house for the performance of the ceremony, she is called *करही* *karhui*, *करुआ* *karhua*, or *दोल करही* *dol karhui*. The marriage procession is the first formal visit of the bridegroom to the bride's house.

1291. The second visit, which consists in the ceremony of going to the bride and bringing her home to her husband's house for the consummation of the marriage, is *गवना* *gawna*, *गवन* *gawan*, or *गौना* *gauna*. In East Tirhut it is also *दुरागमन* *durāgaman*, and south of the Ganges *दुरागौन* *durāgaun*. Another name is *रोकवती* *roksati*, *रोकवही* *roksaddi*, *रोकवती* *roskati*, or *रोकवही* *roskaddi* (رخصني). Yet another is *बिदागी* *bidāgi*.

1292. If the bridegroom pays an intermediate visit, it is called in South-East Tirhut *दुरागमन* *durāgnaghan*. Immediately

before the final visit to fetch the bride, a message is sent to the bride's house with some presents, to announce the approaching of the time for the visit. The presents are called **नेचार** *neār*, and the persons who carry them **नेचारनरवा** *neardharua*. The persons who actually fetch the bride are **लौताहर** *lautāhar*, **नेवतहर** *neotahar*, **लेताहर** *letāhar*, or **लिवावन** *liāwan*, or in South Bhagalpur **लेवारी** *leyāri*.

1293. The *newly-arrived bride* is called **गौनहरी** *gaunahri*. In East Tirhut she is also called **बहुवासिन** *bahuāsīn*. The male members of her party are **लोकनाहा** *loknāha*, and the females **लोकनी** *lokni* or **लोकनिवा** *lokaniya*.

1294. After consummation of marriage, *the first and second visits of the bride to her parents' house* are called **रोकसती** *roksati*, &c., as above. The *second visit of the bride to her husband's house* is **दोंग** *donga*, and her *third visit* is **तेंगा** *tenga*. Her subsequent visits to her husband's or her parents' house are called **रोकसती** *roksati*, **बिदागी** *bidāgi*, **बिदागरी** *bidāgri*, **अवन गवन** *awan gawan*, **बहुरा** *ahura bahura*, **अहोर अहोर** *ahor bahor*, **औरा औरा** *aura baura*, or **आरल गैल** *āil gail*.

1295. A *married girl in her father's house* is called by her people **दरै** *dai*, **धौ** *dhi*, **बबुरै** *babuī*, or **सुवासिन** *suāsīn*. When a wife is in her father's house, and her husband wishes her to return, he sends a messenger (generally a barber by caste) to summon her, who is called **पेठवनिवा** *pethwaniya*.

1296. Their *father-in-law's houses* are called by bride and bridegroom respectively **ससुरार** *sasurār*. The educated also use the Hindi word **ससुराल** *sasurāl*. In East Tirhut it is called **सासुर** *sāsūr*, and in Shahabad sometimes **ससुरा** *sasura*.*

1297. The *wife's parents' house* is called by her in Patna and South Munger **नहिरा** *nahira* or **मेका** *maika*, and in South Bhagalpur **नेहरा** *nehra*. Elsewhere she calls it **नैहर** *naihar*.

1298. The *husband's or wife's maternal grandmother's house* is called by him or her **नानीवाल** *nānihāl*, **ननिवाल** *nanihāl*, **ननिहार** *nanihār*, **ननिहर** *nanihar*, or **ननिऔरा** *naniaura*. Other names are **ममहर** *mamhar*, and (in East Tirhut) **मापिक** *mātrik*.

1299. The *husband's or wife's paternal grandmother's house* is his or her **दादीवाल** *dādihāl*, **ददियाल** *dadihāl*, **ददियार** *dadihār*, **ददियर**

* A man in his father-in-law's house is always made much of, and fed well ; hence in thieves' jargon a jail is called (let us hope sarcastically) **ससुरार** *sasurār*.

dadihar, or ददिहौरा *dadiaura*. Another name current in East Tirhut is पैत्रिक *paitrik*, while in South Bhagalpur they say बपहर *baphar*.

1300. Their *maternal uncle's houses* are his or her ममहर *mamhar* or ममुहर *mamuhar*. So also the *paternal uncle's house* is ससुरार *sasurār*.

1301. The *paternal grandfather's house* is (north of the Ganges) अजिहौरा *ajiaura*.

1302. The *father of the bride and the father of the bridegroom* call each other समन्धी *samdhī*. Their wives call each other समन्धिनि *samdhini*.

CHAPTER III.—SPECIAL WEDDING CEREMONIES AMONGST THE HINDUS.

1303. Marriage ceremonies vary somewhat according to locality and caste. The following is mainly a description of such a wedding as might take place in the house of a well-to-do gosla in Patna, see § 1353. When the marriage has been agreed upon, the father of the bridegroom visits the father of the bride, and each provides a few hand-fuls of paddy (धान *dhān*). These are mixed together, and then divided between the two fathers by a Brāhman, and the bridegroom's father takes his share home. This ceremony is called धानबट्टी *dhanbatti*. This paddy is reserved to be parched in the *chūtha* which will be subsequently mentioned.

1304. Then the females of the bride's family perform the चुमावन *chumāvan* or चुमाणा *chumauna* ceremony. In this five women take rice between the thumbs and forefingers of both hands and touch in order her feet, knees, and shoulders with it. They then put it on her head. To perform this ceremony is चुमाएब *chumāēb*.

1305. On the fifth or eighth day before the expected arrival of the wedding procession, the following preparations are made in the bride's house. If they take place five days previously, they are called पचमंगरा *pachmangra*; if eight days, अठमंगरा *athmangra*.

1306. The ceremony called मठकोढ़वा *mathkorwa*.—The women of the family, and their friends, go singing to a well. They level a piece of ground near the well and smooth it down with लाल माटी *lal māti*, a kind of yellow clay which is generally found immediately over gravel. They then dig a clod up out of it, and carry it home on the head of one of them. They make a

fireplace, चूल्हा *chūlha*, of this mud in the centre of the court-yard or आँगन *āngan*. In South Bhagalpur they set up a plantain-tree and a bamboo in the courtyard, under which they place the mud.

1307. The day before the expected arrival of the marriage procession, the family sets up a bamboo shed in the court-yard over the fireplace. This shed is called मढ़वा *marhwa*, मँडुवा *manruwa*, or मँडो *mānro*, also in South Munger मढ़ची *marhi*, and in South Bhagalpur मण्डप *mandap*. The same day a potter brings an earthen pot, called कलसा *kalsa*, with a four-wicked lamp, called चौमुख *chaumukh*, on its top. This is placed in the house where the family god is placed for the purposes of the marriage. This house is called कोखर *kohbar*. According to some the pot is placed at once in the मढ़वा *marhwa*.

1308. A plough-shaft (हरिष *haris*), a plough-yoke (पाखो *pālo*), and some bamboo twigs (करची *karchi*), are then buried in the ground in the centre of the मढ़वा *marhwa*. Then five men bring out from the कोखर *kohbar* the कलसा *kalsa*, and place it under the मढ़वा *marhwa* in front of the bamboo twigs. The father of the bride then anoints the four posts of the मढ़वा *marhwa* with घ्यू *ghyu* (clarified butter), and on each the mother applies some vermilion (सेनुर *senur*). The name of this ceremony is घुहारी *ghyudhāri* or डीहारी *dhidhāri*. In South Bhagalpur it is गिहारी *ghidhāri*. At the same time worship is offered to the progenitors of the family, which is called मन्त्रीपूजा *mantri pūja*. Then five men take turmeric (हरदी *hardi*), oil (तेल *tel*), and dub grass (दूबी *dūbi*), which they scatter on the bride's forehead. This is called हरदी चढ़ाएब *hardi charhāeb*. Then women anoint her body with oil and turmeric. This is called उबटन *ubtan*, &c.; see § 1342.

1309. Next day, before the arrival of the procession, the paddy saved from the धनबट्टी *dhanbatti* is parched in the fireplace under the मढ़वा *marhwa*. This is prepared for the ceremony of लावा गिहार *lāwa ghitāi* (see § 1332), at the time of the marriage circumambulation. The fireplace is then put to one side.

1310. Next follows the ceremony of *swallowing the mango fibre*. This is called इम्ली घोंटार *imli ghontāi*. In South Bhagalpur a similar ceremony is called अम्लो घोटन *amlo ghotan*. An elder male of the mother's family (usually her brother) puts into her left hand a present of money or ornaments. The barber's wife then gives him the centre fibre of one of the mango leaves hanging up in the मढ़वा *marhwa*, which he presents to the mother's mouth. The mother then bites a small piece off this and deposits it in the hollow

of her own right hand, into which the elder male pours a little water. The piece of fibre is called खरिका *kharika*, तिनका *tinka*—, or दन्ती *danti*. This the mother holds over her daughter's head and gulps (घोंटव *ghontav*, to gulp) it all down. The elder male then says to her, "Art thou cool (*i.e.*, pleased)? (खड़ेख *jurailu*)," to which she replies "I am cool (खड़ेखी *jurailiñ*)."

1311. Wedding wreaths of mango leaves, flowers, &c., are hung over the door, and about the महन्वा *marhwa*. These are, north of the Ganges, बन्दनवार *bandanwar* or बन्वार *banwar*. South of the Ganges they are बन्दनवार *bandanwar*, and in South Munger घेरा *ghera*. In South Bhagalpur mango branches are hung about the house, and are called पल्लो *pallo*.

1312. In the bridegroom's house, before the marriage procession starts for the marriage ceremony, very similar ceremonies are gone through; the महकोढ़ना *maikoriwa* is performed. A चूहा *chūha* is made in the court-yard. The plough-shaft, yoke, and bamboo twigs are buried, and the earthen pot with lights is set up. Only no महन्वा *marhwa* is built. The ceremonies of चुमौना *chumanna* and चरन्ही चहाप्रब *harāi charhāeb* are performed on him, as is done to the bride.

1313. The paddy reserved from the धानबत्ती *dhanbatti* is parched in the चूहा *chūha*. This parched grain is taken with the wedding procession, and mixed with that parched in the bride's house, and with it scattered at the circumambulation (§ 1332).

1314. They then cover him with cosmetic (खबन्ज *abtan*, &c., see § 1342), and his nails are cut by a barber's wife, he sitting in front of his mother, and his mother wearing the *maur* (see § 1326). This, as in the bride's case, is called नखच्छु *nakhchhu* (see § 1326). The ceremony of रसन्ही घोंटार *imlī ghōṭāi* is also observed (see § 1310).

1315. He is then bathed and anointed, and sets out with the marriage procession. A little of the water in which he was bathed is brought with him. This is called सिनेख के पानि *sinēh ke pāni*. He is not allowed to bathe again until the चौधारी *chauthāri* (see § 1340). When the marriage party arrives at the bride's house, this water is given to her mother, and at the time of the girl's नखच्छु *nakhchhu*, the barber's wife will mix it with other water, and bathe the bride with it immediately before cutting her nails.

1316. *The first scattering of rice.*—When the bridegroom arrives at the door of the bride's house, the women of her family receive him,

and scatter over him uncooked rice, the dung of a heifer, balls of cooked rice, and other articles. A married woman of the family then takes a brass pan (चौपी *chhipi* or थारी *thari*) and a small lamp (दीया *diya*) and gives them to the bridegroom; and then, holding two corners of her mantle (चुनरी *chunri*), touches with them the pan, then the boy's forehead, and then her own. This is called परिहावन *parichhāwan*, परिखन *parichhan*, परखान *parchhāwan*, परखन *parchhan*, or परखौनी *parchhauni*. A similar ceremony is called in South Bhagalpur गलसेदी *galsedi*.

1317. *The ceremony of the pestle.*—The girl's mother then rubs in the palm of her hand a curry pestle (खोड़ा *lorha*), which she applies to the cheeks of the bridegroom. This is called गाल सँकी *gāl senki*. This custom is not known in South Bhagalpur. Instead there is performed a ceremony called धूआ *dhūa*. A man disguises himself as a woman and approaches the wedding party with a jar of water. He says he is a woman of Kāmrup (Assam) come to give away the bride. He then sprinkles water on the bridegroom. (Compare § 1320.)

1318. *The marking of the bridegroom's forehead* with sandal paste before marriage is तिलक *tilak* or तिलक *tillak*. In South Bhagalpur it is चन्दन *chundan*. This is done by a man called in the west तिलकबन्धु *tilkahru*, and in the east तिलकदेउवा *tilakdeua* or तिलकिया *tilkiya*. He is generally the bride's father. This *tilak* is quite distinct from the *tilak* paid at the time of proposal of marriage.

1319. These ceremonies at the door are called collectively दुवार पूजा *duār pūja*. In South Bhagalpur they are known as दुवार लगार *duār lagāi*. Those described above are those performed by goālas in Patna. Other castes have other customs,—the higher ones contenting themselves with giving presents to the bridegroom and scattering rice (अच्छत *achchhat*) over him.

1320. The wedding procession then proceeds to put up in a place set apart for them. This is called जनमसा *janwānsa* or (in North-East Tirhut) बैठकी *baithki* or बासगर *bāsghar*, and in South Bhagalpur जनमसा *janmāsa*. A male member of the bride's family (generally her sister's husband) then brings to the जनमसा *janwānsa* a bowl of sweet drink or *sharbat*, called धूआ *dhūa*, and covered with a red cloth. He also brings some urid (*dolichos pilosus*) flour mixed up with finely-powdered pepper. This is called बुकूआ *bukua*. On his arrival at the जनमसा *janwānsa* he scatters this in the air, causing the bridegroom's party to sneeze. He then gives all those

present to drink of the *sharbat*. The whole ceremony is called बुकुआ बुकार *bukua urāi*. A similar ceremony is called, north of the Ganges, धुरच्छक *dhurchhak*, in which water is sent in pitchers, and a little scattered over the party with mango sprays.

1321. The barber now comes for the bridegroom's मौर *maur* or head-dress, as will be subsequently described, which he takes away to the bride's house.

1322. When all is ready the friends of the bridegroom leave the जनदोआ *janwāna* with great pomp, carrying with them the presents for the bride. Amongst these is a valuable cloth, called कनेआ *kaneā*, or in South Bhagalpur बिहौती *bihauti*, which is taken to the female apartments, and in which she is dressed. She is then brought out and made to sit in the मढ़वा *marhwa*. This visit is called निरिछन *nirichchhan*, निरछन *nirachchhan*, or निरछन *nirchhan*, as the bridegroom's party see (निरेखन *nirekhab*, to see) the bride now for the first time.

1323. Then the ceremony of *making the bracelet* is performed. The bridegroom and seven other men husk paddy in a mortar. When husked, two or three grains are wrapped up in mango leaves to form a kind of bracelet. Two of these bracelets are made, and one is tied on to the bridegroom's right wrist, and the other on the bride's left wrist, by a Brāhman. These bracelets are called कङ्कन *kangan* or कङ्कन *kankan*. The ceremony is called अठौंगर *athongar*, अठौंगर *athaungar*, or (in Patna) लठौंगर *lathaungar*.

1324. Then follows the *adoration of the bride*. In this ceremony the elder brother of the bridegroom (or in default of him some elder of the bridegroom's family) offers sweetmeats, molasses (गूर *gūr*), and ornaments to the bride. He then takes some betel-leaf and tyre (दही *dahi*) in his right hand, and presses it against the bride's forehead, at the same time pressing his left hand against the back of her head.

1325. These two ceremonies are together called बन्दन *bandan*, गुरहत्थी *gurhatthi*, or गुरहत्थन *gurhatthan*, and signify that he has touched her once for all, and that if he touch her again he will be guilty of a sin. In South Bhagalpur they are performed by the bride's sister, and both bride and bridegroom are adored. There the ceremonies are called गुराउंधा *guraundha*.

1326. Then the bride's mother sits in the मढ़वा *marhwa* with the bride between her knees, holding her round the waist. The cere-

mony that follows is the *cutting of the nails*. This is called नचन्द्र *nachhhu*, नचन्द्रुषा *nachhhua*, नचन्द्रुषा नचावन *nachhhua nahawan*, नचन्द्रुषा *nachktiya*, or (in Shahabad) नचन्द्रुषी *nahtungi*. In South Munger it is नचन्द्रुषा *nachhundä*, and in South Bhagalpur लौकुषा *lauchhua*. The bride's mother has previously sent (§ 1321) a barber (बजान *hajām*) to the जनवाँसा *janwānsa* to ask for the head-dresses. There are two head-dresses,—one worn by the bridegroom, which is made of talipot-leaves and is called मौर *maur*; the other is worn by the bride, and is called मौरी *mauri*, or (south of the Ganges) पठवासी *patwāsi*, or पठमौरी *patmauri*. The bride's head-dress is made of date-leaves. The barber brings these two to the bride's house and puts the मौर *maur* on the mother's head and the मौरी *mauri* on the bride's head. Then the barber's wife (बजामिन *hajāmin*) cuts the finger and toe-nails of both the bride and her mother (the bridegroom's having been out before he left home).

1327. The bridegroom's party then returns to the जनवाँसा *janwānsa*, and the bride goes inside the house and exchanges her कनेषा *kaneāi* for her wedding dress or पिचरी *piāri* (see § 1348). The bridegroom is then sent for and is seated under the मदवा *marhwa*, and the father or elder male relation brings the bride and seats her beside the bridegroom under the मदवा *marhwa*, to his left. Some one belonging to the bride's family then goes inside and gets the bridegroom's *maur* from the bride's mother, and brings it out, and it is put on the bridegroom's head.

1328. Then the *marriage service* is read by the Brāhman. This is called शुमङ्गली *shumangali* or सुमङ्गली *sumangali*. The bridegroom sits under the मदवा *marhwa* in front of the bride. The father of the bride sits kneeling on one knee, keeping the bride sitting on his other thigh. This is the ceremony of giving the girl in marriage, and is called कनेषाँ दान *kaneāñ dān* or जाँवा (जाँव or जाँघिया) बेरापन *jāngha (jāngh or jānghiya) baisāb*.

1329. It is not necessary to describe particularly the procedure carried out by the officiating Brāhman. He recites (or is supposed to recite) verses from the Vedas, and leads in various acts of worship, such as throwing incense on the fire, throwing rice (चचन *achchhat*) about, worshipping Gauri, and the like. At one period the Brāhman puts into the bride's father's hand a shell containing water, flower, *achchhat*, and metal, and makes him empty it round the base of the earthen pot कालसा *kālsa* on the top of which the lamp with four lights (called

चौमुख *chaumukh*) is burning. He makes him do this five or seven times. This completes the ceremony of कनेई दाज *kaneāñ dāñ*.

1330. From the time of the arrival of the बरिदान *bariyāt* up to the completion of the कनेई दाज *kaneāñ dāñ*, the father and mother of the bride can eat nothing.

1331. Next follows the *knotting together of the clothes of the bride and bridegroom*. This is गेंठ बन्धन *genṭh bandhan* generally. South of the Ganges it is sometimes known as गेंठ जोड़ *geñṭh jor* or गेटजोड़न *gethjoran*, and in South Bhagalpur as जानम गेंठ *janam genṭh*. At the same time something of small value, such as a two-āna piece or a few pice, or sometimes a piece of betel-nut, is tied in the bride's waist-band and in her breast-cloth by the Brāhman. Sometimes an ornament is tied to the bride's sheet, which is called अँचरी पाजो (or पजो) *añchri pālo* (or *pālo*).

1332. The *circumambulation of the sacrificial fire*.—This is sometimes done by both bride and bridegroom, sometimes, *e.g.* in North-West Tirhut, by the bridegroom alone. They or he carry a winnowing sieve. The bride holds it in her hands in front of her, and the bridegroom follows her with an arm passing round her on each side, also supporting the sieve. Her brother fills the sieve as they go along with parched grain prepared in the fireplace formerly under the महुआ *marhwa*, which the bridegroom at the same time scatters by shaking the sieve with his hands (this is called लावा मिरार *lāwa chhitāi* or, in Shahabad, लावा मिरारन *lāwa mirāñ*). Care is taken to keep the sacrificial fire (when there is one) or the altar to the right.* It is considered unlucky for the girl to pass it to her left. This ceremony is called भाँवर *bhāñwar*, अँचरी *bhāñchri*, भौरी *bhauri*, or सत भौरी *sat bhauri*. It is also called बेदि घुमाएन *bedi ghumāñ*. This circumambulation is performed five times, and is the important part of the ceremony. The couple on its conclusion are *fumigated with incense* by the officiating Brāhman. This is called आरत *arat*, आरती *arṭi*, अगती *agṭi*, or अगिवासी *agiyāsi*. In South Bhagalpur it is called होम *hom*.

1333. When this is done, the bride's sisters and her brothers' wives amuse themselves by pushing the bridegroom about, and lifting him up by the ears. This last is supposed to be done five times, but

* The reverse rule is observed by some castes when the horoscope makes out that it is necessary.

is rarely done more than once. It will be seen that this is only done by females. Amongst the Tirhutiya Brāhmins and Kayasths, however, it is done by the bride's brother. The ceremony is called बरक वैसाण्य बडाण्य *barak vaisāṅb uṭhāṅb*.

1334. This is followed by the *application of vermilion*. In this the bridegroom takes a small cup containing vermilion in one hand, and applies vermilion to the parting of the bride's hair with a piece of hemp. This is called सैहर दान *senur dān* or सिन्दूर दान *sindur dān*.

1335. *The stopping at the door.*—The couple then leave the courtyard and go into the house where the family deity is put. This house is called कोबर *kohbar*, or in South Bhagalpur कोबरस *kohbara*. At the door they are stopped by the sister of the bride, who requires the bridegroom to repeat certain verses, called दुरीण *duraundh* or दुरीणा *duraundha*. The bridegroom demands a present for doing so, and on this being given he repeats the verses. This ceremony is called दुवार हँकार *duār chheṅkāi* or दुवार हँकौनी *duār chheṅkauni*.

1336. *The stealing of the shoes.*—The bridegroom takes off his shoes before entering the house. If he is silent or is too nervous to speak much, the bride's sister may, as a joke, steal his shoes while he is inside, and conceal them somewhere, in order to compel him on his reappearance to speak, and say "where are my shoes?" This ceremony is called जूता चोरार *jūta chorāi*. In South Bhagalpur they make the bridegroom bow to a pair of shoes covered with cloth, and the ceremony is called जूता गोरलगार *jūta gor lagāi*.

1337. The couple then kneel facing the north-east, and perform the *worship of the tutelary deity of the family*, offerings being made to him at the same time. This is called गोर लगारण *gor lagāṅb*. The clothes of the bride and bridegroom are then untied, the promised presents given to the sister of the bridegroom, and the marriage is concluded, the bridegroom returning to the जननीसा *janwāṅsa*, and the bride remaining in the house.

1338. Shortly after the marriage, though this sometimes takes place the morning after, the bridegroom goes to his mother-in-law, who feeds him with rice-milk. After eating a little he sometimes takes the rest, dish and all, to the जननीसा *janwāṅsa*, and finishes it there, or sometimes leaves it unfinished. This is called खीर खियाव *khīr khiyāo* or खियावी भान *biyāvi bhāt*, or (in East Tirhut) महुक *mahuak*.

1339. If the bride's people invite the bridegroom's people to stay over the night, it is called मरजाद राख *marjād rākhāb*. This may last

for two or three days or more. On the expiry of the period of *marjād*, the bride's people see the bridegroom's party off. This is called *रोककति करि देव rosakati kari dēb*, &c., as in § 1291. In South Bhagalpur it is also called *लोठकी lotli*. It is managed as follows: The bride's family collects in the court-yard all the presents received from the bridegroom's party, and with the assistance of village friends assesses their value. All this time the bridegroom's party is away in the *जनवाँसा janwāṣa*. When the value has been assessed, the bride's father collects on his side presents to the value of at least one-fourth greater value than those received, and takes them to the *जनवाँसा janwāṣa*. These return presents constitute the dowry, and are called the *दहेज dahej*. The bride's father lays them before the bridegroom's. Then the bridegroom's father takes a new cloth (*चदर chaddar*) and puts it on the bride's father. The bride's father in return presents the bridegroom's father with a purse of money of the value of the *chaddar*. Then both *salām* to each other. Then the bride's father, in token of allowing the other to depart, presents him with a sum of money varying according to means, and a *lota* of water, saying "राम राम *rām rām*," to which the other replies in the same words. This ceremony is called *रामरामी ramrammi*, *मोहन milan*, *मिहन्नी milni*, or *समन्नी मिहाना samdhi milāca*. The two fathers are now, by relation, *समन्नी samdhi* to each other, and in token thereof they exchange cloaks and garlands. These exchanged cloaks and garlands are called *समन्नी samdho*. Amongst lower castes, as the procession is about to start, the bride's father gives each member money sufficient for the way expenses and drink, called *बटवारी batsāri*, and in South Bhagalpur *पाथक pāthak*. Then the procession, bridegroom and all, goes off.

1340. *The untying of the bracelets.*—Four days after the marriage the bride and bridegroom bathe, and the bracelets on their two wrists are taken off. This ceremony is called *चौथारी* or *चोगरी चौथारी* or *चतुर्थी chaturthi*. This is the first washing the bridegroom and bride get from the time of the arrival of the procession before the marriage. During the interval they have been anointed with cosmetics, *उबतन ubtan*, &c.; see § 1342. Usually this is done in their respective houses, but in Patna the bridegroom sometimes goes to the bride's house to perform the ceremony. This concludes the marriage proceedings.

1341. *Miscellaneous.*—The *wedding breakfast* is (north of the Ganges) *कालौ kalau* or *मज्नी majhni*. South of the Ganges, in Shahabad it is *पङ्गत panghat*, and elsewhere *गोरौडा goraudha* or *गुरौडा guraudha*.

The feast at the houses of both parties the day before the marriage procession is *भतवान* *bhatwān*, *भतवानी* *bhatwāni*, or *भोज* *bhāj*. Before eating the guests wash their feet, and the ceremony is called *पर पखारी* *pair pakhāri*, *पेर पखरवा* *pair pakharua*, *पाँव पखारी* *pāñv pakhāri*, *गोड़ धोद* *gor dhōi*, or *गोड़धोचार* *gordhōi*.

1342. The *cosmetic* of turmeric, meal, oil, &c., rubbed on the bride and bridegroom for about ten days before marriage, is north of the Ganges *अबटन* *abtan*, and in East Tirhut *उगटन* *ugtan*, *कसार* *kasār*, or *कासा* *kāsa*. South of the Ganges we find *उबटन* *ubtan* or (in Patna) *ओबटन* *obtan* very generally used; also *आँवट* *āñvat* and *अपटन* *aptan* in Shahabad, *उकटन* *uktan* in South Munger, and *कासा* *kāsa*, *कसारा* *kasāra*, or *उकन* *utkan* in South Bhagalpur.

1343. The *horoscopes* of the boy and girl are everywhere *जनम पत्र* *janam patr* or *जनम पत्ररी* *janam patri*. Also, very generally, *टीपन* *tipan*. In West Shahabad they are also *कुण्डली* *kundlī*. If they agree, the phrase *गन्ना बनब* *ganna banab*, or *जोग मिलाव* *jog milab*, or *रास बरग बैस गेल* *rās barag bais gel*, is used. To calculate the horoscope is *गिनब* *ginab*, or *जोग मिलावन* *jog milāēb*, or *दिन गुन्नी करब* *din gunnī karab*, or *बहन पुच्छी* *babhan puchchhi*.

1344. When the auspicious day for the marriage has been fixed, an *announcing letter* is sent to the bridegroom's father. This is known as the *लगन पत्री* *lagan patri*, or simply as the *चिट्ठी* *chitthī*. The *formal invitation* to the wedding is *नेवन्ता* *neñwta* or *नेवन्ता* *neota*, or (in East Tirhut) *नवत* *nawat*.

1345. The *feast given to the brotherhood at the wedding* is known as *भरचारा* *bhāiāra*, *भरचारी* *bhāiāri*, *भरचारे* *bhāiāre*, *भरचारे* *bhāichāro* (Shahabad), *जेवन्तार* *jeonār*, or *भोज* *bhāj*.

1346. In North-East Tirhut, amongst certain castes, especially the *Bikaua* (बिकौवा) Brāhmans, *caste money* is paid as follows. If the bride's father is of lower caste than the bridegroom's father, the latter pays the former a sum in compensation called *कानेआँ दान* *kaneāñ dān*. In South Bhagalpur this is called *मैन* *main*. If the bridegroom's father is of lower caste, he pays the bride's father a sum of money called *बिकरी* *bikri*.

1347. The *presents* given are as follows:—*सनेस* *sanes*, *दादा* *dāla*, or *दाद दौरा* *dāl दौरा*, are the presents sent by the bridegroom before the arrival of the procession. *दहेज* *dahēj*, as already explained, is the dowry paid by the bride's father. Before the bridegroom leaves after the wedding, he goes to bid his mother-in-law good-bye. She

and the other women give him presents, which are called *सलामी salāmi*. Other similar presents are in South Munger पूरन *pūran*, and in South Bhagalpur चौक *chaunk*. निहावर *nichhāwar*, निहाडर *nichhāūr*, or नेवन्हावर *neochhāwar*, are presents made to the barber and his wife. गैदान *gaidān* or गौदान *gaudān* is the present of a cow made by the girl's father to the family priest (परोहित *parohit*, or (in East Tirhut) पुरोहित *purohit* or अचार्य *achāry*). गुरहत्थी *gurhatthi* has already been mentioned as the ceremony of giving presents to the bride by the bridegroom's elder brother (§ 1325). मोपदेवार *mohdekhāi*, मुदेखौनी *mudekhāuni*, or मुदेखी *mudekhi*, are the presents given to the bride by her mother-in-law or other female relatives of the bridegroom on her first coming to her husband's house.

1348. The पिचरी *piāri*, पीरी *piri*, or (in South Bhagalpur) कनियौनी *kaniāiti*, is the bride's yellow dress, and कन्हावर *kanhāwar* or कंधावर *kandhāwar* is a red loin-cloth laid upon the bridegroom's shoulder during the ceremony.

1349. *Bringing the bride home.*—This is गौना *gauna*, &c., vide § 1291. The procedure is as follows:—When the bride is old enough to live with her husband, an auspicious day is fixed. Some days before the date, the bridegroom's family send a present of sweetmeats, called गौना के नेचारा *gauna ke neāra*. On the evening of the appointed day the bridegroom and his party arrive, and after feasting go off with the bride at dawn next day. The day before, a plough-shaft (हरिष *haris*), but no yoke or bamboo twigs, has been buried in the court-yards of each of the respective families. Before the bride and bridegroom start, their nails are out. This is called नख खार *nakh chhachhāi* or नख खिहार *nakh chhildāi*. With the party the bride's people send one or more gaily-decorated earthen vessels full of sweetmeats, called कुन्दा *kunda* or महार *mahar*.

1350. When the party arrives at the bridegroom's house, the bride passes from the litter to the door, putting her feet into a basket at each step. This is called दौरा में गोर डारब *daura meñ gor dārab* or घर पैसारी *ghar paisāri*.

1351. On entering the dwelling the couple go into the house where the family god is, and worship him. This is called गोर लगान *gor lagāeb*.

1352. As they go into the house, another ceremony, called दुवार खार *duār chhenkāi*, is performed. In this the bridegroom's sister

demands a present, and when it is given or promised she allows them to pass.

1353. *On certain ceremonies performed by Soti Brahmans of East Tirhut.*—Different castes and different localities have various marriage customs, but the one just described may fairly be taken as a standard Hindu marriage ceremony. It describes a marriage such as would take place in a well-to-do goāla's house in the district of Patna.

1354. The Soti Brāhmans of East Tirhut have several curious marriage customs which have existed for many hundred years, some of which will now be noted. The greatest care is kept in keeping up correct genealogies of members of this clan. The genealogical registers are called पंजी *pānji*, and they are kept up by hereditary genealogists called पंजियार *panjiyār*. Once a year or oftener there are great meetings of these Brāhmans at Saurāth, near Madhubani, and other places, where the *panjiyārs* assemble and write up the registers. They also arrange marriages after consulting their registers, and give certificates to the parents certifying that the marriage is lawful, and that the parties are not within prohibited degrees of affinity. These certificates are called अधिकार माला *adhikār māla* or असुजन पत्र *asujan patr*. The settlement of the conditions of marriage is called सिधंत *sidhant*.

1355. When the bride is of equal or higher caste than the bridegroom, the parties meet in a distant place away from both their homes, and the conditions are proclaimed by the *panjiyārs* present. If, however, the bride is of lower caste, the following procedure is adopted:—

The bride and her family leave their house and going a little distance off erect a महवा *marhwa* for the marriage ceremony. On the day appointed for the wedding, the bridegroom starts from his home with his servants under the pretence that he is going out hunting. None of his relations accompany him, and although they, of course, really know for what he is starting, they pretend to be ignorant. When he arrives within a little distance of the महवा *marhwa*, he stops, and then the *sidhant* is proclaimed. By this time the marriage preparations are ready, and the bride's brother comes to him and conducts him to the appointed place. On his arrival at the door the bride's female relatives, each being called for this purpose a बिहकरी *bidhkari*, catch hold of his nose with one hand, and with the other hold a sheet tied round his neck. In this condition they bring him into the महवा *marhwa*, and there the marriage is performed.

1356. After a time the bridegroom's friends pretend that he has been lost in his hunting expedition, and send a man called the **बौध srautra** to look for him. He returns shortly afterwards, and informs them that the bridegroom has married so and so, whereupon they all fall to and abuse him. After abusing him they change their minds and reward him.

1357. At the marriage a barber ties some paddy in a knot in the bridegroom's waist-cloth (**धोती dhoti**). This is called **जानम गेंडि janam genthi**. This is not untied until the fourth day after marriage, which is by this sect called the **चतुर्थी chaturthi**.

1358. Another ceremony is the **दसौत dasaut**. In this a professional dancer (**नटुवा natua**) comes up to the bridegroom and offers him sham sweetmeats (**लड्डू laddu**), in return for which he receives presents. After this the bride and bridegroom go into the **कोषण्वर kohbar** to worship the family god. On the way the bride's female relations set up shops of paltry articles, which the bridegroom is obliged to buy.

1359. Another ceremony is **घास्कट्टी ghaskatti**. In this the bridegroom cuts some grass for his father-in-law, and in return the latter promises to give him a horse.

CHAPTER IV.—MARRIAGE CEREMONIES AMONGST THE MUSALMANS.

1360. The writer is indebted to Kāzi Sayyad Raza Husain of Patna City for the following facts:—

1361. Amongst Musalmāns there are two kinds of marriage ceremonies,—**शरई (شرعی) sharai** and **उरफ़ी (عرفی) urfi**, or religious and ceremonial. The more strict and educated members of the community follow the former, and the common people the latter.

1362. **शरई (شرعی) sharai** marriages are entirely free from ceremonies of any kind. After the betrothal the marriage is performed in strict conformity with the sacred law. The amount of dowry (**महार (مهر) mahar**) is not fixed, but depends on the pecuniary circumstances of the parties. Immediately after the marriage, the wife goes to her husband and is settled for life.

1363. **उरफ़ी (عرفی) urfi** marriages are not so frequent as they used to be. The spread of education and railways has tended to make people stricter in their religious duties, but, specially amongst the lower

orders, the following ceremonies are still in vogue. In these marriages the dowry (महर (مهر) *mahar*) is always fixed. In the cities it is fixed at one *lakh* of rupees, and in the villages at forty-one thousand rupees and one *dīnār*. This is the amount of dowry promised by even the poorest people. It is needless to say that it is never given.

1364. *Arranging the preliminaries*, निश्चयन (نسبت) *nisbat*.—The parents first make themselves acquainted with one another's pecuniary circumstances, and the negotiations are carried on through a female match-maker (सुझाना (مضاتة) *mushāta*). When the preliminaries are settled, a letter of ceremony is sent by the guardian of the boy to the girl's family. This letter is written on red paper, or on white paper sprinkled with red. The carrier of the letter, on arrival at the girl's house, is given *sharbat* to drink, and detained for a day or two. The reply is written on similar paper and returned by him, and this correspondence settles the marriage question. From this time marriage presents are exchanged between the parties, the boy's guardian making the first present. If at this time any women come from the house of the bridegroom on a visit to the bride's house, the bride will not show her face to them.

1365. In some places, before the marriage is decided on the girl's guardians first see the boy. This may be done in two ways: either the girl's people send for the boy to their house, and serve him with betel-leaf, and give him rupees or gold *mohars*, or else the guardian of the bride sends some relative to the boy's house. There, on his arrival, he is given *sharbat* to drink, and the first thing given him to eat is sweetened rice (मीठा चावर *mītha chāvūr*). This relative reports concerning the boy to the girl's guardians.

1366. *Betrothal*.—This is मैंगनी (منگنی) *mangni*. In this the boy's guardian, after consulting with the other party to the contract, fixes a date, on which he sends presents with considerable ceremony. Large coloured earthen pots are filled with sweetmeats and fruits, and sent with a large party. In some places a suit of clothes is also sent. The pots are carried on the heads of maid-servants, who sing songs when they start and when they approach the bride's house. As soon as they arrive they are given *sharbat* to drink, and while they drink the bride's people sing abusive and obscene songs to them. The persons that supply them with *sharbat* receive a small present. The maid-servants are also given sweetened rice to eat in a dish covered with silver leaves and pieces of fruit. Sometimes they are given sweetmeats to eat first and then dishes prepared with salt. They are

detained for at least one day. When they leave the bride's house on their return journey, they are given presents in money and sometimes suits of clothes. They are also given a plain ring (बहा *chhalla*), a red handkerchief, and some sweetmeats as presents for the bridegroom.

1367. *The letter of promise* बदा का बहा (وعدہ کا تمغہ) *wāda ka rukka*.—When the time of marriage approaches, the parties, either orally or in writing, fix a date for it. Afterwards a customary letter of promise is sent, written on red paper and sprinkled over with pieces of gold or silver leaf. The letter is to the effect that such and such a day has been fixed, and that the writer hopes that it will meet with approval. Amongst poor families, the letter is sent in a bag of red cloth or velvet, together with two betel-nuts, some green grass, one or two pieces of turmeric, and a little rice. Amongst rich families, the letter is sent in a silver or golden box. The box is placed inside an embroidered bag together with the betel-nuts, &c. The whole is sent on a silver plate. The letter is always carried by a barber, who is given a handsome present, consisting of cash, clothes, and utensils by the girl's guardian. The guardian sends a reply either through the same man or through a messenger of his own. A tailor is then sent by the girl's guardian to take the measure of the boy's dress. He also gets a present from the boy's people, on going away. The marriage must take place not more than two months after this correspondence.

1368. *The going into retirement of the bride and bridegroom* मायून (مأیون) *māyūn* or मांजा (مانجا) *mānjha*.—After the interchange of letters, the bride and bridegroom sit in *mānjha*.—The girl puts on a sheet dyed with safflower, and the women of the neighbourhood and her female relations assemble, and rub her with cosmetics (उबतन *ubtan*), singing songs as they do so. From that day the girl sits in a room, and never leaves it except for necessary purposes. She does not see the face of any man,—not even of her father or her brother. She eats only milk and fruits, and every day the barber's wife comes and applies cosmetic to her. In the meantime the boy is undergoing the same treatment. He wears similar dyed garments, is surrounded by females, and cosmetic is rubbed on his body every day. In South Munger he does not thus go into retirement.

1369. *The ceremony of the grindstone*—बहो *chakki*—and the washing of the pulse—दाह जोर (دال شوری) *dāl shoī* or दाह जोर *dāl dhoī*.

Two or three weeks before the marriage a grindstone is put in one of the rooms of the female apartments of both the houses, which has been previously well cleaned. The following day a number of women assemble and singing, accompany the maid-servants who carry some *mūng* (*phaseolus mungo*) to a well or river. Arrived there, they joke and sprinkle water on each other, while washing the grain. They then bring it back in the same way. It is dried in the sun, and ground into flour on the grindstone by seven women whose husbands are alive (बोहागिनि *sohāgini*). It is then made into a dish called बरौ *bari* for the ceremony of कंदूरी (کندوری) *kandūri* (see § 1377).

1370. *The cutting of the clothes.*—This is called कित्ता पारचा (قطع پارچه) *kita pārcha*, and takes place in the bridegroom's house. Men and women are invited, songs are sung, and the tailor cuts out the marriage dress of the bride. When it is cut, all the men present congratulate the boy's guardian, and give the tailor a small present.

1371. A similar ceremony takes place in the bride's house on the day of the marriage procession. There the bridegroom's wedding garment is prepared, and when it is being despatched to him the male friends of the family assemble under a canopy in the female quarters. A few stitches purposely left unfinished in the bridegroom's drawers are then completed by the tailor, who gets some small fees from those present. This ceremony is called चाऊ (or, in South Munger, जाना) बेचोतब (ساز بیوتنا) *sāj* (or *jāna*) *beatab*.

1372. *The vigil*—रतजग्गा *ratjagga*.—This ceremony takes place in the houses of both parties. A spot in the house is washed, and a small wooden stool is placed therein. A new water-pot is placed on it, and is covered over with a new earthen cover. A red handkerchief is then tied on it. A garland of flowers is then placed round the neck of the pot, sweetmeats are cooked, and hymns sung entreating God to bless the bride and bridegroom. The women sit up the whole night near the water-pot, thereby intending to keep God awake. At dawn the sweetmeats and रिहम (رحم) *riham** and *sharbat* are offered to God. They are then distributed among the people.

1373. *The erection of the canopy*—साबाबंदी (سایه بندی) *sāyā-bandī* or मँदूबा *mañrhuā*.—This takes place the day after the last ceremony. A canopy with four bamboo poles is erected in the female quarters. First, brown sugar is offered to the saint named *Shakarganj*, and then garlands are tied to each pole of the canopy. When the ropes of the canopy are being tied, the sister of the bride or bridegroom,

* Rice-flour mixed with clarified butter, sugar, and milk, and made into balls.

or any near female relation of the father of either, comes in and stops the work. The persons employed are not allowed to proceed till they have promised to pay her a sum of money. When the canopy has been safely erected, a paste of sandal powder is rubbed on the faces of those present. In some places, after the erection of the canopy, a goat or a cow is sacrificed in memory of the saint Shaikh Abdul Qadir Jilāni, (شیخ عبدالقادر جلانی). The flesh of the animal sacrificed is cooked on the spot where it was killed, with rice and gram, in new earthen pots. When cooked, it is offered in the name of the saint, and then eaten.

1374. The same night another ceremony takes place. A potter is ordered to make a small water-pot. This is coloured and painted with figures of horses and elephants. It is called कलसा *kalsa*. It is placed in the courtyard and covered with an earthen cover, on which ears of rice and mango leaves are put. A four-wicked lamp (चौमुख *chaumukh*) is kept burning on it every night. This pot is neither opened nor removed till the marriage ceremony is over. When it is first deposited, the women sing a song over it, the purport of which is, "We have shut up storm, rain, serpents, scorpions, and worms herein."

1375. On the same night another ceremony, called चिहाल तन (چهل تن) *chihal tan* (forty persons), takes place. A number of beggars who play the drum and fiddle are invited, and towards the end of the night a pit, four or five feet wide and two or three feet deep, is dug under the canopy. In this pit large billets of wood are burnt, while the beggars play and sing hymns in honour of the same. When the fire begins to burn brightly, they one by one fall upon it and extinguish it with their bare feet. Sometimes they carry the bridegroom in their arms while performing the ceremony. When it is over, fried gram and fried wheat mixed with sugar are offered to the forty saints.

1376. *The song of Balaimiyan.*—This is called पीर का नजा (پیر کا نجا) *pir ka naija*, or बाले मीयान (بالی میان) *bālai miyān*. Next day the females of the neighbourhood are invited; a spot is washed beneath the canopy, and the green branch of a mango tree with leaves on it (or sometimes simply a wooden stick 3 or 4 feet high) is erected therein. A red handkerchief dyed with safflower is spread over it. The women then sing the song of *Bālai Miyan*. At the same time an अंकीया *ankhiya** is put in a new earthen pot, offered to the saint, and then distributed to the people.

* A kind of cake made of wheat-flour and rice-flour and boiled in water. It is shaped like the eye, *ankhi*: hence its name.

1377. *Offering to deceased elders.*—This is called **कंदूरी** (کندوری) *kandūri* or **बीबी के सहाबक** (بی بی کی صحابک) *bibi ke sahnak*, and takes place on the same night as the last ceremony. An earthen fireplace (**चूल्हा** *chūlha*) is prepared at home and placed beneath the canopy. The maid-servants go singing to fetch water, carrying several water-pots covered with red cloth, and accompanied by musical instruments. They must be married women of good character; they may not be widows, or women who have married twice. In the water which they bring, rice, gram, *māng* (*phaseolus mungo*), fruits of the egg-plant, and pumpkins, &c., are cooked. When cooked, first the rice is distributed on earthen plates, then on it the pulse, then a little tyre prepared specially for the occasion, and then the vegetables and cakes. On each plate one betel-leaf and one garland is laid. In some places only rice, curds, and sugar, are put on the plate, and this is called **मिठी कंदूरी** *mīthi kandūri*. These plates are prepared in great number, and have been previously kept in a room washed for the purpose. Then the plates are offered, first one in the name of the prophet, then one in the name of his daughter *Bibi Fātma* (فاطمه), then one each in the names of many saints, and then one each in the names of the deceased members of the family, so far as they can be remembered. Great care is taken to make offerings in the name of all of the last. After this the females of the neighbourhood and those related to the family who have been invited assemble in a place in the courtyard (**बाँगन** *āngan*) of the house, which has been well washed for the occasion, and sing songs in the praise of *Bibi Fātma*, and eat the offerings. No woman who has been married twice, or who is unchaste, dare eat out of these sacred plates.

1378. *The anointing.*—**तेल चढ़ाव** *tel charhāḥ*.—This takes place in the houses of both the bride and bridegroom the day after the last ceremony. Each is made to kneel down on a wooden bench (**चौकी** *chauki*), and a yellow cloth is thrown over him or her. Then seven married women (**सोहागिनि** *sohāyini*) tie up seven cakes (**सुहाकी** *suhāki** and **पौठा** *pītha*) in a yellow handkerchief, and wave it round their heads. Then they anoint the whole body of the bride or bridegroom with oil. A small bundle is made up of mustard seeds tied up in a piece of yellow cloth, and then tied on the arm of the bride or bridegroom. This is called **कंगना बाँधन** *kangna bāndhab*.

* A cake made of flour and turmeric and fried in clarified butter.

1379. *The marriage procession.*—This is *बरियान bariyat*, &c., as amongst Hindus; see § 1290. When the time for the departure of the bridegroom's marriage procession draws near, the maid-servants of the bridegroom's house go out, singing songs, to fetch water. On their return they are stopped at the gate by the musicians, who refuse to let them pass till a present has been made to them. The water is placed under the canopy, where also a small stool is placed. The male members of the family assemble there, and, as songs are sung, the brother-in-law of the boy, or any near relative, digs a pit there. This is called 'digging a pond,' *पोखरा खोदव pokhra khodab*. He also gets a present for doing this. The bridegroom then bathes at this place, and puts on his wedding garments, consisting of (a) coloured drawers, (b) a kind of overcoat (*जामा (جاما) jama*) dyed with the safflower, or made of *प्रकरङ्गा ekranga* or of brocade (*असावरी (اساوری) asawari*), (c) a white turban covered with a red cloth, or a red turban, (d) a garland of flowers, and (e) a handkerchief carried in the hand. He then mounts on horseback, and visits first the grave of some saint, where he makes an offering of sweetmeats, and then the village *imāmbāra* (*इमामबाड़ा (اسام بادا)*),* where he makes a similar offering. He then starts for the bride's house, and on approaching it he pays similar visits to the tombs of saints and the *imāmbāra* there. In the meantime the bride has also bathed, put off her *मंजहा mānjha* dress, and put on another which has been prepared either in her own house or in that of a relative.

1380. When the time for the arrival of the bridegroom approaches, the bride's maid-servants set out on the road on which it will come, carrying with them rice soaked in water and a newly-made ladle (*दोड़ dōi*), to which is tied a piece of red cloth. They stop at a well or a river, lay the ladle down on the ground, and cross over it one by one, eating the rice as they do so. They then dig up a *चिरचिरा chirchira*† shrub which they had previously noted, and carry it home, singing songs. The root of the tree is ground up and made into pills, which are administered to the bridegroom on the night of the *जहवा jahwa* (§ 1384).

1381. *The sending of presents.*—This is called *साचक (ساقق) sāchak*. Before the arrival of the marriage procession a *बारी bari* is sent

* An *imāmbāra* is, according to Bihār tradition, a building erected in honour of the celebrated martyr Imām Hassan, the grandson of Muhammad.

† *Achyranthus aspera*, said to be of sovereign virtue to one bitten by a venomous reptile or stung by a scorpion, &c.

to the bride's house. This word has two meanings, viz. (1) a dish of cooked pulse, and (2) that here referred to,—all the following presents taken together. It consists of:—

- (1) Dresses for the bride, of from one to twenty-five suits. The first suit, or wedding dress (रौत के जोड़ा *rit ke jora*), is also called the शहाना (شاهانه) *shāhāna* or royal suit. It is not worn after the fourth day of the ceremony. It consists of a pair of long drawers of satin cloth and a जामा *jāma* (see above) of brocade, *tasār* silk, or पकरङ्गा *skranga*. A second suit, also of fine materials, for the fourth day is called the चौथी के जोड़ा *chauthi ke jora*; and a third suit, for the tenth day, दसहरा के जोड़ा *dasahra ke jora*. Each suit is of less value than the preceding one.
- (2) The chaplet, सिहरा (سیرا) *sihra*, for the bride.
- (3) Some raw thread dyed with safflower. This is called नाड़ा *nāra* or कल्लावा (کلاوا) *kalāwa*, and varies in amount from one or two *chhatānks* to a maund.
- (4) Some otto of spices, सोहाग के अतर (سوهاگ کا اطر) *sohāg ke atar*.
- (5) Sweet-scented oil.
- (6) A cone-shaped basket (called सोहाग पूरा *sohāg pūra*) of bamboo, covered with red paper and containing चहलचहबेला *chhalchhabela*, नगर मोथा *nagar motha*, बाबु बड़ *bāl chhar*, the bark of the bay-tree (तज *taj*), cardamoms, sandal-wood, grains of musk, nutmeg, mace, saffron, cassia, turmeric, &c.
- (7) Sweetmeats.
- (8) Fruits, viz. almonds, pistachios, grapes, dates, cocoa-nut kernel, &c.
- (9) Spices for betel.
- (10) Fifty-two water-pots. These are small in size and are gaily coloured. In each a little rice, some betel-nuts, and some mango-leaves, are put.

These things are carried on the heads of maid-servants in procession in trays, accompanied by torches, music, and fireworks. First comes a large tray carrying the royal robes, then small trays, on each of which is placed another suit, and then the rest. The whole is covered by a long piece of cloth called दलहकना *dalhakhna*.

1382 In the meantime the bridegroom's dress is despatched from the bride's house, with a tailor, to meet the procession. The dress consists of a red **जामा** *jāma* (see above), long drawers of silk often worked with gold and silver flowers, a turban covered with a red handkerchief on which is laid a garland, and over this a very thin handkerchief, called **मग्ना** (مقنا) *magna* or veil, and a red handkerchief for him to carry in his hand. When the bridegroom is clothed in this by the tailor, he gives the clothes in which he has travelled so far to the barber, who follows the bridegroom, carrying an umbrella over his head. Then the ceremony of **निकाह** (نكاح) *nikāh* or religious marriage is performed, and dates and sweetmeats distributed to the assembled guests.

1383. After this the bridegroom goes on horseback to the bride's house with great pomp, accompanied by a large party of men with torches, fireworks, and music. When they reach the house, all the men remain standing outside, while the bridegroom enters the female quarters of the house either on foot or horseback. There he sits on a wooden stool (which is given him in dowry), and his mother-in-law (or if she be dead, some other female relation of the bride) comes to him carrying a plate containing a small lamp made of flour and a little **अरुवा** *arua* rice. She warms her hand at the lamp, and then touches the cheek of the bridegroom. While she is doing this, a woman comes and whispers in his ear the following Hindi verse "सोने में सोचागा, खर में तागा। सो दुसन्दा का मन दुसन्दिन वै जागा।" *some men sohāga, sūi men tāga o dulha ka man, dulhin se lāga, i.e., borax* in gold, a thread in a needle, and the bridegroom fell in love with the bride."* Then six married females (**सोचागिनि** *sohāgini*) and the mother-in-law alternately touch the cheeks of the bridegroom with the **अरुवा** *arua* rice. He is then given some *sharbat* to drink. This is prepared in various ways: sometimes the wet hair of the bride after she has bathed is dipped into it, sometimes a small piece of sugar is put into her hand till it becomes moist with the perspiration, and then the *sharbat* is made of it, and sometimes it is made of a piece of sugar which she has taken into her mouth and crushed between her teeth. Then the bridegroom stands on the wooden stool, and a maid-servant carries in the bride in her arms, and touches the back of the bridegroom with her feet, and takes her away: then the bridegroom returns to his own party.

* Borax is a flux for melting gold.

1384. The *जलवा jalwa*.—The day after the arrival of the procession, milk, a dish called *मलीदा* (مالیڈا) *malida* or sweetmeats, and *sharbat*, are sent from the house of the bride to the bridegroom's party. The *मलीदा malida* or sweetmeats are put into the milk and drunk by the bridegroom out of a cup of silver or copper, which is given to him afterwards in dowry. Then the others drink it. The same evening maid-servants come from the bride's house singing songs, and take away the procession umbrella, and under its shade seven married females grind the spices which came in the *सोहाग पूरा sohāg pūra*, and when ground, apply the powder to the hair of the bride, which they also tie with the *नारा nāra* or string which came at the same time. The scented oil is also applied to her hair. Then the bride puts on the royal dress, a garland of flowers, the chaplet *सिहरा* (سیہرا) *sihra*, and a veil, which is thrown over her face. She takes off all the ornaments of her maidenhood, and puts on new ornaments sent her by the guardians of the bridegroom. Black powder (*मिस्री missi*) is applied to her teeth, and she is adorned in every other practicable way. During the day, it may be added, myrtle leaves have been applied to the soles of her feet to make them red. When she is ready, the bridegroom is sent for, and he comes walking, preceded by a maid-servant walking backwards, and carrying a plate on which is a burning lamp, so arranged that the smoke is thrown towards the bridegroom. When he reaches the gate of the female quarter of the house, the mother of the bride, or (if she is dead or a widow) any other married woman, meets him, and conducts him inside. The manner of doing this varies in different places. Sometimes the mother carries in her hand a plate in which lamps made of flour or silver are burning, and the wicks of which are of red cloth. A small quantity of the red thread (*नारा nāra*) already mentioned is also laid on the plate. She walks backwards with her face towards him, and at every step throws down a piece of thread, and asks the bridegroom to pick it up and lay it on the plate. In this way, and at the same time touching his cheeks with her hand warmed at the lamp, she takes him into the inner yard, under the canopy. In other places the mother-in-law gives him betel to chew, which he bites and throws away.

1385. When the bridegroom comes under the canopy he sits on a wooden stool near a bed. As long as he stays there his sister (or, in her absence, a maid-servant) spreads a portion of her cloth (*सारी sārī*) over his head. Then the match-maker (*मुशहता* (موشهتا) *mushhata*) throws a string round his neck, and pulling it gently, refuses to

let it go till she is paid something. A cloth is then hung between the bed and the stool, and the match-maker (who has also had charge of adorning the bride) makes her stand on the bed in such a way that the bridegroom can only see her face. She then places the two hands of the bride on her (the bride's) forehead, and moves the bride's head this way and that way. A coloured handkerchief, in which is tied rice and turmeric, is then given to the bridegroom, who throws it on the bride, and each time he does so he is given a betel leaf in which pieces of the root of the चिरचिरा *chirchira* shrub already mentioned are wrapped up. This moving of the head and throwing of the handkerchief is repeated seven times, and the ceremony is called जहाजा देव (جلو دینا) *jahaja deb*. The bridegroom then sits on the head of the bed, and the match-maker takes off the chaplet and veil from the face of the bride and shows it to the bridegroom, who for this favour gives her a present, and at the same time receives presents from the female relations of the bride. Sometimes, after this is done, a cup containing sandal-wood and a finger-ring of silver, which has a small cup made in the place where there is usually a stone, is given to the bridegroom, who, after dipping the ring into the sandal-wood, touches the forehead of the bride with it. In other places vermilion (बिन्दु *senur*) is used instead of sandal-wood.

1386. Then the wife of the bride's brother, *i.e.*, the bridegroom's सरहज (سرهج) *sarhaj*, comes and sits on the bed, and throws little balls of flour at the bridegroom, who does the same to her. This ceremony is called गेंद खेलव *gend khelab*. A maid-servant then carries off the bride in her arms, followed by the bridegroom, who catches hold either of a corner of the bride's sheet (बदर *chaddar*) or her finger.

1387. It must be noted that throughout all these ceremonies the bride has kept her eyes shut, and never moves on foot, but is always carried in the arms of a maid-servant.

1388. The bride and bridegroom are then made to stand in an outer room (दालान *dalan*), and in the hands of both a little rice is put, but the hand of the bride is turned backwards. They are then caused to toss their hands up in the air, by a maid-servant, and thus the rice is scattered through the house, and the bride says at the same time that she is filling the house of her father and mother. The bridegroom also says that he is filling the house of his father and mother-in-law. This ceremony is called घर भरव *ghar bharab*. The bride is then carried

off to a well-furnished room, where the bridegroom takes off her shoes with his own hands.

1389. *The departure of the procession.*—This is *रुक़्खती* (رخشلی) *ruk̄k̄hātī*, and takes place on the third day after the above-mentioned ceremony. The bridegroom is called into the female apartments, and he and the bride are given rice-milk *चौर* (*khīr*) to eat. He affects displeasure, and refuses to eat with her. The mother then makes him a present, and he consents to do so. Then the bride and the bridegroom sit together on a carpet, and a small piece of sugar on a betel-leaf is placed first on her head, then on her shoulder, then on the palm of her hand, then on her knees, and lastly on her feet. The bridegroom is pressed to pick up the pieces of sugar from each place with his mouth, or at least with his hands. This ceremony is called *नबत चुनब* *nabāt chūnab*.

1390. When the bridegroom goes off to his own house with the bride, she is carried in the arms of a maid-servant, and keeps her eyes shut till she reaches the court-yard of her husband's house. The sister of the bridegroom first meets her with a jug of water and washes her feet in a plate, which she (the sister) keeps as her perquisite. After this the ceremonies of *घर भरब* *ghar bharab* and *नबत चुनब* *nabāt chūnab* are performed again in the bridegroom's house.

1391. *The ceremony of the fourth day.*—This is *चौथी* *chauthī* or *चौथारी* *chauthāri*. It takes place on the fourth day after marriage, *i.e.* on the day after the arrival of the bride and bridegroom at the latter's house. The bridegroom takes off the thread *नारा* *nāra* with which the hair of the bride had been tied. The women of the family then bathe the bride in the female apartments, singing songs at the same time, and the bridegroom himself bathes outside. Sometimes the bridegroom also bathes inside. The bride then puts on her dress made for this day (see § 1381), and the bridegroom also puts on the dress given him by his father-in-law. The bridegroom then enters the female apartment, and joins in the ceremony of *जूबा* *jūa*, or gambling. Seven spotted shells (*चिन्नी कौड़ी* *chitti kauri*) and a necklace (*चन्दन हार* *chandan hār*) are thrown up in the air. A maid-servant extends the bride's hands, and the bridegroom his own, and both try to catch the falling necklace. The one who succeeds wins the game.

1392. Two or three days after the arrival of the bride in the bridegroom's house people come from her house to take her back. The bride's

younger brother and other relations may form some of the party, but not elders, such as the father or uncles. They bring with them presents of sweetmeats, rice, pulse, a goat, &c., varying in quantity according to means. Two or three days afterwards they return with the bride and bridegroom.

1393. *The ten days' stay.*—This time the bridegroom stays nine or ten days in his father-in-law's house. This stay is called the दसवारा चात *dasahra khāna*. On their arrival a room is made over to the bridegroom in the female apartments, and the bride is made to walk into this room accompanied by her female relatives and those of her husband, all singing songs. This is the first time the bride is allowed to walk since the commencement of the ceremonies. Up to this she has been always carried about. When the bride approaches the bridegroom in this room, he is expected to salute (सलाम *salām*) her. If he does not do so, showers of abuse are poured upon him.

This concludes the wedding ceremonies.

CHAPTER V.—BIRTH CUSTOMS GENERALLY.

1394. An adopted child is amongst Musalmāns मोतम्मन्ना (متمنن) *motmanna*. Amongst Hindus he is पादक *pālak*, पोसपुत्र *posput*, or पोसपादक *pospālak*. Local names are पोसबेटा *posbeta* or पोसबालक *posbālak* in the south-east, and कर्ता पुत्र *karta putr* in East Tirhut. To adopt a child is पोसिया लेब *posiya leb*, गोद लेब *god leb*, or रास पर लेब *rās par leb*.

1395. When a woman cannot suckle her child, owing to pains in and hardness of the breast, she is called थनेलियाही *thanailiyāhi*. Inability to suckle on this account is थनेली *thanaili*. When a child is not well nurtured owing to the untimely death of its mother, or to her milk running dry, it is called दुधदहवा *dudhtutua* or दुधकदवा *dudhkatua*. In South Bhagalpur it is कहरा *kāra*.

1396. A seven-months' child is सतन्वास *satwāns* or सतन्वास *satwānsa* generally; also सतन्वास *satwānsu* south of the Ganges, सतन्वास *satmās* in North-East Tirhut, and सतन्वास *satmasua* in South-East Tirhut and South Bhagalpur. An eight-months' child is अठन्वास *athwāns* generally; also अठन्वास *athwānsu* south of the Ganges, अठन्वास *athmās* in North-East Tirhut, and अठन्वास *athmasua* in South Bhagalpur.

1397. An only child is प्रकलौता *eklauta*; also प्रकलुहा *ekáhula* in Shahabad and प्रकौनिषाँ *ekauniyañ* in South Bhagalpur. A first-born child is पहिलौठा *pahilautha*. The youngest child, *i.e.*, the last which a woman has, is called पेट्पोँकुचा *petponchhua* or कोरपोँकुचा *korponchhua*. When a girl is born after three boys (which is considered very lucky), she is called a तेतर *tetar*, and she is even often named तेतरौ *tetri*. In the south-east, however, a girl born after two and not after three boys is so called. A child whose elder brother is dead is called मराच *marāchh*, or मरचवा *marachhwa*, or (in South Bhagalpur) मरोचा *marochha*, and (in North-East Tirhut) मचई *machhai*. Such children are treated and dressed as girls, sold to the midwife for a few cowries, and brought back again and given opprobrious names, in order to induce the demon of death to think them of small account and not worth killing.

1398. When a woman has a child every year she is बरसाएन *barsāin*, or in South Bhagalpur बरसैनी *barsaino*. A woman with only one child is प्रकौज *ekaunj*, or to the east काक बन्हा *kāk banjha*, or कौचा बाँज *kaua bānjh*. The latter name is said to be derived from the children's game of काग दुरस *kāg durus*, or "odd or even." In this game one boy guesses whether another has an odd or even number of cowries in his hand. If he guesses an odd number he says काग *kāg*, or if an even one दुरस *durus*. Hence काग *kāg* means an odd number, and specially 'one.' A barren woman is बाँज *bānjh*, बाँज पहिलुहा *bānjh bahila*, or (in the south-west) बाँजिन *bānjhin*. A woman after delivery, until the purificatory ceremonies are performed, is अलवन्ती *alwānti* or परसौती *parsauti*. The lying-in room is north of the Ganges सोरौरी *soiri*, and to the east also सोएर *soer*. South of the Ganges it is सौर *saur*, सौरौ *sauri*, or जचचा खाना *jachcha khāna*. In this a fire is kept burning for ten days after the woman's delivery. This fire is known to the north-east as अगियासी *agiyāsi*, and in South Bhagalpur as पोड़ा *pora*. Elsewhere it is पसंगी *pāsanghi*, with a variant पसंगी *pāsangi* in the south-west and in South Munger.

1399. The presents given to a woman in a state of pregnancy are known as सधोर *sadhōr*. In South Bhagalpur such presents are given after delivery, and are called सधोरा *sathōra*. अचह्वानी *achhwāni* is caudle given to a lying-in woman to produce milk. It is also called सोठोर *sothaur* in the north-east and सोठोरा *sothaura* in Gaya and the south-west. Another name current in the north-east is

अधरसी *adhrassi*; in South Munger it is कदवा *kadwa*, and in South Bhagalpur चारो दूड़ *ādo gār*. The longing of a pregnant woman is दोहर *dohad* or मन्चलब *manchalab*. The earthen cakes which she is fond of eating when in this condition are called अधरु *khapra*.

CHAPTER VI.—CEREMONIES PECULIAR TO THE BIRTH OF A HINDU CHILD.

1400. When the labour pains commence, the चमारि *chamāri* or चमैनी *chamaini*, i.e. the native midwife, is sent for. She is also called दगरिब or दगरिब *dagrib*. On her arrival she puts a finger-mark (टीका *tika*) of vermilion on the wall. This ceremony is called सोरारी *sorāri*, and is supposed to hasten the delivery of the child. As soon as the child is born, the midwife washes the forelock (लट *lat*) and feet (गोर *gor*) of the mother, which operations are called लटधोषार *latdhoṣār* and गोरधोषार *gordhoṣār* respectively. She gets a fee (नेग *neg*) for doing this. The child's navel-string (नार *nār*) is then cut. If the child is a मराच *marāchh* (or मरचवा *marachhwa*), i.e. if the child which was born before it from the same mother is dead, the navel-string is all thrown away. Otherwise it is buried in the floor of the lying-in room, and over it the fire (पसंघी *pāsaṅghī*) is placed. The latter is called in South Bhagalpur पसनी *pasni* or घूर *ghūr*. The child's body is then rubbed with कोठवार *kothwār*, which is the dust of a sun-dried granary (कोठी *kothi*), in order to take off the foetal excretion (जावर *jāwar* or जाँवर *jāmwar*). The midwife's fee for cutting the navel-string is नारकटार *nārkatai* or नरकटार *narkatai*.

1401. When the child's body has been thus rubbed with dust, it is bathed in lukewarm water, and then the midwife throws it up in the air and catches it again five times. This is called लरिका लोकाग्र *larika lokāgr*. At the same time another woman strikes a brass dish (थारी *thāri* bajāēb), and the mother holds in her hand a handful (अंजुरी *anjuri*) of grain, which last is the perquisite of the midwife. The after-birth (लिहरी *lijhri* or नार पुरैन *nār purain*),* &c., is then thrown away in a vessel called खप्रौर *khapraur* or (in Gaya) खप्रौरि *khaprauri*, for which the midwife receives a fee called खप्रौर पैकार *khapraur phenkāi*.

1402. Two or three days after the birth, when the पन्नेहित *prohit* or family priest has fixed on a lucky day, the ceremony of मचाव

* The after-birth of an animal, as distinguished from that of a human being, is नर *jhar* or नार *jhār*.

nahāwan is performed. This consists in नीम *nīm* (*azadirachta Indica*) leaves being boiled in water, and both the mother and child being bathed with the decoction. Then a handful of seeds of राई *rāi* (mustard, *sinapis racemosa*) and जैवंदीन *jeñwāñin* (dill, *ligusticum ajowan*) is waved (निहावर करव *nichhāwar karab* or चींख *aunchhab*) round the mother's head and thrown into an earthen cup containing fire. When the seeds are consumed, the cup is upset, and the mother breaks it with her left foot. Then she sits with grain in her hand, while the brass dish is again beaten, and the midwife again throws the child five times in the air. This all takes place in the court-yard of the house, and is done to avert the evil eye. It is the first day on which the mother comes out of the lying-in chamber. The same day this chamber is plastered over with fresh mud, amongst the rich by a maid-servant, and amongst the lower classes by the husband's sister ननद (*nanad*), who gets a fee for this, called सोररी खिपार *soiri lipāi* or (south of the Ganges) सौर खिपार *saur lipāi*. The same day the washerman takes away the lying-in clothes (छुतका के कपड़ा *chhutka ke kapra*), and washes them. His fee for this is called छुतका *chhutka*.*

1403. The next day after bathing, the barber pares the mother's nails, which ceremony is called नोचन्दङ्गी *nohtungi* or नचन्दङ्गी *nahtungi*, and his fee is known as नोचन्दुंगार *nohtungāi*.

1404. On the seventh or eighth day, when the mother is first able to eat rice, the ceremony of खेंदी जोड़ावन *kheñdi jorāñb* is performed. A hole is dug in the ground, into which milk and water are poured. The mother sits close to it, and eats her first dish of cooked rice. From this day collyrium (काजर *kājar*) is put on the child's eyes. Before this, when oil was rubbed on the child's body, the child had been laid on its back during the operation, but henceforward it is laid on its face for the application. From this day, also, the mother gets a bed to sleep on. Up to this day she had been fed only on caudle and on a mixture of oil, turmeric, and molasses (परहदी गूर *hardi gūr*).

1405. On the twelfth day the ceremonies of हॉनी काँकव *donni jhānkab* and चठो *chhathi* are performed. Sometimes the latter ceremony is omitted. In the former, five दोनी *doni* or दोना *dona*, which are a kind of platter, are prepared of leaves of the jack-tree (कठवर *kathar*). In these cakes (पूरी *pūri*), rice milk (खीर *khīr*), &c., are placed. Sometimes the leaf platters are omitted, and rice milk, &c., is simply laid

* The washerman caste is considered an unclean one because its members touch these garments.

on the ground over the cakes. Worship is then performed, and the articles eaten.

1406. The चढी *chhathi* or चढी *chhatthi* ceremony is also called in Tirhut चढियार *chhathiyār* or चढि *chhathi*. As its name indicates, it should properly be performed on the sixth day after birth, but this rarely occurs now-a-days. When it is held on the twelfth day it is also called बरन्ची *barhi*. In this ceremony a kind of square marked with diagonals and made of cowdung is fastened on the wall. At every corner and intersection cowries are fastened, and the whole is painted with vermilion, and cakes, &c., are laid before it. The child is then oiled, has collyrium applied to its eyes, is wrapped up in a cloth, and placed before it. It is then dressed in new clothes, and rings (चङ्गा *kara*) are put upon its arms and feet for the first time, and some money put into its hand. On this day also the child is named, and the relatives are fed.

1407. The ceremony of purification performed on the fortieth day after birth is called चिहा *chhilla*. In South Munger a similar ceremony takes place on the twentieth day, and is called बसदौरी *basdauri*. The ceremony of first feeding the child with rice is called अन्नप्राशन *anprāsan*, also (south of the Ganges) खिरचिहार *khirkhiyāi* and खिरचहार *khirchatāi*. In Gaya it is निमक चढी *nimak chasi*, and in South Munger चढावन *chatawan*.

CHAPTER VII.—BIRTH CUSTOMS AMONGST MUSALMĀNS.

1408. The navel string (नार *nār*) is cut by a चमैनी *chamaini*, and the child is then bathed गोसल कराब (غسل کرنا) *gosal karāeb*. Sweetmeats are then consecrated (निवाज करब (نیاज کرنا) *niyāj karab*) in the court-yard by the male members of the family, and the milk of a respectable and virtuous woman is given to the child in a shell (सितुहा *situha*). This ceremony is called दुधपिलार *dudhpilāi*. The people are then called to prayers by striking a brass pan (धारी *thāri*) with a stick, and this custom is called बन सलवात (بن سلاوات) *ban salwāt*. In South Munger it is called बाँग सलवात *bāng salwāt*.

1409. The lying-in room, in which the mother (परन्सौनी *parsauti*) is, is always kept warm with an अंगेठी *angethi* or moveable stove, and is called सौरी *sauri*, &c.; see § 1398. Caudle (अचनानी *achhuanī*) is given to her to produce milk, and oil mixed with turmeric and molasses is given to her to make her strong. This last mixture is called बरन्दी दूर *hardi*

gār. Until milk flows in the mother's breasts, the child is wet-nursed with the milk of the woman whose milk was given to it immediately after it was born.

1410. On the third day the mother and the child are bathed and dressed in new clothes, and the women of the neighbourhood come and sing songs, and receive oil and vermilion. Up to this the mother has had nothing to eat except the caudle and the mixture already mentioned, but now she is allowed to eat food and to sleep on a bed.

1411. On the same day the washerman takes away the lying-in garments, and the barber pares the mother's nails and shaves the child. The former operation is called नखदहणी *nahtungi*, and the latter बाळ तराशी (بال تراشي) *bāl tarāshi*.

1412. The fees of the midwife (चमैनी *chamaini*), of the washerman, and of the barber, are all known as परमाँनी के कामार *parsauni ke kamāi*.

1413. On the same day the lying-in room is plastered over with mud plaster. This operation is known as सोपर चिपार *soer lipāi*.

1414. On the fortieth day the consecration ceremony (निवाज (نیاज) *niyāj*) is again performed, and the relations are fed.

1415. Circumcision is खतना *khatna* or सुन्नत *sunnat*. See also § 386.

CHAPTER VIII. — DISPOSAL OF THE DEAD AMONGST THE HINDUS.

1416. The burning of a corpse is दाह देव *dāh deb*, चात्रि देव *āgi deb*, दग्ध करव *dagadh karab*, or जारव *jārab*. In North-East Tirhut it is also संस्कार देव *sanskār deb*, and in the south-east जराद्व *jarādv*. When a Hindu dies he is taken out of the house and placed on a bier. A bier is रन्धी *ranthi* generally; also टिकठी *tikthi* in South-West Shahabad, ताटी *tāti* in the east generally, डाठ *dhāth* in North-East Tirhut, फर्की *pharki* in South-East Tirhut, and चचरी *chachri* in South Bhagalpur. Sometimes he is simply placed on a bed (चरपाई *charpāi* or खटिया *khatiya*). Four men, who are called मजिह के जानिहार *majil le jānihār*, or in South Bhagalpur कंकथिया *kankathiya*, carry the bier on their shoulders and set it down on the ground outside the village. This is called नगर बिसर्गाव *nagra bisrāw* and is done in order that the people who are to accompany the corpse (who are called मजिहिहा *majiliha*) may collect.

1417. After the departure of the corpse from the house the walls of the latter are plastered over with fresh plaster, and outside it are placed a stone, cowdung, iron, fire, and water for the *बजिबिवा majikha* to touch on their return from the cremation.

1418. The four men who carried the bier take it on, when the people have collected, to the place of cremation on the bank of a river. This place is called *असमान asmasān*, or *मुरधहती murdhatti* north of the Ganges. In North-East Tirhut it is *समसान samsān*. South of the Ganges it is *चिरार chirār* or *चिरारी chirāri*, or to the South-East *मरघहती marghatti* or *मुरघहिया murghatiya*. In East Tirhut it is also called *मरघह marghat* or *मुरघहती murghatti*. They then bathe the corpse (*नहनाएव nahwāëb* or *असनाएव asnān karāëb*). The heir or chief mourner (*करना karta*) then has his head, beard, and moustaches shaved (*भद्र करएव bhadr karāëb*), and puts on a dress of mourning (*उत्री utri* or *कपनी kaphni*). He then dresses the corpse in new clothes, viz. a waist-cloth (*कच्छा kachchha*) and a sheet, washes its mouth, and then with the assistance of the other men places it on the funeral pile. To dress a corpse in this way is *कपनाएव kaphnāëb*.

1419. A funeral pile is *चिता chita* generally, also *चैती chaiti* in Gaya and *सारा sara* in Patna and the south-east. To prepare it a trench is dug in the form of a cross and four pointed logs (*खूंडा khūnda*) are driven into the ground at each end, and between them the logs of wood are piled. When the corpse is placed on the pile, the chief mourner (*करना karta*) anoints its mouth with a mixture of *गुग्गुल gugul* (gum of the *amyris agallocha*), barley, incense (*धूप dhūp*), water-nut (*मखाना makhāna*), honey, sesamum, and sweetmeats. He then buys fire (*आगि मोल लेब āgi mol leb*) from a *डोम Dom* (some, however, take fire from the house), and with it lights a long torch (*लूका lūka*). He then walks round the corpse five times, touches its lips each time with fire (*पचकरमा pachkarma*), and sets fire to the pile (*दगध करब dagadh karab*). When the body is nearly burnt, each of the persons present throws five sticks into the fire. These are known as *पचकठिया pachkathiya* north of the Ganges; in Gaya and the south-west they are *पंचआगि panchāgi* or *पंचआगिन panchagin*; in Patna they are *पंचलकरी panchlakri*; and in the south-east as *पचकठ पचकथी pachkath* or *पचकठि पचकथी pachkathi*. When the body is nearly all consumed, the fire is put out (*पानि देब pāni deb*) with handfuls of water, and the remaining small unburnt portion is thrown into the river for fishes and tortoises (*मचकच्छ या machhkachh la*). They then wash the place where the body

was burnt, and the chief mourner (करन्ता *karta*) plants a *tulsi* tree near by, and writes on the ground the words राम राम *rām rām*.

1420. They then bathe at another landing-place (घाट *ghāt*) and sit down. Then the करन्ता *karta* gets up first and walks towards home, followed by the others. When they arrive at the door of the house, they touch the stone, cowdung, iron, fire, and water already mentioned, and then their left ears, each with the little finger of his left hand. This ceremony is called कान काठी उतारव *kān kāthi utārab*. They then separate. Some castes, however, instead of performing this ceremony, simply bite a piece of bitter *nim* leaf, and then go home.

1421. Offerings are sometimes made to the manes at the time of cremation, and these are called in South Tirhut अस्मान पूजा *asmasān pūja*, or पंचपिन्डा *panchpinda*.

1422. The day after the funeral the करन्ता *karta* goes to the place of cremation, and pours on the site of the pile a little fresh milk. This is called चिता सेराव *chita seraëb*. He then comes to the village *pipal* tree, where he finds the barber and the family priest (परोहित *prohit*) waiting for him. The former has some fresh milk, and an earthen vessel (कंठिया *kantiya*) carried in a sling (सिक्खर *sikhar*) of मूँज *mūnj* rope. There is a hole in the bottom of the pot, partially stopped up with a plug. The *karta* hangs this up on a branch of the tree, so that its contents will drip out through the hole on to the root. He then fills it with milk and water and covers the vessel with an earthen cup (धकनी *dhakni*). He then goes round the tree three times, and goes home. The whole of this ceremony is called घण्ट टाँगव *ghant tāngab*. On reaching home he feeds his relatives with rice-milk and *urid* pulse, and himself eats off a potsherd (खपरौ *khapri*). Before commencing to eat, each person places a small quantity of rice and milk from his platter (पत्ता *pattal*) apart on another platter. This is called रूध कारव *rudh kārhab*, and the whole ceremony is called दुधमुँह *dudhmuñh* or दुधमुँही *dudhmuñhi*, and also दुधी *dudhi* in South-East Tirhut.

1423. The same evening and every evening up to the tenth day (दसवॉ *dasvān*) after the death, the करन्ता *karta* lights a lamp made of mud and placed on the top of a stick. The first day it is placed at the spot where the deceased died. The second day at a little distance from it, towards the door. The third day further off again, and so on, it being arranged that on the evening of the tenth day it reaches the spot outside the door where the five articles (stone, cowdung, iron, fire, and water) were placed.

This rite is called *दीया बत्ती* *diya bāti*, or (in East Tirhut) *सुख राति* *sukh rāti*, and in Patna *चिराग बत्ती* *chirāg batti*. Up to the tenth day the *करना* *karta* every day after bathing throws into the river or the well a handful of sesamum (*तिल* *tīl*) mixed with rice and water. This is called *तिलान्जुर देव* *tīlānjur deb*.

1424. On the third day after the death the rite of *तिराती* *tirāti* is performed, and in South-East Tirhut, on the fourth day, the *अथसञ्चन* *athsanchan*. On the seventh day is performed the *सप्तमहापत्र* *sapmahaṭṭr*. In this the male members of the family touch oil and oil-cake (*खरी* *khari*), and then bathe. When they return, the females do the same, and on their return to the house they put oil and vermilion on their heads, and a little gram soaked in water (*अकुरी* *akuri*) is given to each.

1425. On the tenth day is performed the rite of *दसकरन्ध* *das karm*, also called *दसवर्ष* *dasvān*, and in Tirhut *दसगात्र* *dasgātr*, and in North-West Tirhut *दसाही* *dasāhi*. On this occasion the male relatives shave their heads, and those who are sons of the deceased their moustaches also. Then the Brāhman who performs such obsequies, and who is called *कन्ताहा* *kantāha* or *महाब्रह्म* *mahābṛhman*, comes, and performs the ceremony of making obsequial offerings *पिन्दा परापत्र* *pinda parāṭṭr*. If the deceased is a male, this Brāhman gets as a fee all the requirements of a man (clothes, bed, shoes, umbrella, fan, dishes, lota, &c.), and, if a woman, all those of a woman. On the eleventh day offerings (*पिन्दा* *pinda*) are again made.

1426. Brāhmins are then feasted. This is called *ब्रह्मभोज* *brambhoj*, *भोज* *bhoj*, or *कारज* *kāraj*. Amongst Brāhmins this takes place on the 13th day after the death, amongst Rajpūts on the 14th day, amongst Vaisyas and amongst some Sūdras on the 16th day, and amongst other Sūdras after the expiry of a month. The ceremony is as follows:—In the day-time, the *परौषित* *prohit* or family priest performs the *पिन्दा* *pinda* ceremony, and after it the *करना* *karta* sits on a square marked on the ground (*चौका* *chauka*). A new turban is tied round his head, and he is dressed in new clothes. This is called *पगरी* *pagri* *banhāṭṭr*. The relatives also put into his hand an offering of money, called *नेता* *neota*. Brāhmins are then fed (*ब्रह्मज* *brāhman jeonār*). Afterwards, in the evening, the caste brotherhood are fed. On this day the widow of the deceased is clothed in her widow garments, which are known as *रान्सार* *rañr sari*, or (in Tirhut) *रान्सार* *rañrsār*. Amongst the upper castes this is a white cloth, but amongst the lower ones it is a coloured one.

1427. In the case of the death of a male, पिण्डा *pinda* ceremonies are performed six months and a year after death: the first is called चमासी *chhamāsi*, and the second बरखी *barkhi*. When, however, a marriage has to be celebrated in the family, the ceremony is performed three months after death, and is called तिनपखी के पिण्डा *tinpakhi ke pinda*. On all these occasions also Brāhmins and the caste brotherhood are fed.

1428. When all the funeral ceremonies have been performed in the orthodox way, they are called किरिया करम *kiriya karm*. When the body is merely thrown into a running stream, it is called परवाह *parwāh* or जलपरवाह *jalparwāh*. On five days in the month a body must be burnt with five effigies of कुस *kus* grass (*poa cynosuroides*). These images are known as कुसपुत्र *kusputr*, and the days as पंचक *panchak* or पचका *pachka*. In the south-east they are पचक *pachchak*. The visit of the women to condole after a death is मुंह देख *muñh dekh*, पुहारो *puchhāri*, or पुहारो *puchhāro*.

1429. Some Hindu and semi-Hindu sects and castes bury their dead. The principal of these are *Kabirhas* (कबिरहा *kabirha*), Saiva mendicants (अतीथ *atith* or सन््यासी *sanyāsi*), Sib Nārains (सिब नारैनी *sib nārains*), and *Mushars* (मुसहर *mushar*). To be buried is समाधि (or समाध) लेव *samādhi* (or *samādh*) *leb*, and to bury is मिट्टी देव *mitti deb* or समाध में बेसाग्रव *samādh meñ baisāëb*. The body is bathed and dressed in new clothes, the necklace (कण्ठी *kanthi*) and sectarian mark (तिलक *tilak*) are put on his neck and forehead respectively, and he is seated in the grave facing the north with the feet crossed under the buttocks (पलथी बैसव *palthi baisab*) and with cakes in his hand.

CHAPTER IX.—DISPOSAL OF THE DEAD AMONGST MUSALMĀNS.

1430. The corpse immediately after death is taken out into the verandah (बागवान *sāebān*) or court-yard (आँगन *āngan*). It is stripped and a new waist-cloth (लुंगी *lūngi* or लुङ्गी *lungi*) is put on it. It is then washed (गोसल कराग्रव (غسل کرانا) *gosal karāëb*). The man who washes has a kind of bag (called साफी (صافی) *sāfi*) on his hand, with which he wipes the corpse. He then performs the ceremonial ablution of the corpse (बजू कराग्रव (وضو کرانا) *waju karāëb*). This consists in cleaning its teeth, washing its hands, inside of the mouth, forehead, face, arms, and feet. He then dries it with a clean

चाद्री (صابوني) *sāfi*. The waist-cloth is then taken off as unclean, and is given to the barber, who attends to call the relations, and, when they are assembled, to look after their refreshment. A fresh waist-cloth is then put upon the corpse. Amongst the *Sunnis* this washing is generally done by friends of the deceased, but amongst *Shias* there is a special class of men who perform this work. The water with which the corpse is washed has been boiled with leaves of the बैर *bair* tree (*sisyphus jujuba*), and to this plain water is added. This washing is said to preserve the corpse from decay for a short time.

1431. A sheet is now taken, and a hole torn in the middle, through which the head of the corpse is put. The rest of the sheet hangs down before and behind. It is called झूल *jhūl* or कफनी (كفني) *kaphni*. The corpse is then laid on a bed (चारपार *chārpāi*), decently covered with a sheet, and taken to the grave-yard, which is known as कबरिस्तान (قبرستان) *kabristan*. The funeral itself is called जनाजा (جنازة) *janāja*. The prayers recited at the grave-yard or in the yard of a neighbouring mosque differ for men, women, and children. After their recitation the corpse is laid in the grave with the head northwards. The grave is then roofed over with bamboos or planks, over which some thatching grass (जहास *jhalās*) is laid, which is plastered over with mud. It is then filled up with dried earth, every member of the funeral procession assisting in doing so. This is called मिट्टी देव *mitti deb*. Before the party leave the grave-yard, alms (खैरात *khairāt*) are given to beggars. The man who digs the grave is a बोनियाँ *boniyān*, and his fee is known as कबर खोदाई (قبر کھودایی) *kabr khodāi*.

1432. For four days after the death nothing is cooked in the deceased's house, and the family is supplied with food by the relatives. On the third day the brethren all assemble in an open place and 1½ or 2½ *sers* of gram, some flowers, betel-leaf, and *sharbat*, are taken there. Each man then takes up a grain of the gram, and after reciting a benediction over it drops it on a cloth spread for the purpose. The benediction is called दारूद (درود) *darūd*. They go on doing this till all the grain is exhausted. It is then given to beggars, and the *sūra* or chapter of the Qur'an entitled *qul huwa-l-lāhu* is read. Each one then drinks *sharbat*, takes betel-leaf, and the meeting separates. This ceremony is called by the educated कुल (کول) *kul*, from the first word of the title above quoted. By the ignorant it is called पान फूल *pān phūl*. It is the conclusion of the funeral ceremonies.

CHAPTER X.—CEREMONIES AT PLOUGHING AND SOWING AND TRANSPLANTING.

1433. In the south-west on the first day of ploughing the villagers scatter rice-flour over the plough and yoke. This ceremony is called *समहृत samahut*. A similar ceremony is the *हरमहूरत harmahurat* north of the Ganges, also called *समहृत samahut* in Tirhut, in which a handful (मूँठ *mūnth*) of grain is thrown into the field at the north-west (मन्दार *bhandār*) corner. In South Munger the plough is worshipped. The ceremony is called *हरमोतर harmotar*, and in it a vessel of water is poured over the plough in the name of the earth-goddess *धरती मातर dharti māi*.

1434. In South-West Shahabad the *मूँठ पूजा mūth pūja* is the feast at the time of commencement of sowing. The villagers give handfuls of grain to the herdsman and watchman. It is also called *दिहवार पूजा dihwār pūja*. In South Bhagalpur the *मूँठ पूजा mūth pūja* consists in the cultivator feeding his labourers on rice and milk. On the last day of sowing broadcast, a small quantity of seed is brought back to the homestead and shut up in an earthen pot (कुँडा *kūnda*), after which food of extra quality is prepared. This is called generally *कुँड-मुन्दन kunrmundan* or *कुँड-मुन्दन kunrmūnan*; also *हरसोधान harsodhan* in Champāran.

1435. On the first day of transplanting rice a feast is given. This is called *पहिरौप pahiroop* in Patna, and *पहिरौपा pahiropa* in the south-east. In East Tirhut it is *खेत भोज khet bhoj*, or *खेत भोजनी khet bhojni*. South of the Ganges on this occasion the cultivators face the east and plant five rice seedlings (मोरी *mori*). This is called *पंचाईत panchāit* in Shahabad, and *पचाँटी pachānti* elsewhere. On the same occasion in South Bhagalpur wine, milk, fried grain, and oil are offered to the gods who protect the field from blights and mildews. This ceremony is called *गोखी gochhi*. In South Munger on this occasion a deity of the *मुशर mushar* caste, named *मुकुन्दगवा Murkatwa*, is worshipped. The legend about him is that a cultivator once sent this man, who was his labourer, home from the fields to get some seedlings. On the labourer's return the cultivator observed a spot of vermilion (सिद्धर *senur*) on his forehead, and concluded that he had been debauching his (the cultivator's) daughter, who was at home at the time, and had given the seedlings. The man was quite innocent, but the cultivator in a rage killed and hid him in the earth. He is hence worshipped as a martyr, especially by his caste-fellows.

North of the Ganges, on the first day of transplanting a feast is given to the neighbours. This is known as गवा गवा or गवा *gāwa*, and to give it is गवा देव *gāwa leb* or गवा जमाएव *gāwa lagāēb*.

1436. The feast at the conclusion of rice transplanting is औजली *aunjli* in South Bhagalpur, बनसुरा *banusra* or बनसूर *banusār* in Gaya, and उखाड़ी *uchhāri* or बनसुआव *banukhāo* in Patna. In Sāran, when the transplanting is over, a handful of seedlings is planted with ceremony in a corner of the field. This is called केना देहरी *kena dehri*.

1437. In planting sugar-cane, before commencing, the direction of the wind is tested to judge of the probability of rain. This is called पवन परिच्छा *paban parichchha* in the north-west. The day on which the planting of this crop, as well as of the spring crop, is commenced, is called मूठ *mūth*, and when it has come they say मूठ लागल *mūth lagal*. When the planting is concluded five long canes are planted in the middle of the field. This is called पंचसुख *panchukh* or पंचौख *panchaukh* north of the Ganges, and पक्खान *pachkhān* south of it.

CHAPTER XI.—HARVEST CEREMONIES.

1438. When the crops are out, some of the new grain is taken home and eaten with certain ceremonies. This feast is known as नेवान *newān* or नेवानी *newāni*, or to the south-east as नेमान *nemān*. When the grain is collected on the threshing-floor, a cake of cowdung is placed on the top of the heap to avert the evil eye (see § 839). South of the Ganges worship is also done to the village deity or दिवदार *dihwār*. A similar worship in South Bhagalpur to propitiate ghosts is called दावो पूजा *dāno pūja*.

1439. The ceremony of the first cutting of the sugar-cane takes place, south of the Ganges, on the festival of the देव उठान *deb ūthān* or देवठाण *deothān*. This takes place on the 11th of the bright half of Kātik (*i.e.*, early in November), and is said to be the day on which Vishnu wakes from his four months' sleep. In South-West Shahabad, on this day, the villagers tie a few canes together by the leaves, and place a neck-ring (हंसुली *hansuli*) on the top. They then pour perfumes over it, take the neck-ring away, and commence cutting. When the crushing of cane is begun a ceremony is performed, called पिठार *pithār* in South-West Shahabad, समझव *samahut* in the rest of that district, पेतवान *petāwan*

in Patna and Gaya, and पचघन *pachghan* in the south-east (see also § 299).

1440. In Shahabad, on the first day of crushing cane, the villagers take some juice home to cook with rice. This dish is called रसजावर *rasjāūr*. The ceremony at the first boiling of the juice is मिठार *mithāi* in the south-west, and सिरनी *sirni* in Patna and Gaya. A similar worship of a god, who is called कोइला माता *Koila Māta*, exists in the south-east. This god exists elsewhere as a deity protecting wells.

CHAPTER XII.—MISCELLANEOUS.

1441. Among the lesser known festivals may be mentioned the following. The अरस *āras* or चिरागा *chirāga* is, south of the Ganges, a festival held in honour of the Musalman saint मखदूम शाह *Makhdūm Shāh*. It takes place on various dates in different places, e.g. in Patna City it takes place in the month of *Bakrā'id* (about December), and at other places in *Bārah wafāt* (about Maroh). मखदुमाना *makhdumāna* is a rite performed in his honour by landlords.

1442. The छठ वरत *chhath bart* is a Hindu festival in honour of the sun held on the 6th of the light half of Kātik (early in November). The दवात पूजा *dawāt pūja* is held by men of the Kayasth caste on the 12th of the light half of Kātik (i.e., the day but one after the *divālī*). On this day they worship their inkstands and will not touch pen and ink.

1443. In the north and east, on the 3rd Bhādoñ (August–September) occurs the तीज *tij*, on which women fast a day and night in honour of the goddess पार्वती *Pārbati*, and eat सत्तु *sattu* (ground parched grain) next day. On the last day of Bhādoñ occurs the अनंत *anant* or अनत *anat*, on which day both men and women fast. In the same tract the बहुरा *bahura* is a festival on which the women eat सत्तु *sattu* with sugar and clarified butter.

1444. The अखरतीज *akhartij* in Patna, अखरतिजिया *akhartijiya* in Gaya, and अखरतीज *akhartit* in South-West Shahabad, is the feast on the 3rd of the light half of Baisākh (early in May), on which the obligations of the spring harvest are cleared off. In South Bhagalpur it is called अचे तिर-तिजा *achhai tirtiya*.

1445. On the 5th of the light half of Sāon (early in August) occurs the feast of the नाग पञ्चमी *nāg panchami*, also known as हाग पञ्चमी *hāg panchmi* in North-East Tirhut, नक्षत्रांचे *nakpānche* in Shahabad, नगर्पांचे *nagpānche* in Patna and Gaya, and लगर्पांचे *lagpānche* in the south-east. On this festival the women mark their houses with lines of cowdung, and worship सेशनाग *sesnāg* (the Serpent of Eternity) with milk and parched grain (लावा *lāwa*). On the गोबर पांचे *gobar pānche*, which falls on the 5th of the dark half of the same month (late in July), the same god is often worshipped in Patna instead of on the former festival. This is called बेहरा पांचे *behra pānche* in South Bhagalpur.

1446. गोधन *godhan* is a woman's rite in which they make cow-dung figures of scorpions, snakes, &c., and beat them. To the south of the Ganges, in Bhādoñ (August-September), the women fast for twenty-four hours and make cowdung figures of Ganes and lay brambles (जाड़ जूड़ *jhār jhār*) in the court-yard, saying the words अप्पन करन्म मेवक करन्म जाड़ जूड़ हुषिवावे वी *appan karm bhaiyak dharm jhār jhār ghusiāwe hi*, an incantation which literally translated means, 'I cause my own fate and my brother's virtue to enter the bramble.' This incantation is supposed to benefit the speaker and her brother in some mysterious way. A similar ceremony is called करन्मा करन्मा *karma dharmā* in South Bhagalpur.

1447. The जिउतिवा *jiūtiya* to the west and the जितिवा *jitiya* to the east is a fast and worship performed by women on the 8th of the dark half of Kātik (late in October) for the benefit of their children.

1448. In Patna the festival of the *hōi* festival (full moon of Phāgun or middle of March) is distinguished by the custom called लुकारी *lukāri* or लुकवारी *lukvāri*. In this, at night, the village children throw lighted torches across the boundaries of the village into the neighbouring village. This is supposed to be lucky for the village which throws, and unlucky for the village which receives, and is a source of frequent fights.

1449. On the day between the 15th of Chait and the 15th of Baisakh (about the 15th of April) when the sun enters the sign of the Ram (मेख *mekh*), it is customary to feed Brāhmins with सत्तु *sattu* (ground parched barley), तिकोड़ा *tikorha* (immature mangos), and water, and to give alms. This feast is called the सतुआइन *satudāin* or सतुआनी *satudāni*. In South Bhagalpur this festival is held on the last day of Chait, i.e., the last day of the

Bangali year. On the following day there is in Tirhut a curious festival, called the जूड़ बीतल *jūr sital*. The people bathe in water drawn the previous night and eat food cooked at that time, after worshipping सिता देवी *Sitla Debi*, the goddess of small-pox. Then from morning till noon all classes, rich and poor, cover themselves with mud, and shower it on all whom they meet. No one is free from this mud bath. In the afternoon the people go out with clubs and hunt jackals and hares and whatever animal they can find in the village. On their return home they boast of their valour in having killed this and that jackal, and the phrase जूड़ बीतलक सिपाही *jūr sitalak sipāhi* is used like मोहरम के सिपाही *moharram ke sipāhi* to signify a braggard.

CHAPTER XIII.—ARBITRATIONS, OATHS, &c.

1450. A body of arbitrators is पंचारत *pañchātī* to the north and west. In Patna and Gaya it is पंचौत *pañchūt* or पंचेता *pañcheta*, and in the south-east पंचैती *pañchaitī*. The head arbitrator is called सरपंच *sarpanch*, also south of the Ganges सरदार *sardār* or महन्तों *mahton*. In Shahabad he is also called महान *mahān*, and in South Bhagalpur मंडर *mañrar*. A caste assembly is चढार *chatāi* (*lit.* a mat), or पङ्गत *paṅgat* (*lit.* sitting in a row), and its head arbitrator परधान *pardhān* or मानजन *mānjan*. In Shahabad the man next to the chief is called the चढ़ीदार *chharidār*.

1451. When one party in the case challenges the opposite party or a particular person to an oath, the phrase used is हसर करब *hasar karab*; also धारब *dhārab* in Patna, Gaya, and the south-east. The oath may be on the ammonite (साङ्ग्राम *sāṅgrām* or साङ्ग्राम *saligrām*), a copy of the Sanskrit हरिवन्ध *haribans*, or on Ganges water (गङ्गा जल *ganga jal*). When Ganges water is placed in a copper vessel with some leaves of the holy basil (*Ocimum sanctum*), the oath is said to be by तुलसी ताँबा *tulsi tāmba*. Or a man may lay his hand on his son's head (बीटा का सिर पर हाँथ पै केँ *beta ka sir par hānth dhai kañ*), in which case his son is supposed to die within a year if he tells a lie, or he may touch a Brāhman's legs and swear by them (ब्राह्मन केँ गोर छु केँ *Brāhman ke gor chhu kañ*). In Shahabad one form of oath current is to pour forth some country liquor. This form is known as महारन *maddān*. The oath taken on a cow is

known as गौ किरिया *gau kiriya*. The man who swears by this oath sometimes holds the animal's tail, and sometimes simply touches it. In these cases the man before swearing bathes and puts on new clothes. North of the Ganges the गुरुदा *guruda* is a circle drawn on the ground in which the man who takes the oath stands, or from which he takes the thing claimed. The belief in these oaths is, throughout the country, very genuine, but perjury is sometimes attempted. One common trick when swearing with one's hand on one's son's head is to substitute some one else for the son. The writer remembers in the year 1879, when he was in camp in Darbhanga district, a curious incident. License-tax assessments were being held, and one well-known money-lender offered to swear on his son's head that he lent no money. The challenge was accepted, and the oath taken. Curiously enough the son was next day seized with what was said to be cholera, and the man came to the writer, and insisted on his name being written in the highest class of assesseses. This was done. It is satisfactory to know that the son recovered. Bābhans are popularly supposed to have little fear of the sanction of an oath, as witness the following proverb,—सोच, सुन, चरिबन्ध ले, बीच गङ्गाक धार, एतेक ले बाभन, नै ना करब इतिवार *sil, sut, haribans lai, bich gangāk dhār, etek lai bābhan nai na karah itibār*, If a Bābhan swear by the ammonite, his son, the Haribans, and in the midst of the Ganges,—don't believe him.

1452. To excommunicate from caste is ऊडा (or ऊडा तमाकु) बन्द करब *hukka (or hukka tamāku) band karab*. It is also कुजात करब *kujāt karab* or पंचारत सेँ काट देब *pañchāt señ kāt deb*. The headman of a caste is मुखिया *mukhiya*, चौधरी *chaudhri*, सरदार *sardār*, or मानन्जन *mānjan*. Amongst the Telis and Chamārs he is also called महणों *maḥṭon*, मेहनार *mehtar*, or (in South-East Tirhut), मँरुव *mañrar*.

CHAPTER XIV.—MISCELLANEOUS SUPERSTITIONS.

1453. A wizard is ओजा *oja* or जादूगर *jādūgar*. Other names also used are सोखा *sokha* in South-West Shahabad, गुनी *guni* in North-East Tirhut, दैया *daiya* in Patna, भगत *bhagat* in Patna, Gaya, and the south-east, and also भगतिया *bhagatiya* and चटिया *chatiya* in South Munger. His enchantments are जादू *jādu* or ओजार *ojhāi*, also भगन्तार *bhagṭāi* in South Bhagalpur. A witch is दारन *dāin*.

1454. An omen is सगुन *sagun*, and also north of the Ganges शगुन *shagun*. A good omen is अच्छा सगुन *achchha sagun*, or in Shahabad

दुखन सुख *sulabh sagun*. An evil omen is कुसुख *kusagun*, also in the north-west बदशुख *badshagun*, and in Patna and Gaya नहस *nahas*. In East Tirhut it is असुख *asgun*. Other names are कुधारन *kusāit* (an unlucky time) and कुजात्रा *kujātra* (an unlucky starting).

1455. There are a vast number of village gods (ग्राम देवता *grām deota*) worshipped throughout the province. The principal amongst them will shortly be mentioned. A काली अस्थान *kāli asthān*, also called देवी अस्थान *debi asthān* or देवी थान *debi thān*, which is a mound in honour of Kāli, the wife of Shiva (सिब *Sib*), is generally erected outside each village. In Tirhut under the village *pīpal* tree there is generally a mound, decorated with clay images of the principal personages in the epic connected with him, erected in honour of the Salhes who is mentioned in the following list. This is called a सलहेस अस्थान *salhes asthān*. The mound erected to a deceased Brahman or holy man is generally called a बरन्वस अस्थान *barham asthān*.

1456. The following is a list of the principal village deities worshipped in Bihār. The more well-known deities, such as सिब *Sib*, महादेव *Mahādeb*, बरन्वस *Barham* (*Brahma*), or कृष्ण *Krishn*, are omitted. It will be observed that some of them are demons, who are worshipped in order to propitiate them.

अमता भवानी *Amta Bhawāni* or अम्बिका भवानी *Ambika Bhawāni*, a form of Debi worshipped in Sāran.

कारु बीर *Kāru Bir* or कारु दास *Kāru Dās* (south), also कलुषा बीर *Kalua Bir* (Patna), worshipped by Doms and Dusādhs.

कुल देवता *Kul Deota*, the family god.

कैतुक गोसाँई *Kaituk Gosāñīñ*, worshipped in South Bhagalpur by Dusādhs.

कोरवा माता *Koila Māta*, the goddess of a well spring, worshipped generally.

कोदर कटा *Kodar Katta*, worshipped by Doms in South Bhagalpur.

कोल *Kol*, worshipped in Gaya.

खाजे खिदर *Khāje Khidar*, the patron god of the boatman (मल्लाह *malāh*) caste. He is also often confused with a similar female deity गङ्गा माता *Ganga Māi*. Musalmān women fast on every Thursday in the month of Bhādoñ (August–September) and call the fast खाजे खिदर का रोजा *khāje khidar ka roja*.

खेती भवानी *Khēti Bhawāni* (Patna and south-west), worshipped by Koiris when they plant and cut their vegetables. In Patna a Musalmān vegetable-seller (कुंजरा *kunjra*) worships राम ठाकुर *Rām Thākur*.

गोबन्दार राखन *Gobndāi Rāit* (north-west), a deified cowherd worshipped in Sāran and Champāran.

गोरैया *Goraiga* or गोरैया *Gorea*, worshipped generally south of the Ganges, especially by Doms and Dusādhs; also called गोरिया *Goriya* (Patna).

घाटौ *Ghāton*, worshipped in South Bhagalpur by Dusādhs.

चतावन *Chatawan* (Patna), worshipped by Doms and Dusādhs.

चिरकुटवा पीर *Chirkutwa Pīr*,—see चिह्नवार *Dihwār*.

चुहड़ माल *Chuhar Māl*,—see सल्लेह *Salhes*, worshipped in the south-east by Dusādhs.

चोहट *Chohat*, worshipped by Doms and Dusādhs.

जगन्माया *Jagdamma*, the goddess of small-pox, worshipped in Patna and the south-east by Dusādhs.

जलासेन *Jalāsen*, the protector of bearers, worshipped in Sāran.

जौहरी बरन्म *Jauhri Barm*, worshipped in Sāran.

जुन्की पीर *Jhunki Pīr*, worshipped in Gaya.

दमरदाक *Damardāk* (south), worshipped by Doms and Dusādhs.

दाक *Dāk*, worshipped in Patna, Gaya, and South Munger.

चिह्नवार *Dihwār* (generally), also (Sāran and South Tirhut) चिरकुटवा पीर *Chirkutwa Pīr*. This is a very generally worshipped deity. There is supposed to be a separate one for each village. Every one who passes by throws a piece of cloth on his image.

धेहवा पीर *Dhelha Pīr* (north) or धेहवा गोसाँई *Dhehwa Gosāññ* (south), in whose honour a heap of earth is erected on the road-side, to which every passer-by adds a clod. He protects wayfarers.

देवी *Debi*, the popular name of the goddess Durga.

धरन्मनाथ *Dharmnāth*, an incarnation of Sib, worshipped in Sāran.

नाटक साहेब *Nāek Sāheb*, worshipped in Patna.

नाग *Nāg*, the snake god. Worshipped generally. In Sāon (July–August) crowds of women calling themselves his

wives (नागिन *nāgin*) go out begging for 2½ days, during which period they neither sleep under a roof nor eat salt. Half the proceeds of the begging are given to Brāhmanas, and the other half invested in salt and sweetmeats, which are eaten by the whole village. During the expedition several characteristic songs are sung, some of which have been published by the Asiatic Society of Bengal.

महन्धिन दार *Mahthin Dāi*, worshipped in the south-west.

पहास बर *Pahās Bar* (Patna and Gaya), worshipped by Doms and Dusādhs.

पाँचो पीर *Pāncho Pīr*, the five saints named गाजी मौबाँ *Gāji Miyān*, हठीला *Hathīla*, परिवार *Parihār*, सख्खा नार *Sakhā Māi*, and अजब सालार *Ajab Sālār*. They are worshipped by Musalmān drummers (दफाली *daphālī*), who during an outbreak of cholera act as village Musalmān priests. They go about, beating drums, with an iron bar wrapped in red cloth and adorned with flowers, which represents गाजी मौबाँ *Gāji Miyān*. They are paid in kind by the people at whose doors they stop and drum. A पंचपिरिया *panchpiriya* is a Hindu who worships Musalmān saints. In Shahabad these five saints are worshipped conjointly with three others, as mentioned in the following verse :—

अमना सती, पाँचो पीर, लंग्रा तार, सोबर्ना तीर *Amna Sati, Pāncho Pīr, Langra Tār, Sobarna Tīr*.

Langra Tār is simply a crooked wire which is worshipped. *Sobarna Tīr* means the banks of the river *Sobarna*.

पारस नाथ *Paras Nāth*, worshipped by bankers (महाजन *mahājan*).

फूल दाक *Phāl Dāk* (Gaya), worshipped by Doms and Dusādhs.

बख्तौर *Bakhtaur*, a deified cowherd worshipped in South-East Tirhut.

बंदौतनी *Bandautni* (Gaya), worshipped by Doms and Dusādhs.

बंदौत *Bandaut* (Gaya), worshipped by Doms and Dusādhs.

बन्नी *Banni* (south-west), worshipped by Doms and Dusādhs.

बरद्वनिषा *Bardwaniya*, worshipped in Patna.

बरहम देव *Barham Deo*, worshipped in Gaya.

बसावन कुंवर *Basāwan Kuñar*, worshipped in Gaya.

बहोर *Bahor*, worshipped in Patna and South Munger by Dusādhs.

बिदेसी बरम्ब *Bidesi Barm*, worshipped in Sāran.

बिचहरा *Bisahra*, worshipped in North-East Tirhut.

भैरव *Bhairab* or भैरो *Bhairo*, worshipped by cultivators in the south-east.

मकार बीर *Makar Bir* (north and east),—see § 299.

मनन्दा राम *Manea Rām* (Patna), worshipped by Doms and Dusādhs.

मनामो दानो *Manāno Dāno*, worshipped by Doms in South Bhagalpur.

मनुष देव *Manus Deo* (north and west), worshipped by Doms and Dusādhs.

मलदानी *Maldāno* (south), worshipped by Doms and Dusādhs.

मसान *Masān* (Patna), worshipped by Dusādhs and Doms.

मन्माया *Mahmāya*, the goddess of small-pox.

महाबीर *Mahābir*, a form of Hanumān, the monkey-king who befriended Rām.

माता दाई *Māta Dāi* or चित्तनी *Sitī*, the goddess of small-pox.

मीर फजुला *Mir Phajula*, a Musalmān saint worshipped in Sāran.

मेघु डाक *Meghu Dāk* (Patna), worshipped by Doms and Dusādhs.

मैया *Maiya* (Patna and south-east), worshipped by Mushars, Dusādhs, and Doms.

मोती राम *Moti Rām*, brother of सल्लेख *Salhes* (q.v.), and worshipped in the south-east by Dusādhs.

रघुनी डाक *Raghuni Dāk* (Patna), worshipped by Doms and Dusādhs.

रघु *Raghu*, worshipped in South Bhagalpur by Dusādhs.

राम ठाकुर *Rām Thākur*, worshipped in Patna and the south-east. See also खेती बवाजी *Kheti Bhawāni*.

राम बीर *Rām Bir* (Patna), or राम गोसाँई *Rām Gosāisāi* (Gaya), worshipped by Dusādhs.

राह *Rāh* or (North-East Tirhut) राहु *Rāhu* is a demon worshipped by Doms and Dusādhs. The ceremonies are a kind of fire-worship, in which the devotees run along a trench filled with blazing coals.

लीला डोम *Lila Dom*, worshipped by Doms in South Bhagalpur.

सनिचरा *Sanichra* (south-west), a god worshipped by vegetable-sellers (तुरहा *turha*).

सल्लो *Salkho* (south-west), worshipped by Doms and Dusādhs.

सल्लेस *Salhes* or सल्लेस *Sales* (south and east), worshipped by Doms and Dusādhs. He was a great hero and the first watchman. He fought a battle with चुहड़ जाच *Chuhar Māi* of Mokāma, who was the first thief. A famous epic concerning him is current in Tirhut, and has been published by the Asiatic Society of Bengal.

सह्यादी मार *Sahyādi Māi*, worshipped in the south-west.

सिंगेसर *Singesar*, worshipped in North-East Tirhut.

सरिराम बरम *Harirām Barm*, worshipped in Sāran.

सरिहर जाच *Harihar Nāth*, in Sāran, at Sonpūr.

1457. A spell or charm is गुन *gun* or मन्त्र *mantr*. डोटका *totka*, डोटमा *totma*, or टोना *tona*, are spells or charms generally with an evil object. In Shahabad they were डोटरम *totram*; in Patna and Gaya they are optionally उतारा पतारा *utāra patāra*, and in South Bhagalpur निंगछा छोरी *ningchha chhori*. The जिबा दान *jiba dān*, जिबदान *jib dān*, or बलिदान *balidān*, is an animal, &c., sacrificed to काली *Kālī* as a kind of scapegoat. In cases of sickness various articles are exposed in a saucer at a cross-road. This custom is supposed to communicate the disease to the first person who touches it, and is called जोग *jog* or जोग डोम *jog ton*, or in South Bhagalpur जोम टेम *ojh tem*. The contents of the saucer vary with the disease demon to be propitiated. There are generally some red ओढ़ौल *orhaul* (*hibiscus*) flowers, some sand, grain, and yellow cloth. If a ghost भूत *bhūt* has to be propitiated, wine, or even a fowl, is laid there. In cases of small-pox, the cloth with which the sores were dressed is frequently put out, which often makes the superstition about communicating the disease a lamentable reality. In South-East Tirhut an oblong mound studded with flags to avert cholera is called आंसरिह *āsrik*. The खटोला *khatola* (north of the Ganges) is a miniature bedstead hung on a tree as a propitiatory offering.

1458. The following is a list of some of the various demons, ghosts, and other supernatural bogies believed in in Bihar. Those which are worshipped, and which hence have been included in the former list, are omitted.

- आगि बैताल *Āgi Baital* or अग्निबा बैताल *Āgiya Baital*, a hideous demon which lurks in trees, lives on dung beetles, and seizes wayfarers by night.
- कीचिन *Kichin* (south), a kind of Lamia. She assumes the shape of a beautiful woman, and visits and seduces any man whom she may meet in a lonely place. The man dies within a few months of his yielding to the temptation. She has feet back to front, *i.e.*, toes behind and heels in front. Hence the wise may recognize her.
- घोघर *Ghoghar* (north-west), a ghost invoked to frighten children.
- चटुवा *Chatua* or चटुन्डा *Chahta* (north-west), चटुन्डा *Chatna* (north-east), a vampire who drinks up the milk of cows and women. In South Bhagalpur he is called चोर मटुन्डा *Chor Matka*.
- चुरैल *Churail*, also (in Shahabad) बहरिया *Bahariya*, an evil spirit which assumes the shape of a bird and sits on the roof of a house which contains a pregnant woman. This injures the child.
- जिलेबा *Jilaiya* or जलन्वेबा *Jahwaiya* (south), or (South Bhagalpur) मरचिरिया *Marchiriya*, a fiend which takes the shape of a night bird, and is able to suck the blood of any person whose name it hears. Hence women are very careful about calling their children by name in the night time. If it fly over the head of a pregnant woman, the child born will be a weakling. Such a child is called जिलन्वेबा के छुचल *jahwaiya ke chhūal*.
- जिन *Jin* (north), a ghost, goblin, genius, 'djin.'
- डूबा *Dūba*,—see बूडा *būra*.
- धोकर कसवा *Dhokar Kaswa*, a man with a bag who carries off naughty children.
- नेकी बीबी *Neki Bibi* (Gaya and south-west), a ghost invoked to frighten children.
- पलन्दूबी *Pandūbi*,—see बूडा *būra*.
- बरनम पिचास *Barn Pichās*, a kind of ghost or goblin.
- बूरे *Būi* is a ghost invoked to frighten children.
- बूडा *Būra*, डूबा *Dūba*, or पलन्दूबी *Pandūbi*, a water-demon, who drowns travellers.
- बौधेर *Baupher* (north), a kind of ghost or goblin.

भाङ्कुर *Bhakur* (north-west), a ghost invoked to frighten children.

भूत *bhūt*, a ghost or goblin generally.

भोकसन्ना *Bhokaswa* (south), a ghost invoked to frighten children.

मनुसन्देवा *Manusdeba* (north), a kind of ghost or goblin.

मरुचिड़िया *Marchiriya*,—see जिहवा *jihvaiya*.

माँची *Māñō* (north), a ghost invoked to frighten children.

मिमिचार् के तेल *mimiyā ke tel*, a kind of bitumen brought from Persia and elsewhere. It is said to be extracted from the heads of coolies who emigrate to the colonies, by hanging them head downwards and roasting them over a slow fire. The threat of extracting it from the head of a child is therefore an active deterrent.

राकस *Rakas*, the will o' the wisp ; it breathes fire and misleads travellers, but it also lives in the fields, and where it resides grain is produced in abundance.

सुखन्ना *Sukhra* (north), also सुखेनी *sukhaini* (North-East Tirhut), a vampire which sucks up children's blood.

हाल *Hāi* (Patna), or हम्मा *humma* (South Bhagalpur), a ghost invoked to frighten children.

1459. The उत्सर्ग *utsarg*, and also (in Tirhut) काननोत्सर्गे *kān-
notsarg*, is the emblematical marriage of a grove to a well, without which preliminary observance it is unlawful to partake of the fruit. The बिरखोत्सर्ग *birkhotsarg*, and also (in Tirhut) the बैदिक *baidik*, is the ceremony of marriage performed in the name of a bullock let loose on the 11th day of mourning for a near relative. The जलोत्सर्ग *jalotsarg* is the emblematical marriage ceremony on completion of a well or tank. It is married to an image erected close by. In case of a pond it is also called तरागोत्सर्ग *tarāgotsarg*, and on completion of a well कुपोत्सर्ग *kupotsarg*. The latter is called in South Bhagalpur कूप जग *kup jag* or कुइयाँ दान *kuiyāñ dān*. बाटोत्सर्ग *bātotsarg* is the ceremony on the completion of a road. No marriage is in this case performed.

1460. Water brought from a sacred river, spring, or place of pilgrimage तीरथ (*tirath*), is much used in religious ceremonies, and is carried by men called कामरन्पन्थू *kamarpanthu*. They are also called कामार्थू *kamārthu* in South-West Tirhut and कामरथुवा *kamrathua* in South-East Tirhut.

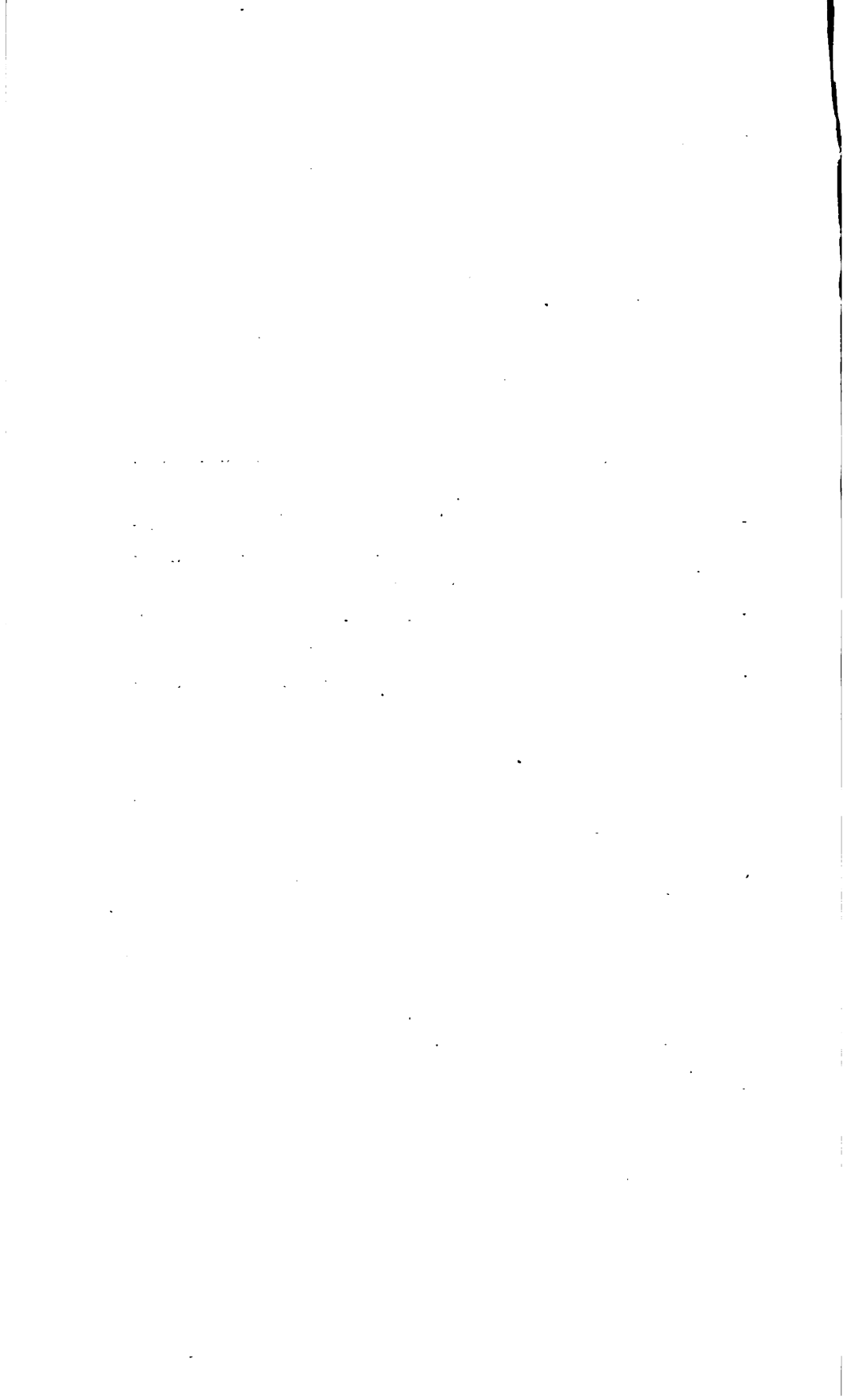

DIVISION XIII..

TRADE, MONEY-DEALING, AND ACCOUNTS.

CHAPTER I.—TRADE AND BAZAR ACCOUNTS.

1461. *Trade* is लेन देन *len den*, महाजनो *mahājni*, कारबार *kārbār* or कारोबार *kārobār*, बेवन्दार *beohār*, बेबापार *beyāpār* or बेबोपार *beopār*, or बनिज *banij*. In Patna City it is also बेवन्दरगत *beohargat*. *Exchange* or *barter* is बदलई बदलई *adlai badlai*. A *money-lender* is महाजन *mahājan*, साह *sah* or साहकार *sāhukār*, or बेवन्दरिया *behwariya*. He is also called in the country बनिजा *baniya*, and in South-West Shahabad साह *sāo*. In Patna City he is called कारोबारी *karobāri* or धनी *dhani*. A *banker* is कोठीवाल *kothīwāl* or सराफ *sarāph*. A *borrower* is रिनिहा *riniha*, खदुक *khadduk* or खदुका *khaduka*, or असाही *asāhi*. In South Munger he is also called मुजेरा *mujera*, in South Tirhut बनिबौटा *baniyauta* and धारनिक *dhārnik*, and in South Bhagalpur खातब *khātab*. In Patna the words करज चौक *karj khauk* and करज खोर *karj khor* are also used.

1462. An *account-book* is बही *bahi*. A trader's account-books are called collectively बही खाता *bahi khāta*. जाकर *jākar* in Gaya is a record of cloth sales kept by cloth-merchants. Each page of the account-book is called पन्ना *panna*, and also in North-East Tirhut पत्ता *patta*.

1463. The following are the books usually kept by village money-lenders:—

- (a) The रोजनामचा *rojnamcha*.—This is the *day-book*. The left hand or credit side of the page is known as जमा *jama*, and the right or debit side as नाँव *nānw* or नाम *nām*.
- (b) The रोकड़ बही *rokar bahi*—Mr. Crooke's description of this is equally applicable to Bihār. It is exactly the same as the रोजनामचा *rojnamcha*. There is only this difference,

that it is balanced after each transaction. For example, the book shows Rs. 1,000 on the credit side; Rs. 100 are disbursed on a certain account. This is entered on the debit (बाकी *baki* or बाँव *nāw*) side, and the book is balanced showing Rs. 900 still to credit. This is called रोकर बाकी *rokar baki* or बाकी तबदील *baki tabdil*, and is again brought forward to credit. North of the Ganges it is called फाजिल *phājil*. A man who carries on several distinct trades keeps up a separate रोकर बाकी *rokar baki* for each.

- (c) The लेखा बाकी *lekha baki*, the खाता *khāta*, or खाता बाकी *khāta baki*.—This is the *ledger*, and is made up as time allows from the रोजनामचा बाकी *rojnāmcha baki*. It contains each creditor's or debtor's account separately, with a reference to the page of the day-book on which each item has been entered day by day. Some traders keep up a separate खाता बाकी *khāta baki* for each of their trades or speculations, others have only one general one.
- (d) There is also the जमाखर्च *jamakharch*, which is an abstract of the day-book, and is hence also called a खतिबौनी *khatiyauni*, and shows the totals of receipts and payments on each page.

1464. Small traders generally only keep up the first of these books, —the रोजनामचा *rojnāmcha* or day-book. Very small traders do not even keep this. They have a separate slip of paper containing each customer's account, and called चिट *chit*, चिट्ठा *chittha*, or चिट्ठी *chitthi*, or पुरजा *purja* or पुरजी *purji*. In South Munger it is called सरखत *sarkhat*.

1465. Large traders, such as those in the city of Patna, with whom this work has nothing to do, keep up all the above four books. For the sake of completeness, the following information, founded on that given by Elliot in his Glossary, is added. Quoting Elliot's words (with the necessary alterations to suit local variations): "The page (of an account-book) is divided into two equal parts, called in Patna रेकाना *rekāna*: each of these is again divided into two रुकन *rukan* or रुकन *rukūn*. The (first or) right-hand रेकाना *rekāna* is called the हाशो *hāsho*. The first right-hand quarter (some say half) of the left-hand रेकाना *rekāna* is called शीरा *shira*, and the remaining portion is called in Patna City

ररादा *irāda*, and elsewhere पेडा *peta* or (in North-East Tirhut) पेड *pet*. The सीरा *sira* contains the sum finally brought to account after the necessary deductions have been made from the gross amount in the पेडा *peta* and चामो *hāsho*." In reading the above, it should be remembered that it refers to accounts kept in the Persian character. When kept in the *mahājni* character, the terms for right and left must be reversed.

CHAPTER II.—ACCOUNTS BETWEEN LANDLORD AND TENANT.

1466. These accounts are not usually kept in bound books, but on separate slips of paper, kept together in packets by a paper tape, called तबलक *tablak* or कैदक *kaidak*.

1467. A tenant's receipt for rent is known as रसीद *rasid* or दाखिला *dakhila*, and in North-East Tirhut कबज *kabaj*.

1468. The system of accounts differs according as the rent is paid in kind or in cash. Hence two sets of accounts are kept up in a landlord's office. They are the following :—

(a) Accounts of rents paid in kind—

1. खसरा दानाबन्दी *khasra dānābandī*.
2. खसरा बटार *khasra batāi*.
3. मोफरीद *mophrīd*.
4. उजित *laggit* and वासिल बाकी *wāsil bākī*.
5. तिरिज जिमिस्वार *tirij jimiswār*.
6. सिवाहा *siyāha*.
7. सिवाव बिकरी गला *hisāb bikri galla*.

(b) Accounts of rents paid in cash—

8. खसरा *khasra*.
9. मोफरीद *mophrīd*.
10. उजित *laggit* and वासिल बाकी *wāsil bākī*.
11. तिरिज पटेवारी *tirij patewāri*.
12. सिवाहा *siyāha*.

(c) In addition to the above, the following general accounts are kept, which are applicable to both kinds of rent—

13. मोलहाकी *molhākī*.
14. डड्डा *dhaddha* or जमा वासिल बाकी *jama wāsil bākī*.

15. जमाबन्दी *jamābandī*.

16. जमाखर्च *jamākharḥ*.

1469. The word तिरिज *tirij*, met with above, means 'abstract.' In small estates, Nos. 5, 11, and 14 are often not used.

1470. The following is a brief description of the above accounts :—

(1) The खसरा दानाबन्दी *khasra dānābandī*. This is the account paper drawn up in the field when the दाना *dāna* or estimate of the crop is being made. It contains—

(a) The date.

(b) Name of tenant.

(c) Quantity of land (बराजी *arāji*).

(d) Length (तूल *tūl*) and breadth (आरज *araj*) of the plot.

(e) Name of the crop (जिनिस *jinis*) thereon.

(f) The quantity of grain estimated.

The तिरिज तारीखदार *tirij tārikhwar* is a daily abstract of No. 1, and shows (in the case of division by appraisement) the total area of land and the quantity of grain estimated daily. The sum of all the daily entries in this paper shows the total area of lands of which the rent is paid in kind, and the produce thereof. This account is only kept when the division of the crop is by appraisement (दानाबन्दी *dānābandī*, see § 913). Some landlords, however, also keep it in the case of actual division on the threshing-floor, as a check on No. 2.

(2) When the division is by actual division on the threshing-floor (अगोर बटारी *agor batāi*, see § 914), a खसरा बटारी *khasra batāi* is opened instead, containing the date, name of tenant, area, kind of crop, quantity, landlord's share, cesses, &c.

(3) The मोफरीद *mophrīd* is the bundle of papers in which separate accounts of each tenant are entered. A separate slip of paper is kept for each tenant. It is compiled from the खसरा *khasra* (No. 1). It shows the quantity of each kind of grain belonging to him which was

estimated, date by date. The area of the land, under each crop at each estimate is also given. When this is abstracted out so as to show the total area and total crop for each tenant, the abstract is called *तिरिज मोफरीद tirij mophrid*.

- (4) The *लग्गित laggit* and *वासिल बाकी wāsil bākī* are written up from No. 3, a separate slip of paper being kept for each tenant. They form a kind of ledger or personal account. The heads are as follows,—the total quantity of each kind of grain and the area of land under each. The total share claimed by all the landlords (*बाकिमी हिस्सा hākīmī hissa*) is then struck off. From this the shares of the other shareholders, who keep accounts separate from the landlords whose accounts we are considering, is deducted. To the remainder the cesses and other dues (*अबवान abwāb*) are added. The total shows the quantity of grain realizable from the tenant by the landlord on whose behalf the account is prepared. This portion of the account showing the demand is called the *लग्गित laggit*. From the total demand the quantity of grain realized during the year is set off, and the balance, if any, is shown. The whole paper showing demand, realization, and balance is called the *वासिल बाकी wāsil bākī*. An abstract of the *लग्गित laggit*, showing under the head of each kind of grain separately the amount of crop of, and area of land under, that grain owned by each tenant, is called the *तिरिज लग्गित tirij laggit*. The abstract of the *वासिल बाकी wāsil bākī* is the *धुदा dhaddha* (No. 14).
- (5) The *तिरिज जिनिस्वार tirij jiniswār* is compiled from the *लग्गित laggit* (No. 4). It shows in one entry for each tenant the total area he has under cultivation, and the amount of each kind of crop demanded from him.
- (6) The *सिवाहा siyaha* is the day-book of receipts and disbursements of grain. An abstract of this, called the *अवारजा awārja* or *वारजा wārja*, shows the total receipts and disbursements, date by date.
- (7) The *हिदाब बिकरी मज्जा hisāb bikri galla* is the account showing the produce of the sale of the grain received as

rent. It shows the date of sale, quantity sold, rate, and price.

1471. We now come to the accounts of rent paid in cash.

- (8) **खसरा** *khasra* is the paper in which the area (i.e., **तल** *tāl* or length and **अरज** *araj* or breadth) as ascertained by measurement of the lands held by the tenants in a village, together with the rate per bigha or class (**पट्टा** *patta*) of each plot, is entered. An abstract of this shows the amount measured each day, while the measurement is going on, and is called **तिरिज खसरा** *tirij khasra*. This **खसरा** *khasra* gives only the measurement of the lands held temporarily on a cash rent, and differs from the regular **खसरा** *khasra* or measurement papers of a village.
- (9) **मोफरीद** *mophrid*.—This is similar to No. 3, *mutatis mutandis*. It shows the area and different rates of rent of the various plots held by each tenant. Each tenant has a separate slip of paper, and all lands for which cash rents are paid, whether temporarily or not, are included in it. It is compiled from No. 8 and No. 10. An abstract of it, called **तिरिज मोफरीद** *tirij mophrid*, shows the area of land held and total rent payable by each raiyat.
- (10) **लग्गित** *laggit* and **वासिल बाकी** *wasil baki*.—These are similar, *mutatis mutandis*, to No. 4. They are the ledger account of each tenant. Each tenant has a page, on which is shown the area of his plots, rate of each, rent of each, total area, and total rent. From this the shares of the other shareholders are deducted, and to the remainder the cesses and dues are added, together with the value of any rent in kind (**दामाव नका** *damāo galla*), due by the raiyat which has not been realized during the year. To this again the arrears of previous years are added, and the total shows the demand against the tenant. The paper thus far is called the **लग्गित** *laggit*. From the total demand is deducted the cash rent collected during the year, and the balance is struck to be carried to next year's account. The whole paper showing demand, realization, and balance is called

the वासिल बाकी *wasil baki*. An abstract of the खजिन *laggit*, called the तिरिज खजिन *tirij laggit*, shows under the head of each tenant separately the total area held and rent payable by him at each rate. The abstract of the वासिल बाकी *wasil baki* is the डफ़ा *dhaddha*.

- (11) The तिरिज पटेवारी *tirij patewari* is the paper in which the name of each पट्टा *patta* or separate class of land in the village is entered, showing the total area, rate, and rent of each class. The total shows the total area of land held at various rates in the village. This paper is compiled from No. 10.
- (12) The सिवाहा *siyaha* is the same (*mutatis mutandis*) as No. 6. In this the daily receipts and disbursements in cash, including the price of grain sold, are entered. It is, in fact, a cash-book. An abstract of this, called the अवारजा *awarja* or वारजा *warja*, shows the total expenditure day by day.
1472. The following accounts are applicable to both kinds of rent.
- (13) The मोलखकी *molhaki* is a ledger account for each tenant, showing date by date all payments (whether in cash or kind) made by him. It is compiled from the सिवाहा *siyaha*. An abstract of this, called तिरिज मोलखकी *tirij molhaki*, shows the total payments made during the year by each tenant. The totals of this should agree with the total of No. 12 (the सिवाहा *siyaha*) on the receipt side. It hence serves as an abstract of the receipt side of No. 12, while the अवारजा *awarja* is the abstract of the disbursement side.
- (14) The डफ़ा *dhaddha* is also called the तिरिज वासिल बाकी *tirij wasil baki* or जमा वासिल बाकी *jama wasil baki*. It shows the name of the tenant; area of his holding at each rent; amount of rent; additions on account of cesses, unrealized grain rent and arrears of previous years; deductions on account of shares of other shareholders; deductions on account of cash rent realized; and balance. This paper is in fact an abstract of the वासिल बाकी *wasil baki* (Nos. 6 and 10). The latter shows the accounts of each tenant separately,

whereas the *दृष्ट धाद्धा* shows all the tenants' accounts on one sheet of paper. This form of account is according to Field* said to have been invented by Udhmant Singh, of Nassipur, in the district of Murahidabad, in order to enable the zamindars to represent the collections as they pleased to the Muhammadan Government.

- (15) The *जमाबन्दी jamābandī* is the paper in which the total annual demand of the village on account of rent is entered. This paper does not usually show illegal demands from the tenants. These are generally shown only in the *जमाखर्च jamākharch* (No. 16).
- (16) The *जमाखर्च jamākharch* is the final annual abstract of the financial condition of the village. It shows the total demand, realization, and balance of the year in more or less detail. The demand side shows the balance of previous year, the total demand according to the *जमाबन्दी jamābandī* (No. 15), and other items of demand (such as fines, illegal cesses, &c.) which do not find their way into the latter. The total is the grand total of the demand for the year. This demand is on the other side of the account again divided into money spent and balance. The money spent includes the portion of the realizations which are forwarded to head-quarters, and the portion of realizations spent on the village and on miscellaneous expenses. The balance is made up of realizations in hand, and for which the village official or the landlord's grain-merchant is responsible, and of unrealized demand, the latter of which is given in detail. Some landlords have two copies of this paper,—one for their own information, containing the illegal cesses, and the other excluding them, so as to allow of its production in court.

1473. In the appendix to this work are given translations of the various forms of account as kept by a Patna landlord.

* Law of Evidence, p. 670.

CHAPTER III.—INTEREST, DISCOUNT, AND COMMISSION.

1474. *Discount and commission* are generally *सलामी salāmi*. *बटा batta* is also used south of the Ganges. In Patna they are also called *फिरना phiranta*. *बदन्ती barhti* is a *premium*. *सकररै sakrarai* is a *commission* of 3 or 6 pies per cent charged by the acceptor on accepting a bill. *नकररै सकररै nakrarai sakrarai* is a charge at 8 ānās per cent. on a drawer of a bill when his bill is not accepted. *जाबन्ता बाब जोग jābta sāh jog* is a commission at one anna per cent. when the bill is accepted in favour of a banker. *हंडियाणा hundiyāna* or *हंडियावन hundiyāvan* is commission on a bill-of-exchange (*हण्डी hundi*). *Factorage*, or the commission (of one or two pice per rupee) taken by a servant on goods bought for his master is *दस्तूरी dastūri*, or, more commonly, *फल phal*. *दलाली dalāli* is *brokerage*.

1475. *Interest* is *खर खद khāḍ*. Interest in kind, paid on seed-grain, is *आघी āghī* to the west and in South-East Tirhut. In South-West Shahabad it is *अगवान agwan*, and in Patna *खहरा chhāra* or *करहूर karhūr*. North of the Ganges generally it is also called *सवार डेही sawāi derhi*, in allusion to the rate at which the principal is lent. In the south-east it is *बिबाज biyaj*. Elsewhere *बिबाज biyaj* or *बेबाज bej* is interest on money, which in the south-east is *खर खद khāḍ*. *असल asal* or *मूर mar* is the capital lent out at interest; but in Shahabad it is also *मूल māl*, and in the south-east *खदी रुपैया khādī rūpaiya*. *मोनाफा monāpha* is profit. It is distinguished from interest (which is unlawful for them) by strict Musalmāns. Amongst others, however, the two terms are convertible. Other words for profit are *बहोत्रोरी barhotri* or *नाफा nāpha* in Shahabad, *नाफा nāpha* or *इन्तिफा intīpha* to the west, *इन्तिफा intīpha* in the south-east, and *बचिब bachit* in Patna, Gaya, and South Bhagalpur.

1476. *पैचा paincha* or *हथफेर hathpher* is a loan when the exact thing is to be returned. A local variant is *पैच painch* in South-West Shahabad. It is also called *उधार udhār*, which properly means a purchase on credit. *करजा karja* is a money loan. This is also called south of the Ganges *करज karj*, *करजवान karjavān*, and *पैचा paincha*. *दस्तगर्दानी dasgardān* or (amongst the educated) *दस्तगर्दानी dastgardān* is a temporary loan without interest. *हथफेर hathpher* or (in Shahabad) *हथ उधार hanth udhār* is also used in this sense.

1477. A *debtor* is *खदुका khaduka* or *असामी asāmi*. Local names are *खदुका khaduk* in Gaya and the south-west, *मुजेरा mujera* in Patna, and *खतब khātab* in South Bhagalpur. A defaulting debtor is *अनामार*

jamāmār, also *थानमार thanmār* in Champāran and South-East Tirhut, *मलममार malmār* in South-West Tirhut, and *थैलीमार thailimār* in South Bhagalpur. Other names are *खाज khāu* in Saran, *खौकार khaukār* in South-East Tirhut, and *ना देहन na dehan* in Patna. The educated say *ना देहान na dehand*. *Outstandings* are *लाहना lahna*. A *bad debt* is *गताल खाना gatāl khāta* in Patna and the north-west, and *गयाल खाना gayāl khāta* in Gaya and the south-west, of which *गैल खाना gail khāta* in South Munger is a variant. In South-West Shahabad it is also said to be *गपनाल gaptāl*, in Tirhut they say *बुरल भेले bural bhelai*, and in South Bhagalpur *दुबो गेले dūbo gelai*. When an animal or other property is *pledged for a debt*, it is called to the north-west and in West Tirhut *लावान lāwan* or *लावान जावन lāwan jhāwan*. Elsewhere it is *भरना bharna* or *जिरों giron*.

1478. To borrow money is *सूद पर रुपैया कारहाब (or कारहि लेब, or कारहि जाग्रब) sūd par rupaiya kārhab (or kārhi leb, or kārhi jāēb)*.

CHAPTER IV.—RATES OF INTEREST.

1479. A rate of interest is *दर dar*. The following are the rates of interest charged. Interest at one per cent. is *रुपै सेकन्दा rupai saikra*, at two per cent., *दू रुपै सेकन्दा du rupai saikra*, and so on:—

- (1) *देहा derha*, *देओहा deorha*, or in the south-east *देउहिवा deurhiya*. This is fifty per cent., *e.g.*, a man borrows five maunds of grain at sowing time and repays $7\frac{1}{2}$ maunds at harvest, without reference to the selling price at the time of borrowing or repayment. This is confined to transactions in grain.
- (2) *सवार sawāi* or *सवैया sawaiya* is twenty-five per cent. as above.
- (3) *बिकरी के भाव bikri ke bhāo* (north), or *भाव के भाव bhāo ke bhāo* (south), also *असल के असल asal ke asal* in the south-east.—In this grain is lent, and at harvest time an equivalent in grain to the real money value of the grain lent at the time of borrowing is returned.
- (4) *लगानी lagāni* is giving one rupee's worth of grain and after six months receiving back one rupee two annas worth. In South Tirhut it is also called *अठरावनी athrahni*.

- (5) पैसे रुपयेचा *paise rupaiya* is money interest at one pice per rupee per month. So उदर पैसे रुपयेचा *derh paise rupaiya* is one and a half pice per rupee per month.
- (6) टक्की *takhi* is money interest at two pice or one टका *taka* per rupee per mensem. In the south-east it is also called चरचन्नी *adhanni*.
- (7) गॅन्धी *gandhi* is money interest at four pice per rupee per month.
- (8) चरचन्नी *charanni* is four annas per rupee per annum.
- (9) पचचन्नी *pachanni* is five annas per rupee per annum.
- (10) षडचन्नी *chawanni* is six annas per rupee per annum.
- (11) कित *kist* or कित बन्दी *kist bandi* is when the total of principal and interest is repayed within a stated time by fixed instalments.

1480. The first money received by a shopkeeper during the day is बोहनी *bohni*; also बौहनी बट्टा *bohni batta* in Patna and Gaya, and बन्हाइर *banhāi* in South Bhagalpur. In Patna City it is गँडौट *ganthaut* or गँठा *gānthā*. A pledge or deposit is गिरौ *giroū* or बन्धिक *bandhik*. In Patna, Gaya, and South Munger it is गिरौनी *girwānī*, in Shahabad गिरौ *girāi*, in the south-west of that district गिरौ गँठ *giroū-gānth*, and in South Bhagalpur गिरमौ *girmi*. पुरिया *puriya*, or in East Tirhut पुरजा *purja*, is a sealed or fastened-up deposit. जाकर *jākar* is goods which are taken away for use, if required, at a wedding, &c. The price is fixed before hand. If the goods are used, this is paid; if they are not used, they are returned, and a pice or two per rupee is paid to the shopkeeper.

CHAPTER V.—MORTGAGE.

1481. A pawn or mortgage is रेहन *rehan*, बन्धिक *bandhik*, or मकफूल *makphūl*. It is also गिरौ *girāi* in Shahabad, and गिरमौ *girmi* in South Bhagalpur. मकफूल *makphūl* is more usually applied to mortgage of land, and the other terms to pawning of moveable articles; but this distinction is not universal. A mortgagor is राहिन *rahin*, and a mortgagee is मुरतकिन *murtakin*, but these words are seldom used. The villagers prefer to use words like खडुका *khaduka*, खडुक *khadduk*, or

बदाजी *asāmi* for the former, and बदाजन *mahājan* for the latter. In Patna a mortgagor is मुजेरा *mujera*, and in Shahabad a mortgagee is बेवहरिया *beohariya*.

1482. A *usufructuary mortgage*, in which both the principal and interest are extinguished by being paid out of the profits of the land mortgaged for a fixed period, is पटौचा *pataua*, सटौचा पटौचा *sataua pataua*, or सधौचा पटौचा *sadhaua pataua*. छद्द भरना *sūd bharna* is similar, but the usufruct is only instead of interest, the principal remaining to be paid by the mortgagor. A बै बिल वफा (بيع بالرضا) *bai bil wafa* is a mortgage of property for a fixed period, in which, if the total debt is not repaid within the period, the property becomes the mortgagee's in satisfaction of the debt. Money advanced on the security of standing crops is to the north लागी *lāgi*.

CHAPTER VI.—MISCELLANEOUS.

1483. An *invoice* or *manifest* is बीजक *biyak*, and also to the east चिट्ठा *chittha* or फिरिख *phirist*. *Insurance* is बीमा *bima*, with a variant बीवा *biwa* in Shahabad. In the south-west of the latter district it is हुन्दा बारा *hunda bhāra*. Something additional given to a purchaser is north of the Ganges बहूचा *ghalua* or लभ लभ *lābh sabb*. In South-East Tirhut it is also लभ *lābh*, and in South-West Tirhut बरकत *barkat*. South of the Ganges it is generally फाव *phāo* or पिछुचा *pichhua*. A variant of the latter is पछुचा *pachhua* in the south-east. Another name is चुटकी *chutki* in Patna. जूग *jūg* is similarly used by women when making petty purchases, especially of vermilion (सेनुर *senur*) and collyrium (मिस्सी *missi*). Other names for this are मंगनी *mangni* to the west and in South Tirhut, मंगनी मंगनी *mangni changni* in Patna, लावा घोली *lāwa gholi* north of the Ganges generally, लावा दूचा *lāwa dūa* in South-West Tirhut, and दांटी *dānti*. बेदाना *bedna* or बयाना *bayāna* is a *handsel* given by the buyer to the seller to secure his purchase.

1484. गद्दा *galla* is a hole in the ground or a bag under the shop-keeper's seat in which he keeps his money. To *test coin* is बूझब *būjhab*, ठोकब *thokab*, परखब *parkhab*, जाँचब *jānchab*, बजाअब *bajāəb*, or अंकनब *anknab*. In the south-east it is परेखब *parekhab*. A *money-tester* is परखी *parkhi* or परखिया *parakhiya*, or जचुचैया *jachucaiya*. In the south-east he is परेखिया *parekhiya*. In Patna he is परिख *parikh*,

and in Gaya रोकरीया *rokariya*. To test the correctness of scales is चाव लेव *sādh leb*. In Patna and the south-east it is धारा करव *dhāra karab*, and in Shahabad पासँघ देखल *pāsangh dekhāl*. To test a weight is तारव *tārab* or चावव *sādhāb*.

1485. *Capital* is पूंजी *pūñji* or पुंजी *punji*, and capital out at interest is बिबाजू *biyāju* or बेबाजू *beāju*. It is also called सूदी रुपैया *sūdi rupaiya*. The adjustment of accounts is बुभारथ *bujhārath* north of the Ganges, and सफाई *saphāi* south of it. In South-West Shahabad it is बुभौता *bujhauta*. To test the entries is जाँच लेव *jānch leb* or मिहा लेव *mila leb*. The testing is in Shahabad जाँच मिलान *jānch milān*. A release in full is फारखती *phārkhatti* or फरखती *pharkatti*. In the north-west they say in such a case हसन्तान हो गेल *bhubhtān ho gail*, and in the east of Tirhut they say his account is राफ साफ *rāph sāph*, and in Patna that it is बेबाक भैल *bebāk bhail*. In Patna they say बही पर से नाम उतर गेल *bahī par se nām utar gel*, and in South-West Shahabad नाम घेरल गेल *nām gheral gail*, alluding to the custom of encircling the name with a line when the account is cleared off.

1486. To become *bankrupt* is दिवाला निकसव *diwāla niksab*, or दिवाला सुध हो जायव *diwāla sudh ho jāēb*. To make a man a bankrupt is दिवाला निकसव *diwāla nikāsab*. A bankrupt is दिवालिवा *diwāliya*. In Tirhut they would say of such a man साक उखड़ गेलैन्हि *sāk ukhar gelainhi*, or दिवाला उखड़ि गेलैन्हि *diwāla ukhari gelainhi*. In all the above the word may also be spelt देवाला *dewāla*. In Patna they say ओकर टाट उलटल है *okar tāt ultal hai*, in allusion to the custom amongst bankers of a bankrupt turning up one corner of his mat and sitting on it, as a notice of his condition. The action is equivalent to putting up the shutters in England. In connection with this it may be mentioned that Patna is famous for its bankrupts, as in the lines commemorating the three rascals of Bihār :—

भागलपुर के भगेलिया, काहागँव के थग,
पटना के दिवालिवा, तीनों नामजद,
सुने पावे च्छप्राहिया, तीनों के तूरे रग.

*Bhāgalpūr ke Bhageliya, Kahalgāw ke thag,
Patna ke diwāliya, tino nāmjad,
Sune pāwe Chhāprahiya, tino ke tūre rag.*

—The Bhagels of Bhagalpur, the thags of Colgong, the bankrupts of Patna, are all famous (sharpers); but if a man of Chhapra hears this, he will beat them (*lit.* burst their veins) all (at their own weapons).

1487. A *bill of exchange* is डकी *hundi* or डकी पत्रो *hundi patri*; also in Gaya and the south-west पत्रो *patri*. The duplicate of the bill is पैठ *paith*. Also, in Patna City, पैठ *paith*. The third duplicate is परपैठ *parpainth* or परपैठ *parpeth*, and the fourth जिक्करी *jikri* or जिगरी *jigri*. This last is also a letter to a person other than the drawer for the acceptance of his endorsement by the drawer. A *letter of advice* is सवाचारी चिट्ठी *samāchāri chitthi*. A *bill payable at sight* is दरन्सनी *darsani*. In Patna such bills by custom bear eleven days' date. If payable after a future date, it is मिजारी *miyāri* or मुदती *mudati*. One payable five days after sight is called पञ्च परन्नाम *pahunch parmān* or (in Patna City) पञ्चै दाम *pahunche dām*. The *address* at the head of a banker's letter is जोग *jog* or चिरन्नामा *sirnāma*. A bill paid and discharged is खोका *khokha*. In Patna it is also बुहन्नाम *bhugtān*, and north of the Ganges बुहन्नाम *bhubhtān*. To *accept* a bill is सकारण *sakārab*. The date on which a bill falls due is called मिती *mitti*, which indeed in mercantile transactions is the general word for dates of all kinds.

1488. A *warehouse* is गोदाम *godām*. चरन्ना *harja* is *demurrage*. महसूल *mahsūl* or मासूल *māsūl* is *customs, postage, or railway freight, &c.* A *price-current* is निरख नामा *nirakh nāma*. *Cash or specie* is नगद *nagad*, नगदा नगदी *nagda nagdi*, or रोक *rok*. पावन्ना *pāvna* is a *claim*, and रसीद *rasid* a *receipt* डकन्ना *taksāi* is a *mint*. *Merchandise* is सोदागरी के मास *saudāgri ke māś*. *Imports* are आगन्दी *āmdāni*, and *exports* रफ्तानी *raḥtāni*.

DIVISION XIV.

WEIGHTS AND MEASURES.

CHAPTER I.—MEASURES OF LENGTH.

1489. The अङ्गुल *angul* is a finger-breadth, equal to about two-thirds of an inch. The width of the four fingers of one hand, *i.e.*, four अङ्गुल *angul*, is called a चौचा *chaua*. Instead of this, a measure is used in Shahabad called मुट्ठा *muttha*, which is the width of the closed fist. Twelve finger-breadths make one span, which is बिना *bitta* or बिलस्ता *bilasta*, or to the north-east बिलहस्त *bilhast*, to the south-east बिलहस्त *bilast*. South of the Ganges a still smaller scale is current. A सूत *sūt* is the thickness of thread.

3 सूत *sūt* = 1 पैना *pain*.

3 पैना *pain* = 1 finger-breadth.

1490. In Shahabad and the south-east a finger-breadth is तस्सुर *tassur*. In Shahabad and Patna in measuring wood, however, a तस्सुर *tassur* equals two finger-breadths, and fourteen of these make one गज *gaj* or हाथ *hāth* (wood measure). Twenty-four finger-breadths, or six चौचा *chaua*, or two बिना *bitta*, make one हाँथ *hānth* or हाथ *hāth*, which is a cubit. The हाथ *hāth* is the standard from which the others are taken, and varies from 15 to 20 inches in length, 18 inches being the average.

1491. Two cubits make one डेग *deg* or pace, and also one गज *gaj* or yard. A गिरह *girah*, गिरेह *gireh*, or गिरे *gire* is the length of the forefinger, and 16 go to a गज *gaj*. Another name for a गिरह *girah* is काननी *kanwān* in Patna and Gaya. Three गज *gai* or six cubits make one लग्गा *lagga* or लग्गी *laggi*, which is also called बाँस *bāns*

south of the Ganges, and लट्ठा *lattha* in South-West Shahabad. Another गज *gaj* is the सिक्न्दरी गज *Sikandri gaj*, also called बरा गज *bara gaj* or बरुका गज *barka gaj*, which is $2\frac{1}{2}$ cubits north of the Ganges and 48 fingers or 2 cubits south of it. It was the yard used in land measuring until Akbar's time, and properly equals 26 inches, but has become in the village mind confused with the बरा गज *bara gaj*. This is the tailor's yard, and is called by them कतरा गज *katai gaj* or कत्ती गज *katti gaj*. Akbar introduced as the standard measure of the empire the इलाही गज *ilahi gaj*, equal to $33\frac{1}{2}$ inches, which is still in use in the North-West Provinces.

1492. In South-East Tirhut and Patna धाप *dhāp* equals डेग *deg* or कदम *kadam*, a pace, but elsewhere north of the Ganges and in the south-east it is about half a कोस *kos*; see below. Another name of this last is मैल *mail* or मील *mīl*, a corruption of the English 'mile.' The रस्सी *rassi* or रसरी *rasri* is equal to 20 लग्गी *laggi* or 120 cubits. In South-West Shahabad 70 cubits make a रस्सी *rassi*. Generally 60 रस्सी *rassi* make one कोस *kos*, but in South-West Shahabad it is 50 रस्सी *rassi*. The कोस *kos* varies greatly in length in different districts. An ordinary कोस *kos* is however 60 रस्सी *rassi*, 1,200 लग्गी *laggi*, or 3,600 गज *gaj* or yards, or 80 yards more than two miles. The गौकोस *gaukos* is a vague measure of distance, as far as a cow's bellow can be heard. A कच्चा कोस *kachcha kos* is a short कोस *kos*, and धाप *dhāp* (see above) is generally about a mile.

1493. A cubit used in measuring earthwork and well-sinking is तरा *tarha* to the north-west and खनि *khanit* (literally, digging) in the south-west. In South-West Shahabad and South-East Tirhut it is खन्ता *khanta*. In Gaya it is तररा *tarra*, and to the south-east गिलदजी *gilandāji* (which means simply earth-work). In digging a well the depth is measured in men's heights, called पुरिष *puris*, &c. See § 923.

1494. The following table shows the relative value of the principal measures of length.

CHAPTER II.—SUPERFICIAL MEASURE.

1495. The पक्का बिगन्हा *pakka bigha* is fixed at 14,400 square feet, or 1,600 square yards. It is therefore a little less than $\frac{1}{4}$ of the English acre of 4,840 square yards. The कच्चा बिगन्हा *kachcha bigha* varies in every *pargana*; it is generally smaller than, but is sometimes larger than, the standard. The foundation of the size of the *bigha* is the लग्गी *laggi* (see above, § 1491), which varies greatly in the number of cubits which it contains. A square लग्गी *laggi* is a दूर *dhūr*. Twenty दूर *dhūr* make one कट्ठा *kattha*, and 20 कट्ठा *kattha* make one बिगन्हा *bigha*. In Shahabad a कट्ठा *kattha* is called a बिसुवा *bisua*. In East Tirhut a बिगन्हा *bigha* is also called कूरो *kūro*. North of the Ganges 4 पार *pāi* make one दूर *dhūr*; south of it—

9 square चौथा *chaua* make 1 sq. डेग *deg* or कदम *sadam*.

9 „ डेग „ 1 sq. दूर *dhūr*.

CHAPTER III.—MEASURES OF PROPORTION.

1496. Proportion is generally expressed by saying so many annas in the rupee. Thus 10 annas in the rupee = 10 : 16; 4 annas in the rupee = 1 : 4; 8 annas in the rupee = 1 : 2; and so on. In calculating proportionate shares in estates, two systems are in vogue. In both the estate (मौजा *mauja* or महाल *mahāl*) is the unit. In one system the following is the scale:—

1 मौजा *mauja* or महाल *mahāl* = 16 आना *āna*.

1 आना *āna* = 20 दाम *dām*.

1 दाम *dām* = 20 कौड़ी *kauri*.

1 कौड़ी *kauri* = 20 बौड़ी *bauri*.

1 बौड़ी *bauri* = 20 फौड़ी *phauri*.

1 फौड़ी *phauri* = 20 रौड़ी *rauri*.

The other system is as follows:—

1 मौजा *mauja* or महाल *mahāl* = 16 आना *āna*.

1 आना *āna* = 12 पार *pāi*.

1 पार *pāi* = 20 करंत *karānt*.

1 करंत *karānt* = 20 मसंत *masānt*.

1 मसंत *masānt* = 20 डिस्मिल *dismil* (P = decimal).

1 डिस्मिल *dismil* = 20 बिस्मिल *bismil*.

The first system is called the Hindūstāni, and the second the English system.

CHAPTER IV.—MEASURES OF WEIGHT.

1497. 25 दाम *dām* are counted to the pice (पैसा *paisa*). A दमन्दी *damri* is a nominal coin equal to $3\frac{1}{2}$ दाम *dām*. The अद्दी *addhi* is half a दमन्दी *damri*. The टक्का *takka* or टका *taka* = 50 दाम *dām* or two pice, and the अवेहा *adhela* or (in South-West Shahabad) अवेहना *adhelcha*, is $12\frac{1}{2}$ दाम *dām*, or half a pice. The दोकड़ा or दोकरा *dokra* or चहाम *chhadām* is $6\frac{1}{2}$ दाम *dām*, or $\frac{1}{2}$ of a pice. A pice is also called डेबुवा *dhebua* or (in Gaya) कच्चा *kachcha*. The चहाम *chhadām* or sixteenth part of an *āna* is also called कानवरी *kanwari*, कानवाँ *kanwān*, or चहानक *chhatānk*. The following table will make this clear :—

| | | | | | | |
|------|--------|----------|---------|----------------|-------|-------------|
| Dām. | 31 | 61 | 121 | 25 | 50 | 100 |
| | Damri. | 2 | 4 | 8 | 16 | 32 |
| | | Chhadām. | 2 | 4 | 8 | 16 |
| | | | Adhela. | 2 | 4 | 8 |
| | | | | Paisa or pice. | 2 | 4 |
| | | | | | Taka. | 2 |
| | | | | | | Āna or āna. |

1498. In weighing, the रत्ती *ratti* of 1·875 grains Troy is taken as the standard. From this the following scheme may be drawn up :—

| | |
|---|--|
| 8 रत्ती <i>ratti</i> | = 1 माषा <i>māsa</i> = 15 grains Troy. |
| 12 माषा <i>māsa</i> | = 1 तोला <i>tola</i> = 7 dwt. 12 grains Troy or the weight of one rupee. |
| 5 तोला <i>tola</i> | = 1 कनवाँ <i>kanvān</i> or चहाँक <i>chhatānk</i> = 1oz. 17 dwt. 12 grains Troy. |
| 16 कनवाँ <i>kanvān</i> or चहाँक <i>chhatānk</i> | = 1 सेर <i>ser</i> = 2lb. 6 oz. Troy. |
| 40 सेर <i>ser</i> | = 1 मन <i>man</i> = 100lb. Troy = 82·286lb. Avoirdupois. This is the standard मन <i>man</i> or maund, and 27·222 of these go to the English ton. |

For larger weights the सेर *ser* is the standard. In local bazārs it varies greatly, not only according to locality, but according to goods sold. The bazār सेर *ser* is named as containing so many गन्दा *ganda*, a गन्दा *ganda* consisting of four तोला *tola* or sometimes four pice, and being a constant quantity.

1499. In weighing gold, jewels, &c., the standard is the red seed (*abrus precatorius*) called the करन्जनी *karjani*, लाल *lāl*, or कच्ची रत्ती *kachchi ratti*. It is said to weigh three barleycorns (जौ *jau*).

The jeweller's scale is as follows :—

| | |
|---|---|
| 3 जौ <i>jau</i> | = 1 लाल <i>lāl</i> . |
| 4 ditto | = 1 रत्ती <i>ratti</i> . |
| 2 लाल <i>lāl</i> | = 1½ रत्ती <i>ratti</i> . |
| 4 रत्ती <i>ratti</i> | = 1 चौरत्ती <i>chauratti</i> . |
| 5½ ditto | = 1 षष्ठी <i>anni</i> . |
| 8 ditto | = 1 माषा <i>māsa</i> , मससा <i>masa</i> , or मसिका <i>masika</i> = 15 grs. Troy. |
| 10½ ditto | = 1 दुषष्ठी <i>duanni</i> . |
| 8 दुषष्ठी <i>duanni</i> or 10½ माषा <i>māsa</i> | = 1 धक <i>dhak</i> or (in South-West Shahabad) डाका <i>dhāka</i> , which is the weight of a rupee = 6 dwts. 6½ grs. Troy. |
| 12 माषा <i>māsa</i> | = 1 तोला <i>tola</i> = 7 dwts. 12 grs. Troy. Here it will be seen that the jeweller's rupee is less than a tola. |

1500. The following weights are common throughout Bihār :—

चटङ्की *chhatanki* = $\frac{1}{8}$ of a *ser*.

अधन्परि *adhpari*, अधन्पाज *adhpaü*, or अधन्पौषा *adhpausa* = $\frac{1}{2}$ of a *ser*
पाव *pāv*, पावा *pāva*, or पौषा *paua* = $\frac{1}{4}$ of a *ser*.

अधन्सेरा *adhsera* or असेरा *asra* = $\frac{1}{2}$ a *ser*.

तिन्पौषा *tinpausa* = $\frac{1}{4}$ of a *ser*.

सवैया *sawaiya*, properly $1\frac{1}{2}$ *ser* ; really $\frac{1}{2}$ of a पसेरी *paseri*.

देहन्सेर *derhseri* = $1\frac{1}{2}$ *ser*.

अहा *arha*, अहैया *arhaiya*, properly $2\frac{1}{2}$ *ser* ; really $\frac{1}{2}$ of a पसेरी *paseri*.

तिन्सेरा *tinsera* or तिन्सेरी *tinseri* = 3 *ser*.

चरन्सेरा *charsera* or चरन्सेरी *charseri* = 4 *ser*.

पसेरी *paseri*, also (in Shahabad) पन्सेरा *pansera*, or पन्सेरी *panseri*.

This is properly 5 *ser*, but varies greatly. It is usually said to be 7 *ser kachcha*, but is sometimes only 5 or 6. Vegetable-sellers generally call it 6 *ser*.

धारा *dhāra* = 10 *ser*. In Shahabad it sometimes means 5 *ser*.

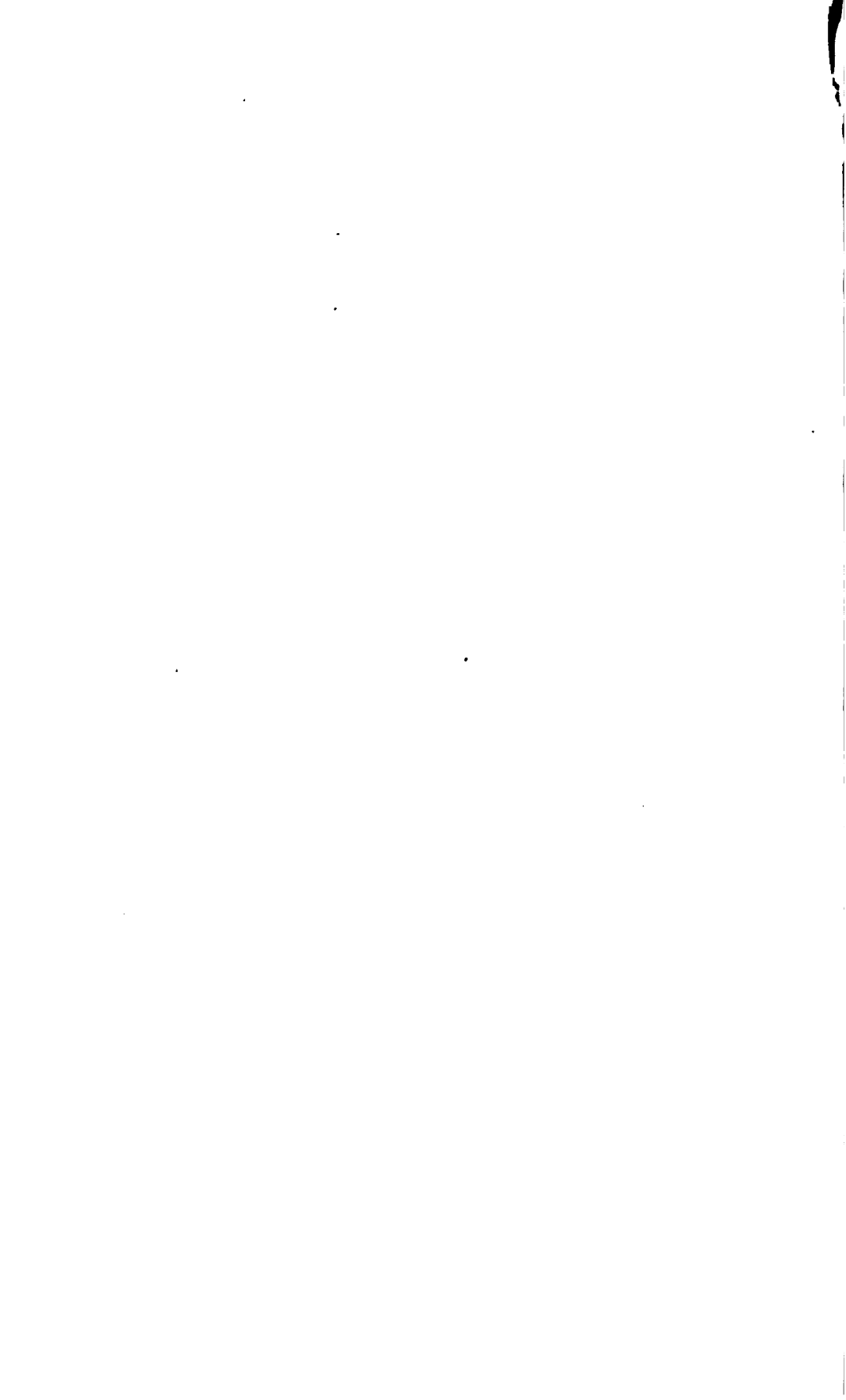

APPENDIX.

FORMS OF ACCOUNTS USED IN A LANDLORD'S OFFICE IN PATNA.

1.

खसरा दानाबन्दी *Khasra Dānābandi.*

YEAR.—

Khasra Dānābandi of the

Crop in the Estate of

DATE.—

| Name of tenant. | Length. | Breadth. | Area of plot. | Kind of crop. | Amount of crop estimated. |
|-----------------|---------|----------|---------------|---------------|---------------------------|
| | | | | | |

1a.

तिरिज बारीखवार *Tirij Tārikhwār.*

YEAR.—

Tirij Tārikhwār of the Khasra Dānābandi of Village

| Date. | Total area of crop estimated. | Total amount of crop estimated. |
|-------|-------------------------------|---------------------------------|
| | | |

2.

खसरा बटार *Khasra Batāi*.

YEAR.—

*Khasra of Division of**Crop in the Estate of*

DATE.—

| Name of tenant. | Area. | Kind of crop. | Amount of grain. | Landlord's share. | <i>Dahiyak</i> .* | <i>Pansera</i> .† | Total of columns 5 to 7. |
|-----------------|-------|---------------|------------------|-------------------|-------------------|-------------------|--------------------------|
| | | | | | | | |

2a.

Abstract of the above.

| | | | | | |
|--|-----|-----|-----|-----|---|
| (1) Date ... | ... | ... | ... | ... | } In the original, the columns run across the page instead of from top to bottom. |
| (2) Area ... | ... | ... | ... | ... | |
| (3) Total amount of grain | ... | ... | ... | ... | |
| (4) Landlord's share | ... | ... | ... | ... | |
| (5) दहिदक <i>dahiyak</i> * | ... | ... | ... | ... | |
| (6) पनखेरा <i>pansera</i> † | ... | ... | ... | ... | |
| (7) Total ... | ... | ... | ... | ... | |
| (8) सोनारी <i>sonari</i> (weighman's fees) | ... | ... | ... | ... | |
| (9) गणु पफाज <i>ganj apkhud</i> ‡ | ... | ... | ... | ... | |
| (10) बढो <i>barhi</i> § | ... | ... | ... | ... | |
| (11) सद्धो <i>saddhi</i> | ... | ... | ... | ... | |
| (12) Total | ... | ... | ... | ... | |

* *Vide* foot note to form (5).† After the division of crop, *dahiyak* is added to the landlord's share, to which again 5 seers are added, that quantity being taken from the tenant's share under the name of *pansera*.

‡ Grain found in excess at the time of second weighment on the floor after the grain has been taken over by the landlord.

§ Grain found in excess at the time of third weighment, when the grain has been carried to the landlord's granary.

|| Grain found in excess owing to swelling, &c., when the whole amount of grain stored has been sold off.

3.

मोफरोद Mophrid.

YEAR.—

*Mophrid of the Rent in Kind for the**Crop.*

NAME OF TENANT.—

Black Paddy.

| Date of Estimate. | Area. | Amount of Crop. |
|-------------------|-------|-----------------|
| | | |

Paddy Sown Broadcast.

| Date of Estimate. | Area. | Amount of Crop. |
|-------------------|-------|-----------------|
| | | |

Bāsmatti Paddy.

| Date of Estimate. | Area. | Amount of Crop. |
|-------------------|-------|-----------------|
| | | |

and so on for every kind of grain in the tenant's holding.

| Total Area. | Total Amount of Grain. |
|-------------|------------------------|
| | |

3a.

Abstract of the last.

YEAR.—

| Name of Tenant. | Total Area. | Amount of Crop. |
|-----------------|-------------|-----------------|
| | | |

4.

उपनिब *Laggit* and वाचिब बाकी *Wasil Baki*.

YEAR.—

Laggit of Rents Paid in Kind for the Whole Year.

NAME OF TENANT.—

| Kind of grain. | Area. | Total grain. | Share of landlord. | <i>Dakiyak</i> .* | Total due. | Realized. | Balance. |
|----------------|-------|--------------|--------------------|-------------------|------------|-----------|----------|
| | | | | | | | |

* See note to form 5.

APPENDIX.

v

4a.

Abstract of the last.

YEAR.—

Black Paddy.

| Name of Tenant. | Area. | Amount due. |
|-----------------|-------|-------------|
| | | |

White Paddy.

| Name of Tenant. | Area. | Amount due. |
|-----------------|-------|-------------|
| | | |

and so on for each kind of grain.

5.

तिरिज जिमिस्वार *Tirij Jimiswār.*

YEAR.—

Tirij Jimiswār for the Village of

1. Name of tenant.
2. Area under cultivation.
3. Grain due.
4. *Dahiyak*.*
5. Total.
6. Amount of maize.
7. Ditto of *marua*.
8. Ditto of *sāthi* paddy.

And so on, a separate column being allotted to each crop.

In the original, the form runs across the page in columns, and not from top to bottom.

* This is the amount the landlord receives in addition to his half share. South of the Ganges he generally realizes 5 *ser* per *man*, i.e. he receives 9 *ser* in every 16 *ser*, the tenant's share being 7 *ser*. This division of crop is called "नौसत्ता *nauhatta*," i.e. 9—7 See § 906.

6.

दिवादा *Siyāha.*

YEAR.—

Day-book of Receipts and Disbursements of Grain.

| | | DATE.— | |
|-----------------------------|------------|--------------------------|---------|
| <i>Receipts.</i> | | <i>Disbursements.</i> | |
| | Amount. | | Amount. |
| From so and so— | | | |
| <i>Sāthi</i> paddy 5 maunds | } 7 maunds | Sent to the landlord ... | |
| Broadcast paddy ... 2 ,, | | Sold, viz. ... | |
| From so and so ... | | | |
| Total Mds. ... | _____ | Total Mds. ... | _____ |
| | | Balance Mds. ... | _____ |

6a.

Abstract of above, or अवारण्डा Awarja.

| RECEIPTS. | | EXPENDITURE. | |
|-----------|------------------|--------------|------------------|
| Date. | Amount of Grain. | Date. | Amount of Grain. |
| | | | |

7.

दिवान विकरी गला *Hisab Bikri Galla.*

YEAR.—

| Date. | Amount sold. | Rate. | Price realized. |
|-------|--------------|-------|-----------------|
| | | | |

8.

खसरा *Khasra.*

YEAR—

Khasra showing the Measurements of Lands let at Cash Rates in the Village of

DATE—

| Name of Tenant. | Length. | Breadth. | Area. | Class of Land or rate per bigha. |
|-----------------|---------|----------|-------|----------------------------------|
| | | | | |

8a.

Abstract of the above.

YEAR—

Trij Khasra showing the Measurements of Lands let at Cash Rates in the Village of

| Date. | Area. |
|-------|-------|
| | |

9.

मोफरीद *Mophrid.**Mophrid of the Lands paying Cash Rates in the Village of*

YEAR.—

NAME OF TENANT.—

At Rs. 4 per bigha.

| Date of Measurement. | Area. |
|----------------------|-------|
| | |

At Rs. 3 per bigha.

| Date of Measurement. | Area. |
|----------------------|-------|
| | |

and so on for the various rates at which the tenant holds.

9a.

Abstract of the above.

YEAR.—

Tirij Mophrid of the Lands paying Cash Rates in the Village of

| Name of Tenant. | Area held by him. | Rent. |
|-----------------|-------------------|-------|
| | | |

10.

उपनिव Laggit and वासिल-बाकी Wasil-baki.

YEAR.—

Laggit of Rents payable in Cash in the Village of

NAME OF TENANT.—

| Class of land held by him. | Area. | Rate of the class. | Rent. |
|----------------------------|-------|--------------------|-------|
| | | | |

| | | | | | |
|---|-----|-----|-----|-----|-----|
| Total rent | ... | ... | ... | ... | ... |
| Cesses... | ... | ... | ... | ... | ... |
| Value of unrealized rent in kind for the year | | | ... | ... | ... |
| Arrears of previous years | ... | ... | ... | ... | ... |
| Total demand | ... | ... | ... | ... | ... |
| Deduct realizations | ... | ... | ... | ... | ... |
| Balance to be carried to next year's account | | | ... | ... | ... |

10a.

Abstract of the above.

YEAR.—

तिरिज उमिद *Tirij Laggit of Lands paying Cash Rates in the Village of**At Rs. 4 per bigha.*

| Name of Tenant. | Area. | Rent. |
|-----------------|-------|-------|
| | | |

At Rs. 3 per bigha.

| Name of Tenant. | Area. | Rent. |
|-----------------|-------|-------|
| | | |

and so on for each rate of rent.

11.

तिरिज पडे वारी *Tirij Patewari for the Village of*

| Class of Land or Degrees of Rate. | Area. | Rate. | Rent. |
|-----------------------------------|-------|-------|-------|
| 1st class | | | |
| 2nd do. | | | |
| And so on | | | |

12.

बिनावा *Siyaha*.

YEAR.—

Day-book of Receipts and Disbursements of Cash.

DATE.—

| RECEIPTS. | | EXPENDITURE. | |
|-----------------|--------------|-----------------------------|---------|
| Name of Tenant. | Amount paid. | Description of expenditure. | Amount. |
| | | | |

BALANCE.

12a.

*Abstract of the above, or अवार्जा *Awārja*, showing Expenditure only.*

Amount sent to Landlord.

| Date. | Amount. |
|-------|---------|
| | |

Salary of Village Establishment paid.

| Date. | Amount. |
|-------|---------|
| | |

गिळान्दाजी Gilandāji Expenses (Repairs to Embankments, &c.)

| Date. | Amount. |
|-------|---------|
| | |

गरामन्दा Gardmta (Diet-money supplied to the गोरेव Gorait, who takes Money to the Landlord).

| Date. | Amount. |
|-------|---------|
| | |

and so on.

13.

बोहादकी *Molhaki*.

YEAR.—

Molhaki of Payments in Cash and Kind for the Whole Year.

NAME OF TENANT.—

| CASH PAYMENTS. | | PAYMENTS IN KIND. | |
|----------------|---------|-------------------|------------------|
| Date. | Amount. | Date. | Amount of Grain. |
| | | | |

13a.

Abstract of the above.

YEAR.—

| Name of Tenant. | Total amount paid by him in cash. | Total amount paid by him in kind. |
|-----------------|-----------------------------------|-----------------------------------|
| | | |

14.

धडा *Dhaddha*.

(In the original, the columns run across the page, instead of from top to bottom. The various cesses, &c., named are only samples, and differ in every village.)

YEAR.—

Dhaddha Wāsilbaki for the Whole Year in the Village of

Columns.

- (1) Name of tenant.
- (2) Area of holding in subheads according to rate and class.
- (3) Rent.
- (4) दुपही *duanni*.*
- (5) Weighman's fees (सोमारी *sonari*).
- (6) काह चराह *kāh charāh*.†
- (7) कोठो सोरा *kothi sora*.‡
- (8) मोटरफा *motarpha*.§
- (9) बिकारी आम *bikari am* (price of mangos).
- (10) तार *tār* (rent of toddy-palms).
- (11) Rent for *mākua* trees.
- (12) मच्छली *machhli* (fishery-dues).
- (13) Total of above.
- (14) धडा माज *batta māl*.||
- (15) धडा कम्पनी *batta kampani*.||
- (16) Road-cess.
- (17) Unrealized grain-rent.
- (18) Arrears.
- (19) Grand total of demand.
- (20) Deduct share of other landlords.
- (21) Remainder, i.e., हिस्सा खास *hissa khās* (own share).
- (22) Realized.
- (23) Balance due.
- (24) Credit, realized in excess.

* See § 1201.

† Dues for grazing cattle. All cattle, except buffaloes, are generally exempt. Each buffalo is charged at from 2 to 4 annas a year. See § 1161.

‡ Rent of a saltpetre factory.

§ Rent of houses occupied by shopkeepers, oil-men, weavers, and other non-cultivating tenants. See § 1201.

|| See § 1202. These are only charged on rent of land and on old settlements of other kinds. For instance, if a new settlement is made of toddy palms, it is made in Company's rupees, and no exchange rate is added to the rent. The addition of a rate of exchange, in fact, depends on whether the settlement is made in old coinage or in new; and according to custom, rent of land is generally settled, even at the present day, in the old coinage, but not so other rents.

जामाबंदी
Jamabandi.

Jamabandi of Village

for the Whole Year

F. S.

Note.—The order of the items has been reversed for the sake of clearness. In the original, according to native custom, the totals are written first, and under them the subsidiary items. For a similar reason imaginary figures have been written against the various items.

| | Area. | | | Demand. | |
|---|-------|-----|-----|---------|-------|
| | B. | K. | DE. | Rs. | A. P. |
| Land of 1st class, at Rs. 4 | ... | ... | ... | 800 | 0 0 |
| Ditto 2nd ditto 3 | ... | ... | ... | 2,400 | 0 0 |
| Ditto 3rd ditto 2-8 | ... | ... | ... | 1,250 | 0 0 |
| Ditto 4th ditto 2 | ... | ... | ... | 600 | 0 0 |
| And so on. | | | | | |
| Total area under cultivation | ... | ... | ... | 2,000 | 0 0 |
| Add area not under cultivation | ... | ... | ... | 100 | 0 0 |
| Total area of village | ... | ... | ... | 2,100 | 0 0 |
| Total rent-demand | ... | ... | ... | 5,450 | 0 0 |
| Add cesses (only legal ones entered here) | ... | ... | ... | 300 | 0 0 |
| जामाबंदी (i.e., miscellaneous rights, e.g., fishing-rights. Cf. § 1232) | ... | ... | ... | 250 | 0 0 |
| Total demand under jamabandi | ... | ... | ... | 6,000 | 0 0 |

जमशुकर जमशुकर.

Jamshukerch of Village

for the Whole Year F. S.

Note.—The order of items has been reversed as in No. 15, from which also the imaginary figures are carried into this form.

| DEMANDS. | | OUTGOINGS. | |
|---|-----------|---|-----------|
| Nature of Demands. | Rs. A. P. | Nature of Outgoings. | Rs. A. P. |
| Balance of arrears of previous year's <i>jama-kharach</i> — | | Realized in cash and remitted to landlord ... | 4,000 0 0 |
| (a) Principal | 300 0 0 | Ditto in kind ditto ... | 500 0 0 |
| (b) Interest thereon, and fines, &c., on defaulters in respect to it ... | 50 0 0 | Total remitted to landlord ... | 4,500 0 0 |
| Total Balance ... | 350 0 0 | Village expenses— | |
| Demand for present year— | | Salary of establishment ... | 500 0 0 |
| (a) As per <i>jama-bandis</i> | 6,000 0 0 | † <i>gilandji</i> * expenses ... | 247 0 0 |
| (b) Not in <i>jama-bandis</i> (Here are entered in detail all illegal cesses, &c., which have been excluded from the <i>jama-bandis</i>) Total, say | 400 0 0 | And so on. Total village expenses ... | |
| | | Miscellaneous expenses— | 747 0 0 |
| | | ‡ <i>paniyochet</i> | 150 0 0 |
| | | § <i>garāmīta</i> * | 3 0 0 |
| | | And so on in detail. | |
| | | Total miscellaneous expenses ... | 153 0 0 |
| | | Balance— | |
| | | With the <i>gama-kharach</i> (in hand) ... | 50 0 0 |
| | | Due from the tenants (each tenant's name in detail) ... | 1,100 0 0 |
| | | With the grain-merchants† ... | 200 0 0 |
| Total for present year ... | 6,400 0 0 | Total balance ... | 1,350 0 0 |
| GRAND TOTAL OF DEMAND ... | 6,750 0 0 | GRAND TOTAL ... | 6,750 0 0 |

* See No 12a. | † Price of water supplied by a neighbouring landlord for irrigation. | This last balance is technically called *वर्ग लगी*.

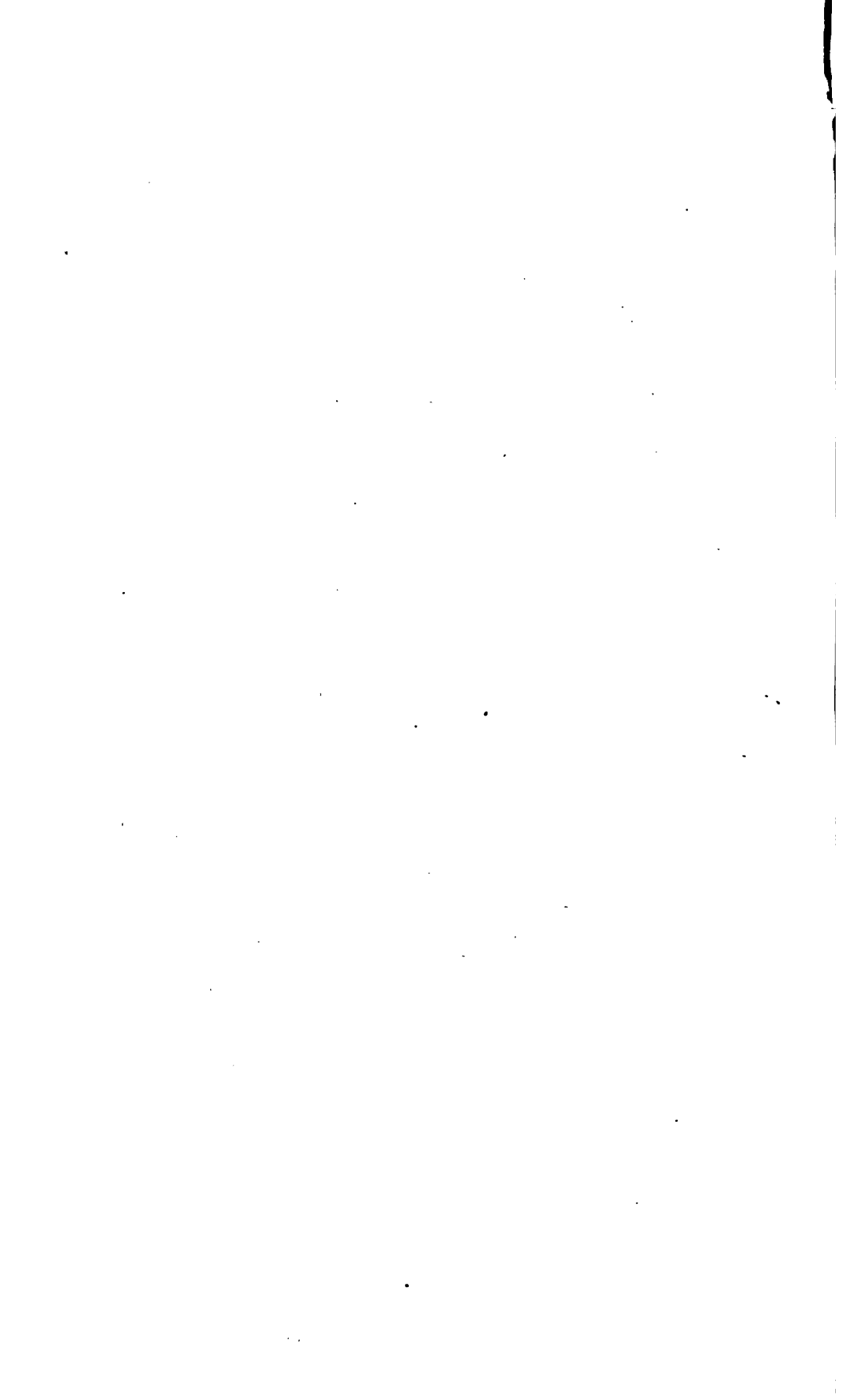

INDEX.

(The numbers refer to paragraphs.)

॥ अ a ॥

अकटा *ankta*, 1075, 1183.
 अकटा *ankra*, 794.
 अकृषी *ankri*, 794, 1183, 1266.
 अकृषील *ankrail*, 794.
 अकृषौर *ankraur*, 794.
 अकद *akad*, 1273.
 अकद सानी *akad sāni*, 1279.
 अकनब *anknab*, 1484.
 अकनरा *ankra*, 1075.
 अकनरह *akrah*, 786.
 अकरिया *ankariya*, 1118.
 अकरी *akri*, 24, 1272.
 अकरी *ankri*, 1075, 1183.
 अकवारिया *ankwariya*, 236.
 अकवार *akwār*, 886.
 अकवार *ankwār*, 886.
 अकाल *akāl*, 965a.
 अकाल गौर *akāl gir*, 965a.
 अकाल बीर *akāl bir*, 965a.
 अकाली *akāsi*, 68, 363.
 अकुरा *ankura*, 500.
 अकुरा *ankurha*, 376, 412, 414, 957.
 अकुरा *akura*, 564.
 अकुरा *ankura*, 222, 376, 414, 412,
 500, 564, 986, 1001.
 अकुराप्रह *ankurāēl*, 1009.

अकुरी *akuri*, 102, 566, 1424.
 अकुरी *ankuri*, 222, 412, 564, 877.
 अकुषा *ankusa*, 500.
 अकुषी *ankusi*, 41, 376, 500.
 अकोरा *ankora*, 32, 172, 376, 412.
 अकोल के तेल *akol ke tel*, 1045.
 अखरहवा *akharhwa*, 1086.
 अखमुंदनी *ankhmundni*, 97.
 अखरन्तिजिया *akhartijiya*, 1444.
 अखरन्तीज *akhartij*, 1444.
 अखरन्तीत *akhartit*, 1444.
 अखरहा *akhraha*, 1234.
 अखरा *akhra*, 1272.
 अखरी *akhri*, 1272.
 अखरो *akhro*, 1272.
 अखवा *ankhwa*, 1009.
 अखार *akhār*, 1039, 1082, 1083.
 अखारी *akhārhi*, 1009, 1089.
 अखारी कोरान *akhārhi koran*, 1009.
 अखिया *ankhiya*, 1009, 1010, 1376.
 अखियाब *ankhiyāy*, 1009.
 अखुषा *ankhua*, 769, 987, 1001, 1009,
 1010.
 अखुषाप्रब *ankhuāēb*, 987.
 अखुषाप्रह *ankhuāēl*, 1009.
 अखेता *akheta*, 933.

- अखेद *akhed*, 933.
 अखेना *akhena*, 76.
 अखेन *akhain*, अखेना *akhaina*, 76.
 अखेहा *akhaila*, 431.
 अखोतो *akhoto*, 933.
 अखौत *akhaut*, 611, 933, 940.
 अखौता *akhauta*, 431, 464, 611, 933,
 940.
 अँखौता *ankhauta*, 933.
 अँगँँ *angāññ*, 1203.
 अगन्करना *agkarhna*, 319k.
 अगन्का *agra*, 875.
 अगन्कौर *agraur*, 1186.
 अगन्तो *agti*, 1332.
 अगन्दाँ *agdāin*, 889.
 अगन्दाँ *aydāen*, 889.
 अगन्दाँ *agdaiññ*, 889.
 अँगन्ना *angna*, 1237, 1254.
 अँगन्ने *angnai*, 1237.
 अगन्बर *agbar*, 901, 1203.
 अँगरन्का *angarkha*, 728, 729.
 अगरन्पाठ *agarpāt*, 918.
 अगरन्बन्धु *agarbandhu*, 1010.
 अँगरन्वार *angarwār*, 281.
 अँगरन्वाह *angarwāh*, 293.
 अगन्रह *agras*, 866.
 अगन्रा *agra*, 1008, 1010, 1012.
 अँगन्रा *angra*, 1074.
 अगन्राह *agrāy*, 1089.
 अगन्री *agri*, 1250, 1252.
 अँगन्रेजी *angreji*, 504, 1263.
 अगन्रेख *agrail*, 679.
 अगन्रौटा *agrauta*, 1272.
 अगन्का *agla*, 875.
 अगन्वह *agwar*, 842, 844, 1186.
 अगन्वह जन *agwar jan*, 842..
 अगन्वह *agwarh*, 842.
 अगन्वह जन *agwarh jan*, 842.
 अगन्वन *agwan*, 1186, 1475.
 अगन्वरिया *agwariya*, 842.
 अँगन्वरिया *angwariya*, 842, 846.
 अगन्वार *agwār*, 901.
 अँगन्वार *angwār*, 842.
 अँगन्वारा *angwāra*, 846.
 अगन्वारी *agwāri*, 901.
 अगन्वाह *agwās*, 1237.
 अगन्वह *agast*, 1091.
 अगन्वन *aghan*, 1082, 1092.
 अगन्वहवा *aghanua*, 996.
 अगन्वह *agāūr*, 1186.
 अगन्वह *agār*, 113, 901, 914, 1012.
 अगन्वह *agāri*, 113.
 अगन्वह *agār*, 113, 931, 1186.
 अगन्वह *agāri*, 113, 931, 1008.
 अँगन्वह *angāri*, 288, 585.
 अगन्वह *agāh*, 655.
 अगन्वहवा *aginbāy*, 1170.
 अगन्वह *agiya*, 1075, 1170.
 अगन्वह वैताह *agiya baitāh*, 1458.
 अगन्वह *angiya*, 607, 744.
 अगन्वह *agiyāsi*, 1332, 1398.
 अगन्वह *agila*, 235 (footnote).
 अगन्वह *agua*, 558, 1286.
 अगन्वह *aguāni*, 1237.
 अगन्वह *aguār*, 1237.
 अगन्वह *aguāra*, 1237.
 अगन्वह *angutha*, 760, 772.
 अगन्वह *anguthi*, 756, 769.
 अगन्वह *agutti*, 1237.
 अगन्वह *angustāna*, 769.
 अगन्वह के ठाठ *agūt ke thāt*, 1245.
 अगन्वह *angeriha*, 292.
 अगन्वह *angetha*, 529, 567.
 अगन्वह *angethi*, 567, 1409.
 अगन्वह *agenr*, 1010, 1012, 1144.
 अगन्वह *anger*, 1008, 1012.
 अगन्वह *angerbandhu*, 1010.
 अगन्वह *angra*, 1008.
 अगन्वह *angeri*, 1010, 1012.
 अगन्वह *agela*, 363, 558.

- अंगैठा *angaiṭha*, 529, 1247.
 अंगैठी *angaiṭhi*, 1247.
 अगोरिया *agoriya*, 870.
 अंगोछा *angochha*, 733.
 अगोरनिहार *agornihār*, 870.
 अगोर बटार *agorbatāi*, 914, 1470.
 अगोरा *agora*, 870.
 अगोरी *agori*, 870.
 अगौ *agaun*, 1203.
 अगौंछा *angauñḥā*, 1203.
 अंगौछा *angauchha*, 733.
 अंगौछी *angauchhi*, 733.
 अगौड़ी *agauri*, 1186.
 अगौरी *agauri*, 844, 1186.
 अङ्कुस *ankus*, 102.
 अङ्ग *ang*, 655.
 अङ्गा *anga*, 729, 731, 972.
 अङ्गुल *angul*, 1489.
 अचकन *achkan*, 729.
 अचन्नाहर *achntāhar*, 303.
 अचन्ना *achna*, 303.
 अचन्मनी *achmani*, 774.
 अचन्रा *achra*, 741.
 अचन्रा *achra*, 741.
 अचन्री *achri*, 766, 1331.
 अचन्री पालो *añchri pālo*, 1331.
 अचार्ज *achārj*, 1347.
 अचन्वाहा *achwāha*, 303.
 अद्धा *adda*, 547.
 अचौना *anchauna*, 774.
 अचौनी *anchauni*, 774.
 अचहत *achchhat*, 1319, 1329.
 अचहा सगुन *achchha sagun*, 1454.
 अचह्वानी *achhwāni*, 1399, 1409.
 अचि *achhi*, 957.
 अचिहा *achhiya*, 1248.
 अचै तिरगिया *achhai tirtiya*, 1444.
 अजब साखार *ajab salār*, 1456.
 अजमोदा *ajmoda*, 1073.
 अजन्दारन *ajandān*, 639, 1073.
 अजान *ajān*, 969a.
 अञ्जुरी *anjuri*, 912, 1194, 1401.
 अजिचौरा *ajiaura*, 1301.
 अजू *aju*, 984.
 अजुरा *ajūra*, 1185.
 अञ्ची *anchi*, 1034.
 अञ्जुर *anjur*, 1194.
 अटका *atka*, 1183.
 अटार *atār*, 234.
 अटिया *antiya*, 862, 882, 884, 894, 982, 1194.
 अठनिया *athaniya*, 1214.
 अठनी *athanni*, 1214.
 अठमंगरा *athmangra*, 1305.
 अठमसुवा *athmasua*, 1396.
 अठमास *athmās*, 1396.
 अठराहनी *athrahni*, 1479.
 अठवारा *athwāra*, 1205.
 अठवांस *athwāns*, 1396.
 अठवांसु *athwānsu*, 1396.
 अठुली *athuli*, 1183.
 अठोतरी *athotri*, 781.
 अठोंगर *athongar*, 1323.
 अठोंगर *athaungar*, 1323.
 अठ्ठक *aṭṭhak*, 1250.
 अठ्ठ *anrar*, 1045.
 अठ्ठरी *anrri*, 1045.
 अडा *ara*, 987, 1153.
 अडा गेल *ara gel*, 987.
 अदान *arān*, 1153.
 अदानी *ardni*, 29, 216, 613, 952.
 अदर *arār*, 1147, 1153.
 अदर्रांस *arāns*, अदरांस *anrās*, 937.
 अदिवातक *ariyātak*, 1056.
 अदा *arha*, 1500.
 अदर *arhāi*, 473.
 अदर खन्ना *arhāi khamha*, 473.
 अदिहा *arhiya*, 714.
 अदेहा *arheya*, 1180.
 अदेया *arhaiya*, 713, 1180, 1500.

बडा *anā*, 48.
 बडी *anti*, 498.
 बडा *an la*, 1045.
 बडी *andi*, 1045.
 बतर *atar*, 1381.
 अंतन्ना *antra*, 1050.
 अतन्नावन *atrāwan*, 363.
 अतन्नावन भोज *atrāwan bhānj*, 363.
 अतार *atār*, 1058.
 अतीथ *atith*, 1429.
 अधन्ना *athra*, 430, 465, 506, 584,
 713.
 अधरी *athri*, 251, 253, 319a, 576,
 713.
 अधवानो *athwāni*, 579.
 अधसचन *athsanchan*, 1424.
 अदन *adant*, 1118.
 अदमी *admi*, 1217, 1274.
 अद्रक *adrak*, 1073.
 अद्रक *adrakh*, 1073.
 अद्रा *adra*, 866, 1009, 1082,
 1085, 1089.
 अद्रा के कोरनी *adra ke korni*,
 1009.
 अद्रा कोरन *adra koran*, 866.
 अद्रल *adlai*, 1461.
 अद्रल अद्रल *adlai badlai*, 1461.
 अद्ररी *advari*, 1272.
 अद्र *adr*, 1098.
 अद्ररी *adāri*, 1098.
 अधिमी *adimi*, 1274.
 अद्ररी *adauri*, 1272.
 अधधनी *adhanni*, 1479.
 अधक *adhkar*, 1214.
 अधक कित *adhkar kist*, 1214.
 अधकर *adhkar*, 372, 713, 1214.
 अधकार *adhkār*, 372.
 अधकर *adhkhar*, 1214.
 अधप *adhpai*, 1500.
 अधप *adhpakku*, 957.

अधपा *adhpatū*, 1500.
 अधपा *adhpausa*, 1500.
 अधपति *adhbatiya*, 904.
 अधपति *adhbataiya*, 904.
 अधभरी *adhbhari*, 898.
 अधरसी *adhrassi*, 1399.
 अधरी *andhri*, 1007.
 अधरी पदावन *andhri patāwan*, 1007.
 अधलपा *adhlapa*, 1190.
 अधला *adhla*, 422.
 अधला *adhla*, 1190.
 अधवा *adhwa*, 1054.
 अधसेरा *adhsera*, 1500.
 अधरी *andhāri*, 226, 1249.
 अधिकार *adhikār*, 1354.
 अधिकार माला *adhikār māla*, 1354.
 अधिया *adhiya*, 904, 1214.
 अधियारी *andhiyāri*, 97.
 अधेला *adhelcha*, 1497.
 अधेरी *andheri*, 866.
 अधेरी कोरन *andheri koran*, 866.
 अधेला *adhela*, 1497.
 अधेली *andheli*, 97.
 अधल *adhail*, 1118.
 अन् *an*, 990.
 अन्जान *anjān*, 1183.
 अन्त *anat*, 1443.
 अन्त *anant*, 754, 767, 1443.
 अन्न्द *anand*, 1085.
 अन्पट *anpat*, 97.
 अन्परासन *anprasan*, 1407.
 अन्वा *anwāh*, 845, 1097.
 अन्ज *anāj*, 1272.
 अन्ठा *anātha*, 1157.
 अन्थु *anāthu*, 379.
 अन् *andr*, 585, 977.
 अन् कली *andr kali*, 977.
 अनु *anua*, 951.
 अनुराधा *anurādhā*, 1082.
 अनेरवा *anerwa*, 1132.

- अनेरिजा *aneriya*, 1147.
 अनेर *aner*, 1132.
 अनेरा *anera*, 1147.
 अनौषा *anaua*, 951.
 अन्तर कटवा *antar katwa*, 1175.
 अन्ती *anti*, 753.
 अन्दरात *andarāt*, 1254.
 अन्न *ann*, 1272.
 अन्नी *anni*, 1499.
 अन्स *ans*, 1203.
 अन्हरिया *anhariya*, 1009.
 अन्हाव *anhāo*, 915.
 अपन्डन *aptan*, 1342.
 अपन्डा *apta*, 801, 918.
 अपन्ती *apti*, 233.
 अपन्ने *apne*, 1275.
 अप्पन *appan*, 1113, 1446.
 अप्पजूद *aphjūd*, Appendix, 2a.
 अप्पन्तावा *aphtāba*, 698, 711.
 अप्पन्तावा *aphtāya*, 698.
 अब *ab*, 1088, 1091.
 अबखोरा *abkhora*, 690, 713.
 अबन्डन *ablan*, 661, 1342.
 अबन्दा *abda*, 1076.
 अबन्रा *abra*, 739.
 अबन्वाव *abwab*, 1470.
 अबवाद *abāū*, 795, 799.
 अबवादी *abādī*, 784, 795, 799.
 अबिज्ज *abijj*, 1078.
 अबुषाव *abuab*, 1201.
 अबो *abon*, 1098.
 अब्बर *abbar*, 800.
 अब्बी *abbi*, 856, 859.
 अब्हेर *abher*, 363 (14).
 अबखोरा *amkhora*, 690.
 अमन्ता *amta*, 1183, 1456.
 अमन्ता भवान्नी *amta bhawāni*, 1456.
 अमन्दी *amdi*, 1274.
 अमन्ना *amna*, 1456.
 अमन्रोरा *amrora*, 1183.
 अमन्सा *amla*, 1255.
 अमन्सो घोटन *amlo ghotan*, 1310.
 अमन्ती *amān̄thi*, 1272.
 अमन्ती के रोटी *amān̄thi ke roti*, 1272.
 अमारो *amāri*, 852.
 अमाह *amāh*, 345.
 अमाह *amāh*, 345.
 अमावट *amāwat*, 1272.
 अमावस *amāvas*, 1088.
 अमीन *amīn*, 913.
 अमेरु *ameri*, 191.
 अमेदी *amerhi*, 169.
 अमोट *amot*, 1272.
 अम्बिका भवान्नी *ambika bhawāni*, 1456.
 अम्बित *amrit*, 1023.
 अरर *arai*, 101.
 अरन्कसिया *arkasiya*, 395.
 अरन्कीच *arkaunch*, 1272.
 अरख *arakh*, 1033.
 अरगनी *argani*, 464, 649.
 अरगेनी *argeni*, 649.
 अरग्वा *argha*, 775.
 अरज *araj*, 1470.
 अरदन्रा *aradra*, 967, 1082, 1084,
 1085, 1086.
 अरन्दाना *ardāna*, 585.
 अरन्दावा *ardāwa*, 1272.
 अरन्धी *ardhi*, 1279.
 अरन्धुवा *ardhua*, 1279.
 अरन्नी *arni*, 414.
 अरन्पन *arpan*, 1209a.
 अरन्पा *arpa*, 884.
 अरब्बी *arabbi*, 1061.
 अरन्रा *arra*, 396, 451, 792.
 अरन्वन *arwan*, 115, 376.
 अरन्वा *arwa*, 963, 1383.
 अरन्वी *arsi*, 48, 646.
 अरान्च *arānch*, 639.
 अराजी *arāji*, 1470.
 अराठ *arāth*, 940.

- अरार *arār*, 792.
 अरारि *arāri*, 792.
 अरिष्यन् *arian*, 791.
 अरुचा *arua*, 101, 1061.
 अरुई *arui*, 1061, 1272.
 अरुईया *araiya*, 1074, 1183.
 अरुईया *araua*, 33, 101.
 अर्द्धवारम् *ardwān*, 639.
 अलङ्गनी *algani*, 464, 613.
 अलङ्गारजी *algari*, 393.
 अलङ्गल *algal*, 1076.
 अलङ्गा *alga*, 875.
 अलङ्गी *algi*, 799.
 अलङ्ग *alang*, 833, 919, 953.
 अलङ्गी *alti*, 1061.
 अलङ्गिणी *alpajjiya*, 1146.
 अलङ्गी *alphi*, 475.
 अलङ्गिणी *alucanti*, 1398.
 अलावा *alāwa*, 1041.
 अलङ्गारी *ahwari*, 562.
 अलावे *alāwe*, 1041.
 अलाह *alāh*, 868.
 अलुचा *alua*, 1057, 1059.
 अलुई *alui*, 1057.
 अलुचा *alhua*, 1059.
 अलुई *awai*, 856.
 अलङ्गार *awgar*, 405.
 अलङ्ग गवन् *awan gawan*, 1294.
 अलङ्ग *amwara*, 770.
 अलङ्ग *awdē*, 26.
 अलङ्ग *awārja*, 1470, 1471, 1472;
 Appendix, 6a and 12a.
 अलङ्ग *awāl*, 345.
 अलङ्ग *añwāl*, 345.
 अलङ्ग *awālu*, 1264.
 अलङ्ग *añwāsal*, 713.
 अलङ्ग *añwānsa*, 882.
 अलङ्ग *añwānsi*, 884.
 अलङ्ग *ashtotri*, 781.
 अलङ्ग *askaldā*, 611.
 अलङ्गनी *asgani*, 649.
 अलङ्ग *asgun*, 1454.
 अलङ्गी *asthi*, 1252.
 अलङ्गान *asnān*, 1418.
 अलङ्गान करार *asnān korāeb*, 1418.
 अलङ्गी *asni*, 996, 1082.
 अलङ्गोल *asaphgol*, 1073.
 अलङ्गान *asmān*, 585.
 अलङ्गान तारा *asmān tāra*, 585.
 अलङ्गानी *asmāni*, 1043.
 अलङ्ग *asrāēb*, 25.
 अलङ्ग *osrāph*, 1217.
 अलङ्ग *asrekha*, 1087.
 अलङ्ग *asres*, 1082.
 अलङ्ग *asal*, 1475, 1479.
 अलङ्ग के अलङ्ग *asal ke asal*, 1479.
 अलङ्ग *aslekha*, 1082, 1086.
 अलङ्ग *asārḥ*, 1082.
 अलङ्गी *asārhi*, 866, 1009, 1039.
 अलङ्गी कोङ्ग *asārhi kor*, 1009.
 अलङ्गी कोङ्ग *asārhi koran*, 866.
 अलङ्गी कोङ्ग *asārhi kor*, 866.
 अलङ्गिणार *asāmiyār*, 1040.
 अलङ्गिणार *asāmiwār*, 1040.
 अलङ्गी *asāmi*, 904, 1215, 1219,
 1461, 1477, 1481.
 अलङ्ग *asār*, 25, 1265.
 अलङ्गारी *asāwari*, 1379.
 अलङ्ग *asujan*, 1354.
 अलङ्ग पत्र *asujan patr*, 1354.
 अलङ्ग *asera*, 1500.
 अलङ्गी *aseri*, 1198.
 अलङ्ग *astar*, 509, 739.
 अलङ्ग *astūra*, 383.
 अलङ्ग *astham*, 613, 1259.
 अलङ्ग *asthal*, 1234.
 अलङ्ग *asthān*, 1455.
 अलङ्गान *asmasān*, 1418, 1421.
 अलङ्गान पूजा *asmasān pūja*, 1421.
 अलङ्गिणी *aswini*, 1082.

अहुरा *ahra*, 833, 919.
 अहुरी *ahri*, 865, 833, 919.
 अहुराह *ahwah*, 1172.
 अहियाती *ahiyāti*, 1277.
 अहियाती *ahiwāti*, 1277.
 अहार *ahār*, 233.
 अहोर *ahir*, 1150, 1160.

अहोर के.गू *ahir ke ghyu*, 1160.
 अहुरा *ahura*, 1294.
 अहुरा अहुरा *ahura bahura*, 1294.
 अहुला *ahula*, 882.
 अहोर *ahor*, 1294.
 अहोर अहोर *ahor bahor*, 1294.

॥ अ a ॥

आर पाद *āi pāi*, 362a.
 आरल *āil*, 833, 1294.
 आरल गैल *āil gail*, 1294.
 आरलि *āih*, 740.
 आउर *āūr*, 904.
 आउन *āēn*, 81.
 आउल *āel*, 1234.
 आओन *āōn*, 160.
 आक *āk*, 167, 170, 172, 174, 178,
 179, 181, 183, 184, 185, 188,
 190, 191, 200, 203, 204, 221,
 222.
 आंकड़ *ānkar*, 794, 1266.
 आंकुठ *ānkuth*, 408.
 आंकुच *ānkus*, 102.
 आंख *ānkh*, 172, 1009, 1010, 1057.
 आखरी *ākhri*, 1007.
 आखा *ākha*, 128.
 आखा *ānkha*, 128.
 आंखि *ānkhī*, 1009, 1057.
 आग *āg*, 172, 1075.
 आगन्दारन *āgdāin*, 889.
 आंगन *āngan*, 1237, 1306, 1377,
 1430.
 आगर *āgar*, 1250.
 आगल *āgal*, 1250.
 आगा *āga*, 1008.
 आगी *āgi*, 1416, 1419.
 आपी देव *āgi deb*, 1416.
 आगि बैताल *āgi baitāl*, 1458.

आगि मोल लेव *āgi mol leb*, 1419.
 आगिल *āgil*, 1089.
 आंगी *āngi*, 607.
 आगू *āgu*, 1234.
 आगे *āge*, 1089.
 आपी *āghi*, 1475.
 आंघी *āngihī*, 607.
 आचन्मनी *āchmani*, 774.
 आंचर *ānchar*, 741.
 आंछी *ānchhī*, 1248.
 आंजुर *ānjur*, 912.
 आटा *āta*, 1272.
 आंटा *ānta*, 1272.
 आंटी *āntī*, 862, 864, 884, 886, 886n,
 894, 982.
 आंठिल *ānthil*, 1183.
 आंठी *ānthī*, 1272.
 आंठी के रोटी *ānthī ke roti*, 1272.
 आड़ा *āra*, 853, 1247.
 आड़क *ārhak*, 89.
 आड़ा *ārha*, 914.
 आंतर *āntar*, 838, 1050.
 आतश्बाज *ātasbāj*, 580.
 आतश्बाज *ātasbāj*, 580.
 आंती *āntī*, 1173.
 आंती चढ़ जाउव *āntī charh jāēb*,
 1173.
 आंती बहव *āntī barhab*, 1173.
 आद *ād*, 1073.
 आदमी *ādami*, 1274 (footnote).

- चारि *adi*, 1085.
 चारी *adi*, 1073.
 चादीचक *adichak*, 1063.
 चादो *ado*, 1399.
 चादो वृद्ध *ado gar*, 1399.
 चाधा *adha*, 823, 1053, 1088, 1089,
 1092, 1139.
 चाधा धोही *adha dholi*, 1053.
 चाधा फारी *adha phari*, 1139.
 चाधी *adhi*, 1087.
 चाधी रात *adhi rat*, 1087.
 चाधेचाध *adheadh*, 1214.
 चान *an*, 81, 1090, 1113, 1263.
 चाना *ana*, 81, 741, 1496.
 चापा *apa*, 646.
 चाफत *aphat*, 1080.
 चावकार *abkar*, 371.
 चावा *aba*, 732.
 चावादी *abadi*, 1183.
 चावि *abi*, 922.
 चावी *abi*, 370.
 चावी सोरा *abi sora*, 370.
 चाभा *abha*, 64, 1172.
 चाभी *abhi*, 27.
 चाम *am*, 814, 999 (footnote); Ap-
 pendix, 14.
 चाम के बगैचा *am ke bagaicha*, 814.
 चामन्दती *amdani*, 1488.
 चामिल *amil*, 1272.
 चार *ar*, 101, 414, 482, 828, 829,
 832, 833, 1147.
 चारत *arat*, 1332.
 चारन्ती *arti*, 780, 1332.
 चारन *aran*, 414.
 चारन्ची *arsi*, 48, 605, 769.
 चारा *ara*, 154, 396, 828, 836,
 1247.
 चाराबस *arakas*, 395.
 चारागज *aragaj*, 154.
 चारि *ari*, 833, 834, 865.
 चारिक *arik*, 834.
 चारि हाडन *ari chhatan*, 865.
 चारो *ari*, 396, 470, 471, 474, 583,
 828, 833.
 चारो चास *ari chas*, 828.
 चारु *aru*, 1057.
 चास *al*, 833, 1042, 1044.
 चासन *alan*, 1251.
 चालू *alu*, 1057.
 चाळो *alo*, 877.
 चाव *av*, 3.
 चावळ *ava*, 957.
 चावळ *avlat*, 1272, 1342.
 चावत *avat*, 1084.
 चावन *avan*, 160.
 चावा *ava*, 577, 1262.
 चावणी *avani*, 1262.
 चावे *ave*, 957.
 चास *as*, 1088, 1091.
 चासन्ची *asni*, 773.
 चासन्किक *asrik*, 1457.
 चासा *asa*, 1192.
 चासा चास *asa chas*, 1192.
 चासिन *asin*, 1082, 1087.
 चांसी *ansi*, 884.
 चास *ah*, 414.
 चापर *ahar*, 919, 953.
 चाऊल *ahul*, 882.

॥ इ : ॥

इकन्की *ikri*, 1266.
 इकन्की *inkri*, 794, 1266.
 इकन्नी *ikri*, 815, 1050.

इकर *ikkar*, 815.
 इगन्ती *ingrauti*, 662.
 इगुरी *inguri*, 1272.

ईगुर *ingūr*, 1272.
 इजार *ijār*, 727, 743.
 इजार बन्ध *ijār band*, 743.
 इजारा *ijāra*, 1210.
 इची *inchi*, 1034.
 इतिवार *itibār*, 1451.
 ईन्द्रा *indra*, 920.
 ईंदारा *indāra*, 920.
 इन्ताषा *intāpha*, 1475.
 इन्तिषा *intipha*, 1475.
 इनाम *inām*, 1194, 1205, 1209d,
 1217.
 इनामत *ināmāt*, 1209d.
 इनार *inār*, इनारा *ināra*, 920.
 इन्सी *insi*, 1034.
 इमरिती *imriti*, 1272.
 इमलपत्ती *imalpatti*, 748.

इमली *imli*, 1310, 1314.
 इमली घोंटार *imli ghoñtāi*, 1310,
 1314.
 इमाम *imām*, 706.
 इमाम जिस्ता *imām jista*, 706.
 इमामबादा *imāmbara*, 1379.
 इमिरती *imirti*, 1073, 1272.
 इरादा *irāda*, 1465.
 इल्लाही *ilāichi*, 1272.
 इल्लाही दाना *ilāichi dāna*, 1272.
 इलाम *ilām*, 1217.
 इल्लाही *ilāhi*, 1491.
 इल्लाही गज *ilāhi gaj*, 1491.
 इस्तिरी *istiri*, 389.
 इस्तमरारी *istamrāri*, 1215.
 इस्तिरी *istiri*, 1275.
 इहै *ihai*, 1088.

॥ ई : ॥

ई i, 128 (footnote), 240, 394, 741,
 1088, 1113, 1183.
 ईकार *inkar*, 1051.
 ईगुर *ingur*, 747.
 ईंट *int*, 1263.

ईटा *ita*, 1263.
 ईंटा *inta*, 367, 1263, 1264.
 ईस *is*, 5.
 ईसान *isān*, 1087.

॥ उ u ॥

उकान्त *uktan*, 1342.
 उकान्ठा *ukthā*, 1004, 1074.
 उकान्दा *ukrha*, 1074.
 उकरी *ukri*, 564.
 उकसा *uksa*, 1074.
 उकाम *ukām*, 892.
 उकान्ध *ukāñw*, 892.
 उकुम *ukum*, 892.
 उकान्ठा *ukhthā*, 1074.
 उखड़ *ukhar*, 1486.
 उखड़ हाल *ukhar hāl*, 827.
 उखड़ा *ukhra*, 1075.

उखड़ि *ukhari*, 1486.
 उखन्धन्ना *ukhbandhna*, 120.
 उखर जाग्रब *ukhar jāēb*, 1174.
 उखरा *ukhra*, 1074.
 उखरी *ukhri*, 24, 612.
 उखली *ukhli*, 431.
 उखारी *ukhāri*, 805, 1006.
 उखाव *ukhāo*, 805.
 उखान्ध *ukhāñw*, 805, 1006.
 उखेवा *ukheva*, 919.
 उखेनो *ukhaino*, 76
 उखौता *ukhauta*, 431.

- ଉଗ *ug*, 1087.
 ଉଗାନ୍ତ *ugtan*, 1342.
 ଉଗାନ୍ତାନ *ugaldān*, 707.
 ଉଗୁ *ugui*, 1091.
 ଉଘେନ *ughen*, 115.
 ଉଚକା *uchka*, 1259.
 ଉଚକୁନ *uchkun*, 464.
 ଉଚଲି *uchli*, 792.
 ଉଚ୍ଚବର *uchwar*, 1256.
 ଉଚ୍ଚାସ *uchās*, 790.
 ଉଚ୍ଚତାନୀ *uchhtani*, 867.
 ଉଚ୍ଚାହୀ *uchhāri*, 1436.
 ଉଜା *ujar*, 796.
 ଉଜାଦ୍ଦା *ujra*, 796.
 ଉଜାରକ୍ତା *ujarka*, 1059.
 ଉଜାରକ୍ତ *ujral*, 796.
 ଉଜାରା *ujra*, 1147.
 ଉଜାଗର *ujāgar*, 965b.
 ଉଜାହ୍ *ujār*, 796.
 ଉଜ୍ଜା *ujja*, 1147.
 ଉଜ୍ଜଲନ *ujhlan*, 866, 867.
 ଉଜ୍ଜିଲ୍ଲା *ujhila*, 1272.
 ଉକ୍ତାନ *utkan*, 705, 1342.
 ଉତ୍ତରା *utra*, 193, 959.
 ଉତ୍ତା *uttha*, 842.
 ଉଥ *uth*, 1113.
 ଉତ୍ତନୀ *uthti*, 799, 1229.
 ଉତ୍ତନୀ ପରତନୀ *uthti parti*, 1229.
 ଉତ୍ତାପ୍ତ *uthaëb*, 1030, 1333.
 ଉତ୍ତାନ *uthān*, 1087, 1090, 1439.
 ଉତ୍ତାନୋ *uthāno*, 1094.
 ଉତ୍ତାବେକ *uthābaik*, 1234.
 ଉତ୍ତାମିହାର *uthaunihār*, 1030.
 ଉତ୍ତାମିହାରିନ *uthaunihārin*, 1030.
 ଉହାର *urāi*, 1320.
 ଉହାରୋକ *urāöl*, 713.
 ଉହାହ *urāhab*, 713.
 ଉହହ *urharh*, 376.
 ଉହନ୍ଦା *urhrha*, 233
 ଉହହୀ *urharhi*, 1280.
 ଉହରୀ *urhari*, 1280.
 ଉହାପ୍ତ *urhāëb*, 713.
 ଉତ୍ତର *utar*, 1485.
 ଉତ୍ତରତ *utrat*, 1085.
 ଉତ୍ତରନା *utarna*, 764.
 ଉତ୍ତରା *utra*, 1082, 1088.
 ଉତ୍ତରା ହାହ *utra khār*, 1082.
 ଉତ୍ତରା ଫଗୁନୀ *utra phaguni*, 1082.
 ଉତ୍ତରୀ *utri*, 1418.
 ଉତ୍ତରରାଗ *utsarg*, 1459.
 ଉତ୍ତାରବ *utārab*, 1420.
 ଉତ୍ତାରା *utāra*, 1457.
 ଉତ୍ତାରା ପତାରା *utāra patāra*, 1457.
 ଉତ୍ତର *uttar*, 1082.
 ଉତ୍ତର ଗହପଦ *uttar bhadrapad*, 1082.
 ଉଦଙ୍ଗର *udangar*, 1147.
 ଉଦନ୍ତ *udant*, 1118.
 ଉଦ୍ଦରାହ *udrāchh*, 755.
 ଉଦହ *udah*, 919.
 ଉଦହ କେ ପାନୀ କେ ଉପ୍ତାପ୍ତ *udah ke pāni
le jāëb*, 919.
 ଉଦୈ *udai*, 1087.
 ଉଦ୍ଧାନ *udhān*, 301.
 ଉଦ୍ଧାର *udhār*, 1476.
 ଉନ୍ତା ବିରଚିରୀ *unta chirchiri*, 1183.
 ଉନ୍ଦା *undāh*, 826.
 ଉପଙ୍ଗସ *upjay*, 1087.
 ଉପଜ୍ଜି *upaje*, 829, 1087.
 ଉପନ୍ତା *upta*, 918.
 ଉପନ୍ତାର *uptār*, 1088.
 ଉପର *upar*, 11.
 ଉପରକ୍ତର *uparkar*, 363.
 ଉପରକ୍ତହୀ *uparchhatti*, 1245.
 ଉପର ପାତୋ *upar pāto*, 11.
 ଉପରନ୍ଦାର *uparudār*, 790.
 ଉପନ୍ଦାର *uprār*, 790.
 ଉପନ୍ଦା *uprauta*, 620, 1250.
 ଉପନ୍ଦା *upraunta*, 1251.
 ଉପନ୍ଦା *uparaur*, 1113.
 ଉପାରକ୍ତ *upārjit*, 1215.

उपंजिया *uphangiya*, 844.
 उबन्तन *ubtan*, 1308, 1314, 1340,
 1342, 1368.
 उबन्धन *ubhan*, 115.
 उबहनि *ubahani*, 116, 930.
 उबहनी *ubhani*, 115.
 उबहैन *ubhain*, 115.
 उबेर *uber*, 1147.
 उबैरा *ubera*, 1147.
 उभर *ubhar*, 792.
 उभर खभर *ubhar khābhar*, 792.
 उम्मी *ummi*, 877, 990.
 उरकुस्सी *urkussi*, 1075.
 उरन्ता *urta*, 585c.
 उरन्ता पेटाहा *urta petārha*, 585c.
 उरन *uran* 585c.
 उरन पेटाहा *uran petārha*, 585c.
 उरफी *urphi*, 1361, 1363.
 उरन्ता *urma*, 748.
 उरिद *urid*, 996.

उरन्दी *urdi*, 996.
 उलन्दल *ultal*, 1486.
 उलन्टा *ulta*, 749.
 उलन्टा मुन्धा *ulta mundha*, 749.
 उलन्दी *ulti*, 475.
 उलन्दी चीन *ulti chin*, 475.
 उलन्दी *uldi*, 714.
 उलरवा *ularua*, 195.
 उलन्वा *uhua*, 1272.
 उलन्वा दास *uhua dāl*, 1272.
 उल्लँक *ulānk*, 230.
 उल्लवल *ulāwal*, 1272.
 उल्लवल दास *ulāwal dāl*, 1272.
 उष *us*, 655.
 उषन्ना *usna*, 963.
 उषन्ना, *usra*, 1242.
 उषिना *usina*, 963.
 उषठ *usath*, 800.
 उषर *ussar*, 816.

॥ ऊ ū ॥

ऊ *ū*, 568, 1088.
 ऊख *ūkh*, 1005, 1006, 1008.
 ऊख (or केतारी) के खेत *ūkh (or ketāri)*
ke khet, 1006.
 ऊखर *ūkhar*, 792.
 ऊखर खाबड़ *ūkhar khābar*, 792.
 ऊखि *ūkhi*, 1005.
 ऊगहिँ *ūgahiñ*, 1087.
 ऊगे *ūge*, 1091.
 ऊँच *ūnch*, 792, 829.
 ऊँच खाल *ūnch khāl*, 792.
 ऊँठ *ūnt*, 1131.

ऊड़े *ūre*, 1088.
 ऊना *ūna*, 828.
 ऊना डेही जोत *ūna derhi jot*, 828.
 ऊना थोही जोत *ūna dyorhi jot*, 828.
 ऊना पानी *ūna phāni*, 828.
 ऊनी *ūni*, 877, 990.
 ऊबर *ūbar*, 792.
 ऊबर खाबर *ūbar khābar*, 792.
 ऊमी *ūmi*, 877, 990, 1272.
 ऊरस *ūras*, 1441.
 ऊलुस *ūlus*, 1271.
 ऊसर *ūsar*, 816.

॥ ए e ॥

एक *ek*, 625, 817, 904, 1070, 1085,
 1118, 1234.

एकगोटिया *ekgotiya*, 639.
 एकचारा *ekchāra*, 1245.

- एकधारी *ekchāri*, 1245.
 एक चास *ek chās*, 823.
 एकधपरा *ekchhapra*, 1245.
 एकजोरिया *ekjoriya*, 639.
 एकठा *ektha*, 35, 232, 527, 538,
 705.
 एक तौल *ek taul*, 1118.
 एकपहा *ekpatta*, 730.
 एकपक्षिया *ekpaliya*, 1245.
 एकपक्षिया *ekphasila*, 803.
 एकपक्षिया *ekphasili*, 803.
 एकपक्षिया *ekbadhiya*, 639.
 एक बाँध *ek bāñh*, 817.
 एकरङ्गा *ekranga*, 1379, 1381.
 एकरी *ekri*, 1272.
 एकरी *enkri*, 1272.
 एकदार *eklāi*, 730.
 एकलौता *eklauta*, 1397.
 एकवार *ekwāi*, 524, 531, 549.
 एकपक्षिया *eksaliya*, 803.
 एक साल के तौल, *ek sāl ke taul*, 1118.
 एकसिङ्गा *eksingha*, 1108.
 एकपत्तू *ekhatthu*, 510.
 एकपत्तू भाची *ekhatthu bhāthi*, 510.
 एकधन्वी *ekhanthi*, 414.
 एक हरा *ek hara*, 31.
 एकहरा *ekahra*, 1250.
 एकहुला *ekahula*, 1397.
 एकधे *ekābe*, 524.
 एकधिया *ekaisiya*, 884.
 एकैसी *ekaisi*, 884, 885.
 एकौ *eko*, 1090.
 एकौनिचाँ *ekauniyañ*, 1397.
 एकौन *ekaunj*, 1398.
 एकौला *ekaulha*, 1247.
 एका *ekka*, 148, 228.
 एके *ekke*, 964.
 एकराजात *ekhrājāt*, 1207.
 एगदौँ *egdāin*, 889.
 एगना *engna*, 1237.
 एघाय *eghāy*, 952.
 एघाँ *eghānw*, 951, 952.
 एघावा *eghāwa*, 952.
 एतेक *etek*, 1451.
 एदली *edli*, 967a.
 एह *eh*, 1088.
 एधवाती *ehwāti*, 1277.
 एधि *ehi*, 1002 (footnote), 1113.

॥ ए e ॥

एक *ek*, 1084.| एरा *era*, 29, 89, 185, 195.

॥ ऐ ai ॥

ऐँठुआ *ainthua*, 756, 769.| ऐरुआ *airha*, 726.

॥ ऐ ai ॥

ऐँठा *ainla*, 1263.ऐँठन *ainthan*, 115 (footnote).ऐँठल *ainthal*, 123.ऐँठल रसी *ainthal rassi*, 123.ऐठा *aitha*, 1267.ऐँठा *aintha*, 1267.ऐन *ain*, 1221.ऐसा *aisla*, 1248.

ऐसी *aii*, 1275.
ऐसन *aisan*, 1088.

ऐसी *aisi*, 655.
ऐहब *aihab*, 1277.

॥ ओ ० ॥

ओङ्का *onkra*, 412.
ओखरा *okhra*, 616.
ओखरी *okhri*, 431, 464, 612, 616.
ओखला *okhla*, 431.
ओखली *okhli*, 464, 616.
ओगरा *ogra*, 1272.
ओहाओन *ochhāon*, 637.
ओहौना *ochhawna*, 637.
ओहार *ojhāi*, 1453.
ओठनी *otni*, 1017.
ओटार *otāi*, 1017.
ओठगन *othgan*, 1259.
ओठगनी *othgani*, 1259.
ओड़िया *oriya*, 43, 288.
ओड़ैसा *oraisa*, 44, 93.
ओड़ना *orhna*, 133.
ओड़नी *orhni*, 745.
ओड़ौल *orhaul*, 1457.
ओड़नारन *odwāin*, 639.
ओड़ारन *odāin*, 639.
ओदान *odān*, 639.

ओनचन *onchan*, 639.
ओपनी *opni*, 536.
ओबटन *obtan*, 1342.
ओरचन *orchan*, 244, 639.
ओरदवानो *ordawāni*, 639.
ओरदावन *ordāwan*, 244.
ओरहा *orha*, 877, 957, 984, 990,
1272.
ओरियानी *oriyāni*, 1252.
ओलती *olti*, 1252.
ओलवारो *olwāri*, 562.
ओसरा *osra*, 1242.
ओसरो *osro*, 1242.
ओसाप्रब *osāēb*, 897.
ओसारा *osāra*, 1242.
ओसारी *osāri*, 1242.
ओसौनी *osauni*, 319n, 897.
ओसाप्रब *ohāēb*, 1115.
ओहार *ohār*, 216, 554.
ओहारी *ohāri*, 490, 1252.
ओहा *osta*, 383.

॥ ओ ० ॥

ओ ०, 964, 1088, 1092, 1383.
ओकर *okar*, 1486.
ओकर टाट उलटल है *okar tāt
ultal hai*, 1486.
ओका *oka*, 646.
ओकर *okhar*, 489, 612, 616.
ओका *ojha*, 639, 1453.
ओटब *otab*, 1017.
ओंटब *ontab*, 1017.

ओटा *ota*, 78, 722, 1243.
ओड़ा *ora*, 43, 44.
ओड़ी *ori*, 43, 288, 308.
ओतब *otab*, 1246.
ओध *odh*, 814.
ओर *or*, 964, 1088.
ओरी *ori*, 1183, 1252.
ओरी डीनी *ori tīni*, 1183.
ओसर *osar*, 1118.

॥ औ au ॥

औंजली *aunjli*, 1436.
औंगर *auntāi*, 1017.

औहा *aulha*, 882.

॥ औ au ॥

औ *au*, 1217.
औषा औषा *aua baua*, 1088.
औंकर *aunkar*, 1183.
औंगर *augār*, 26.
औंख *aunchhab*, 1402.
औंठी *aunthi*, 756, 769.

औदार *audār*, 1098.
औंषा *aundha*, 1262.
औरङ्ग *aurang*, 1074.
औरा *aura*, 1294.
औरा औरा *aura baura*, 1294.

॥ क k ॥

कं *kañ*, 1451.
ककड़ी *kakri*, 1070.
ककड़ी *kankri*, 1266.
ककना *kakna*, 768, 1075.
कंकना *kankna*, 768.
कंकनी *kankni*, 768.
कंकरीची *kankrāhi*, 794.
कंकरी *kankri*, 1087.
कक्रेजा *kakreja*, 742.
कंकरोटिया *kankrotiya*, 794.
ककवा *kakua*, 747.
ककवा *kakha*, 747.
ककही *kakhi*, 747.
ककीर *kakīr*, 1049.
ककेर *kaker*, 1049.
कंगड़ा *kangra*, 1033.
कंगना *kangna*, 768, 1378.
कंगना बांधव *kangna bāndhab*, 1378.
कंगनिया *kanganiya*, 792.
कंगनी *kangni*, 571.
कगमुहूँ *kagmuhūn*, 516.
कंगही *kangahi*, 747.
कचरा *kachra*, 768.
ककर *kankar*, 794, 1266.
ककन *kankan*, 1323.

कङ्गन *kangan*, 1323.
कककोह *kachkoh*, 1264.
कचरस *kachras*, 1014, 1272.
कचरा *kachra*, 768, 1004.
कचरी *kachri*, 877, 1004, 1042, 1265.
कचरुकी *kachrukhi*, 558.
कचविया *kachwaniya*, 1272.
कचिया *kachiya*, 73b.
कचुषा *kachua*, 1052.
कचोरा *kachora*, 677.
कचोषा *kachoha*, 1074.
कचौड़ी *kachauri*, 1272.
कचौरी *kachauri*, 1002 (footnote).
कचौष *kachaus*, 786.
कचक *kachchak*, 399.
कचा *kachcha*, 877, 920b, 1235, 1263, 1492, 1495, 1497.
कचा कोष *kachcha kos*, 1492.
कचा पका *kachcha pakka*, 1235.
कचा बिगचा *kachcha bigha*, 1495.
कची *kachchi*, 1499.
कची रत्ती *kachchi ratti*, 1499.
कचू *kachchu*, 1061.
कचा *kachcha*, 1418, 726.
कचाड़ *kachhār*, 792.

- कच्छा *kachhāra*, 792.
 कच्छुया *kachhuiya*, 786.
 कजरी *kajari*, 96.
 कजरघरो *kajargharo*, 970.
 कजरा *kajra*, 1074.
 कजरी *kajri*, 969b, 977, 1074, 1183.
 कजराटा *kajrauta*, 747.
 कजराटी *kajrauti*, 747.
 कजला *kajla*, 1074, 1183.
 कज्जक *kajjak*, 399.
 कञ्चन *kanchan*, 977.
 कञ्चन चुर *kanchan chūr*, 977.
 कञ्चन पुरी *kanchan pūri*, 679.
 कञ्चा *kancha*, 1235.
 कञ्चा पञ्चा *kancha pakka*, 1235.
 कञ्चो *kanchho*, 1014.
 कञ्चो रस *kanchho ros*, 1014.
 कञ्जर *kanjar*, 594.
 कठकिरा *katkira*, 533.
 कठना *katna*, 569.
 कठनिचा *katniya*, 874.
 कठनिहार *katnihār*, 874, 886 (foot-note).
 कठनी *katni*, 574, 873, 874, 1024.
 कठनी *katarni*, 482.
 कठना *katna*, 1175.
 कठसर *katsar*, 765.
 कठसर *kathar*, 1405.
 कठहरा *katahra*, 228.
 कठारी *katāri*, 131.
 कंठिया *kantiya*, 136, 140, 432, 442, 713, 1422.
 कठिया *katia*, 136, 713, 873.
 कठुया *katua*, 894, 990, 994, 995, 997.
 कठु *katui*, 875, 1074, 1163.
 कठु दही *katui dahi*, 1163.
 कठुओ *katuo*, 994, 995.
 कंठेलो *kantelo*, 95.
 कठेसर *katesar*, 765.
 कठैया *kataiya*, 1074.
 कठोरया *katoiya*, 1074.
 कठोर *katoī*, 1074.
 कठोरा *katora*, 449, 677, 678, 711.
 कठोरी *katori*, 383, 535, 553, 778.
 कट्टा *katta*, 1144, 1456.
 कट्टा *kattha*, 1495.
 कठ *kath*, 414.
 कठथपरी *kathathri*, 576.
 कठरी *kathai*, 136, 137.
 कठका *kathka*, 390.
 कठकिरा *kathkira*, 533.
 कठकिल्ली *kathkilli*, 179.
 कठकुचाँ *kathkūān*, 924.
 कठपुरपी *kathkhurpi*, 305, 306.
 कठनही *kathnahi*, 929.
 कठन्धन *kathbandhan*, 1130.
 कठबेटा *kathbeta*, 1279.
 कठ भौंथी *kath bhān̄thi*, 414.
 कठरा *kathra*, 93, 226, 430, 442, 462, 543, 584, 714, 1131.
 कठरंगनी *kathrengni*, 1075.
 कठला *kathla*, 226.
 कठली *kathli*, 136, 714.
 कठवत *kathvat*, 39, 319n, 462.
 कठही *kathahi*, 305.
 कठा *katha*, 1194.
 कठाधर *kathādhār*, 913.
 कठार *kathār*, 1058.
 कठारी *kathāri*, 782.
 कठुली *kathuli*, 39, 714.
 कठोली *katholi*, 714.
 कठौया *kathaua*, 64.
 कठौत *kathaut*, 319n, 584, 714.
 कठौता *kathauta*, 319n.
 कठौती *kathauti*, 319n, 430, 442, 462, 543, 584, 714.
 कठौर *kathaur*, 328.
 कठुवा *karra*, 852.
 कठुवा *kanrra*, 852.

- कँडरा *kanrra*, 848.
 कडरु *karru*, 1120.
 कडुवा *karua*, 233.
 कँडुवा *kanruva*, 233.
 कँडुवावी *kanruvāni*, 815.
 कडरुहरी *karhari*, 169, 179.
 कडुवा *karha*, 140.
 कडुवार *karhāi*, 455, 506, 584.
 कडुही *karhi*, 140.
 कडा *kara*, 226, 455, 673, 757, 759,
 771, 936, 1406.
 कडाह *karāh*, 285, 308, 671.
 कडाही *karāhi*, 138, 455, 465, 506,
 563, 673, 936.
 कडिया *kariya*, 455.
 कँडिया *kauriya*, 431.
 कड़ी *kari*, 35, 169, 223, 233, 936,
 1258.
 कडुवा *karua*, 1023.
 कडुवो *karuo*, 1023.
 कडुनी *karhni*, 319k.
 कडार *karhāi*, 430.
 कडुवा *karhua*, 1272, 1290.
 कडुर *karhūi*, 1290.
 कडौर *karhaur*, 1475.
 कडा *kantu*, 37, 328, 935.
 कडावा *kantāha*, 1425.
 कड *kanth*, 29.
 कडा *kantha*, 226, 749, 755, 1173.
 कडार *kanthār*, 1173.
 कडा रोग *kantha rog*, 1173.
 कडा सारु *kantha sāru*, 1173.
 कडी *kanthi*, 29, 1429.
 कडा *kanda*, 848, 852.
 कनई गज *katai gaj*, 1491.
 कतय *katay*, 1087.
 कतरनी *katarni*, 588.
 कतरपारा *katarpāra*, 292.
 कतरगवा *katarbaha*, 294.
 कतरगवाह *katarwāh*, 294.
 कतरगवाहा *katarwāha*, 294.
 कतरा *katra*, 362a, 403, 497, 1183.
 कतरा के जड़ *katra ke jar*, 362a.
 कतरिवाह *katariwāh*, 294.
 कतरि *katari*, 403.
 कतरनी *katri*, 255, 258, 272, 278,
 558, 768, 1074.
 कंतरी *kantri*, 138.
 कतरुही *katrohi*, 403.
 कतगडा *katla*, 497.
 कतवा *katwa*, 768.
 कतिका *katika*, 967b, 996.
 कतिकी *katiki*, 1039.
 कतेक *katek*, 1085.
 कता *katta*, 74.
 कती *katti*, 713, 1491.
 कती गज *katti gaj*, 1491.
 कथ *kath*, 1073.
 कथा *katha*, 1286.
 कथा करव *katha karab*, 1286.
 कदई *kadāi*, 788, 789.
 कदम *kadam*, 585, 1492, 1495.
 कदमक *kadamak*, 726 (note).
 कदम ग्राह *kadam gāchh*, 585.
 कँडरी *kandri*, 920.
 कदवा *kadva*, 824, 981, 1399.
 कदीमा *kadīma*, 1071.
 कदीमी *kadīmi*, 1215.
 कदुवा *kadua*, 1068.
 कँडूरी *kandūri*, 1369, 1377.
 कदेठ *kadaith*, 579.
 कडोर *kadoi*, 787, 788, 789.
 कडु *kaddu*, 1068.
 कंधावर *kandhāvar*, 1348.
 कंधेला *kandhela*, 363.
 कन *kan*, 913, 1052, 1062.
 कनई *kanai*, 1024.
 कनक *kanak*, 972, 978.
 कनक चूर *kanak chūr*, 978.
 कनक जीर *kanak jīr*, 972.

कनकजीरा *kanakjira*, 974.
 कनकठिया *kankathiya*, 1416.
 कनकपुरिया *kanakpuriya*, 1057.
 कनकिल्ली *kankilli*, 15.
 कनकुत्ती बटार *kankutti batāi*, 913.
 कनकुत्त *kankūt*, 913.
 कनखी *kankhi*, 1011.
 कनगोजर *kangojar*, 1010.
 कनगप्पा *kanjhappa*, 725.
 कनगप्पी *kanjhappi*, 725.
 कनगप्पो *kanjhappo*, 725.
 कनगहोपा *kanjhopa*, 725.
 कनगटोप *kantop*, 725.
 कनगोर *kantor*, 656.
 कनगुल *kanphul*, 764.
 कनब *kanab*, 913.
 कनबदा *kanbada*, 967c.
 कनबाला *kanbāla*, 753.
 कनवई *kanwāi*, 1497.
 कनवह *kanwah*, 954.
 कनवा *kanwa*, 954, 1173, 1183.
 कनवाई *kanwān*, 1054, 1075, 1491,
 1497, 1498.
 कनसन *kansan*, 1075.
 कनसार *kansār*, 434.
 कनसारी *kansāri*, 434.
 कनसी *kansi*, 1001, 1010.
 कनारल *kanāil*, 1011.
 कनाठ *kanāth*, 864.
 कनाठा *kanātha*, 1074.
 कनासी *kanāsi*, 403.
 कनार *kanār*, 102.
 कनाह *kanāh*, 1011.
 कनाहा *kanāha*, 1011.
 कनिशैली *kanisāli*, 1348.
 कनिक *kanik*, 1272.
 कनिवाप्रल *kaniyāēl*, 957, 1018.
 कनिवाप्रल वाचन है *kaniyāēl āwa hai*,
 957.
 कनिल *kanil*, 797.

कनिवार *kanisār*, 434.
 कनेई *kaneān*, 741, 1282, 1328.
 कनेवार *kaneāi*, 1322, 1327.
 कनेवाई दान *kaneān dān*, 1328, 1329,
 1330, 1346.
 कनेटा *kaneta*, 1251.
 कनेटी *kaneti*, 929.
 कनेल *kanail*, 15, 194, 275, 938, 1024.
 कनेली *kanaili*, 275, 363, 764.
 कनोजर *kanojar*, 1010, 1024.
 कनौसी *kanausi*, 20, 753, 764.
 कन *kant*, 568, 1113.
 कना *kanta*, 1087.
 कन्दाई *kandāi*, 1023.
 कन्दा *kanda*, 1061.
 कन्दी *kandī*, 373.
 कन्धा *kundha*, 274.
 कन्ना *kanna*, 404, 455, 933, 940,
 1075, 1183.
 कन्नी *kanni*, 933, 957.
 कन्धारन *kanyān*, 1282.
 कन्सी *kansi*, 451.
 कन्हावर *kanhāwar*, 1348.
 कन्धिया *kankhiya*, 274.
 कन्धी *kanhi*, 1074.
 कन्हेली *kanheli*, 125, 126, 275.
 कपन्हेरी *kapchheri*, 485.
 कपन्डा *kapta*, 1074.
 कपन्डी *kapti*, 713.
 कपन्दा *kopra*, 398, 723, 1402.
 कपन्दा लत्ता *kapra latta*, 723.
 कपरन्धूर *kapardhūr*, 607.
 कपरन्नी *kapurni*, 363.
 कपरन्बिनी *kaparbinni*, 363.
 कपरन्बीनी *kaparbīni*, 363.
 कपरन्रौट *kapraut*, 530.
 कपरन्रौट *kumpraout*, 530.
 कपार *kapāi*, 134, 647, 1145.
 कपार *kapār*, 833.
 कपारी फोरल *kapāri phoral*, 1018.

- कपास *kapās*, 1016, 1017, 1018, 1019, 1089.
 कपास फूटव *kapās phūtab*, 1018.
 कपूरी *kapūri*, 1049.
 कप्पा *kappa*, 726.
 कप्पा *kappha*, 1032.
 कफगिर *kaphgir*, 450.
 कफञ्चा *kaphcha*, 450.
 कफन्नाग्रव *kaphnāeb*, 1418.
 कफन्नी *kaphni*, 1418, 1431.
 कफा *kapha*, 1032, 1033.
 कव *kab*, 1275.
 कवज *kabaj*, 1467.
 कवजाना *kabjana*, 1198.
 कवर *kabr*, 1431.
 कवर खोद्दार *kabr khodāi*, 1431.
 कवरिया *kabariya*, 864.
 कवरिखान *kabristān*, 1431.
 कवरिवा *kabariha*, 864.
 कवन्ना *kabla*, 416, 417.
 कवन्नी *kabli*, 1000.
 कवा *kaba*, 729.
 कवाच *kabāb*, 447.
 कवाच दानी *kabāb dāni*, 447.
 कवि *kabi*, 655.
 कविरञ्चा *kabirha*, 1429.
 कबिला *kabila*, 1275, 1276.
 कबिली *kabili*, 1000.
 कबूली *kabūli*, 963, 1272.
 कस *kam*, 240.
 कसञ्ची *kamchi*, 592.
 कसन्ठा *kamtha*, 601.
 कसन्ठी *kamthi*, 576.
 कसन्दरन्ना *kamdharina*, 557.
 कस धारा *kam dhāra*, 532.
 कसखल *kamandal*, 782.
 कसजन्गर *kamangar*, 601.
 कसर *kamar*, 655, 1020.
 कसरकस *kamarkas*, 770.
 कसरखोद्दार *kamarkholāi*, 1205.
 कसरञ्जीव *kamarjeb*, 770.
 कसरन्तोद *kamartōi*, 743.
 कसररुवा *kamrathua*, 1460.
 कसरपन्थू *kamarpanthu*, 1460.
 कसरन्बला *kamarballa*, 1257.
 कसरन्सायर *kamarsāyar*, 407, 394.
 कसरन्सारी *kamarsāri*, 407.
 कसरा *kamra*, 737.
 कसरिया *kamariya*, 737, 1184.
 कसरी *kamri*, 344, 737.
 कसल पतर *kamalpatr*, 1073.
 कसन्ना परन्साद *kamla parsād*, 975.
 कसन्सरे *kamsare*, 1217.
 कसन्सैर *kamhār*, 363.
 कसन्सवा *kamhanda*, 363.
 कसन्सर *kamhar*, 363, 489.
 कसाद *kamāi*, 842, 1194, 1196, 1197, 1412.
 कसान *kamān*, 601.
 कसानक *kamānak*, 398.
 कसाना *kamāna*, 538, 1141.
 कसानो *kamāni*, 398, 415, 416, 470, 538.
 कमार *kamār*, 394, 407.
 कमारी *kamāri*, 143.
 कमिचर *kamiar*, 1186.
 कमिचरी *kamiyar*, 842.
 कमियाँ *kamiyān*, 842, 844, 1184.
 कमियोटी *kamiyauti*, 1186.
 कमी *kami*, 1217.
 कमीना *kamina*, 1141, 1217.
 कमुवा *kamua*, 1074.
 कमेवाच *kamaitāh*, 394.
 कमेनी *kamaini*, 866, 867, 1194.
 कमोच *kamoch*, 972.
 कमोदी *kamodi*, 978.
 कमोरा *kamora*, 277.
 कसौनी *kamauni*, 866, 867.
 कम्पनी *kampani*, 1202; Appendix, 14.
 कम्पा *kampa*, 381.

- कम्पास *kampās*, 419, 519.
 कम्मार *kammār*, 737.
 कम्मल *kammāl*, 737.
 कम्पा *kamma*, 1074.
 कम्पेया *kamhaiya*, 915.
 कर *kar*, 363, 1025.
 करई *karāi*, 713.
 करकट *karkat*, 1117.
 करकन्द्या *karkandha*, 1138.
 करका *karka*, 786.
 करकुट *karkut*, 329.
 करके *karke*, 1087.
 करखा *karḥa*, 69.
 करखाना *karkhāna*, 312.
 करखाहि *karkhāhi*, 69.
 करखाहि हँडिया *karkhāhi hanriya*,
 69.
 करखी *karḥi*, 69.
 करखो *karḥo*, 69.
 करगह *kargah*, 363.
 करंगा *karnga*, 966a.
 करंगी *karngi*, 966b.
 करची *karḥi*, 353, 1119, 1308.
 करकुल *karḥhul*, 319k, 564, 684.
 करज *karj*, 1461, 1476.
 करज खोर *karj khor*, 1461.
 करज खौक *karj khauk*, 1461.
 करजनी *karjani*, 1499.
 करजन्वाम *karjwām*, 1476.
 करजा *karja*, 1187, 1188, 1190,
 1476.
 करजेन *karjain*, 1191.
 करतली *kartali*, 225.
 कर्ता *karta*, 730, 1394, 1418, 1419,
 1420, 1422, 1423, 1426.
 कर्ता पुत्र *karta putr*, 1394.
 कर्ती मुरी *karti mūri*, 1119.
 करथरी *karthari*, 576.
 करथि *karathi*, 1272.
 करधन *kardhan*, 758.
 करधनी *kardhani*, 758, 770.
 करनफूल *karanphūl*, 764.
 कर्ना *karna*, 138, 713.
 कर्नी *karni*, 422.
 करन्त *karant*, 1091.
 करब *karab* 358, 362a, 855, 981,
 1143, 1246, 1286, 1339, 1343,
 1402, 1408, 1416, 1419, 1451,
 1452; 1484.
 कर्बा *karba*, 356.
 करबार *karbār*, 363.
 कर्म *karm*, 1428, 1446.
 करमकला *karamkalla*, 1073.
 कर्मा *karma*, 972.
 कर्मा धर्मा *karma dharma*, 1446.
 कर्माला *karmāla*, 781.
 कर्मिया *karmiya*, 1059.
 कर्मी *kurmi*, 1183.
 कर्मी लत *karmi lat*, 1183.
 कररुवा *kararua*, 1049.
 करल *karal*, 873.
 कर्वा *karwa*, 432, 713.
 करसी *karṣi*, 848, 852.
 करह *karah*, 1090, 1451.
 करहन्नी *karhanni*, 966c, 966d, 967d,
 969c.
 करहा *karha*, 832, 836, 954.
 करहार *karhāi*, 554.
 करहिया *karahiya*, 713.
 करा *kara*, 673.
 करार *karāi*, 996, 1084.
 करापब *karāeb*, 1408, 1418, 1430.
 करान्त *karānt*, 1496.
 करबा *karāba*, 372.
 कराम *karām*, 889.
 करार *karār*, 786, 1183.
 करारा *karāra*, 792.
 करा लापब *kara lāeb*, 25.
 कराह *karāh*, 285, 308, 312, 319.
 कराह के घर *karāh ke ghar*, 312.

कराघ घर *karāh ghar*, 324.
 कराघा *karāha*, 285, 319.
 कराही *karāhi*, 308, 319, 673, 711,
 713.
 करिकन्धा *karikandha*, 1138.
 करिषा *karikha*, 69.
 करिखार *karikhāi*, 69.
 करिखार हँरी *karikhāi hāri*, 69.
 करिंगन्वाघ *karingwāh*, 950.
 करिगघ *karigah*, 356, 363.
 करि देव *kari deb*, 1339.
 करिगन्वाघ *karinwāh*, 950.
 करिबया *kariyawa*, 1113, 1137.
 करिषा *kariya*, 996, 1137.
 करिषठ *kariha*, 1113.
 करौंग *karing*, 950.
 करौन *karin*, 950.
 करषा *karua*, 1045, 1137.
 करषा तेल *karua tel*, 1045.
 करषार *karuār*, 13, 237.
 करषारा *karuāra*, 13.
 करषारी *karuāri*, 13, 237.
 करर *karui*, 44.
 कररु *karuchh*, 458.
 करुणा *karuna*, 139.
 करु *karu*, 1045.
 करु तेल *karu tel*, 1045.
 करे *kare*, 1084, 1088.
 करेम *karem*, 1183.
 करै *karai*, 1088.
 करैल *karail*, 786, 808, 1067.
 करैला *karaila*, 1067.
 करैली *karaili*, 569, 1067.
 करैली कठग्ना *karaili katna*, 569.
 कल *kal*, 265, 330, 1023.
 कलकतिया *kalkatiya*, 1021.
 कलहहा *kalchha*, 684.
 कलहही *kalchhi*, 684, 774.
 कलहहुल *kalchhul*, 438, 458, 684.
 कलहहुला *kalchhula*, 438, 564.

कल जुग *kal jug*, 1023.
 कल जुग के अम्रित *kal jug ke amrit*,
 1023.
 कलडगरी *kalatri*, 1207.
 कलमन्दरा *kalandara*, 1256.
 कलप *kalap*, 389.
 कलप *kalaph*, 389.
 कलबुद *kalbud*, 565, 582.
 कलबुत *kalbūt*, 484.
 कलबुद *kalbūd*, 484.
 कलम *kalam*, 422, 521, 541, 1033,
 1039, 1052.
 कलमनी *kalmi*, 370, 422, 1039, 1073.
 कलमनी घाम *kalmi sāg*, 1073.
 कलमनी सोरा *kalmi sora*, 370.
 कलमरा *kalra*, 1395.
 कलम्वार *kalwār*, 371.
 कलम्व *kalsa*, 713, 1307, 1308,
 1329, 1374.
 कलम्वी *kalsi*, 693, 713.
 कला *kala*, 585f.
 कलार *kalāi*, 996.
 कलाएल *kalāēl*, 957.
 कलाबुत *kalābūt*, 582.
 कलाल *kalāl*, 371.
 कलाली *kalāli*, 371.
 कलावा *kalāwa*, 1381.
 कलिदार *kalidār*, 727.
 कलिघान *kahiyān*, 1138.
 कली *kali*, 765, 977, 1037, 1267.
 कलुषा *kalua*, 1456.
 कलुषा बीर *kalua bir*, 1456.
 कलुह *kahuchh*, 438.
 कलुष *kalus*, 438.
 कलुज *kaleu*, 1269.
 कलुवा *kalewa*, 1269.
 कलौगर *kalaigar*, 510.
 कलोर *kalor*, 1118.
 कलौ *kalau*, 1269, 1341.
 कलौचा *kalaua*, 1269.

कवण्डल *kañwandal*, 715.
 कवर *kawar*, 1271.
 कवाह *kawāchh*, 1073.
 कँवारन्धु *kamwārīhu*, 1460.
 कसन्कुट *kaskut*, 666, 689.
 कसन्कौल *kaskaul*, 715.
 कसन्तरा *kastara*, 713.
 कसन्तरी *kastari*, 678, 713.
 कसन *kasam*, 507, 249.
 कसनि *kasani*, 744.
 कसन्मिरा *kasmira*, 1047.
 कसर *kasar*, 900.
 कसन्धा *kasla*, 525.
 कँसन्धा *kansla*, 525.
 कसन्वा *kaswa*, 1458.
 कसाह *kasāi*, 1141.
 कसार *kasār*, 713, 1272, 1342.
 कसारा *kasāra*, 1342.
 कसावट *kasawat*, 249.
 कँसाधुरी *kansāsuri*, 1101.
 कँसुला *kansula*, 525.
 कसेरा *kasera*, 469, 556, 548.
 कसेया *kasaiya*, 1142.
 कसेली *kasali*, 1056.
 कसेँजी *kasauñji*, 372.
 कसौठी *kasauti*, 537, 1113, 1134.
 कँसौठी *kansauthi*, 768.
 कह *kah*, 655, 1087.
 कहन्तरी *kahtari*, 139.
 कहन्तारी *kahtāri*, 1084.
 कहलन्गौँव *kahalgāw*, 1486.
 कहन्वाँ *kahwāñ*, 1275.
 कहहिँ *kahahñ*, 1085.
 कहां *kahān*, 478.
 कहांवे *kahāwai*, 763.
 कहि *kahi*, 1084.
 कहुँ *kahui*, 1256.
 कहे *kahe*, 1088.
 कहेँ *kaheñ*, 1091, 1092.
 कहे *kahi*, 1084.

का *ka*, 414, 1088, 1092, 1367.
 काउन *kāun*, 988.
 काँ *kāin*, 146.
 काण्ड *kaeth*, 1217.
 काक *kāk*, 1398.
 काक बन्धा *kāk banjha*, 1398.
 काँकर *kānkar*, 335e.
 काँकरि *kānkari*, 1070.
 काकुट *kakut*, 86.
 काँकुट *kānkut*, 86.
 काँखी *kānkhi*, 1024.
 काग *kāg*, 1398.
 कागज *kāgaj*, 404.
 कागन्जी *kāggi*, 586.
 काग दुवस *kāg durus*, 1398.
 काग *kāga*, 1088.
 कागी *kāgi*, 1043.
 काँव *kānch*, 1017, 1263.
 काँच रूणा *kānch rūa*, 1017.
 काँचा *kāncha*, 1235.
 काँची *kānchi*, 313, 1272.
 काँची चीनी *kānchi chīni*, 313.
 काह *kāchh*, 233, 790, 1113, 1134.
 काहक पाटी *kāchhak pāti*, 233.
 काहव *kāchhab*, 1030.
 काहा *kāchha*, 726, 743.
 काज *kāj*, 748.
 काजर *kājar*, 747, 1404.
 काट *kāt*, 1452.
 काटव *kātab*, 873, 1024.
 काटवोँ *kātbōn*, 356.
 काँटा *kāntā*, 104, 640, 748, 935.
 काँटा फोड़ी बखिया *kānta phori bakhīya*, 748.
 काँटी *kānti*, 179.
 काटे *kātai*, 356.
 काठी *kāthi*, 1131, 1420.
 काँड़ *kānr*, 889, 890, 986.
 काड़ा *kāra*, 1120.
 काँड़ा *kānra*, 815, 889, 890, 936.

काँड़ी *kāṅṛī*, 137, 612, 1168.

काड़ी *kāṛī*, 1120.

काह *kārh*, 8, 279.

काहब *kārhāb*, 1422, 1478.

काहा *kārha*, 261, 279.

काहि *kārhi*, 1478.

कात *kāt*, 550.

कातर *kātar*, 272, 278.

कातरि *kātari*, 272, 278.

कातिक *kātik*, 1039, 1082, 1083,
1087.

काँडू *kāṅḍū*, 433.

काँडून *kāṅḍūn*, 433.

कादो *kādo*, 423, 1084.

कादो *kādo*, 789, 824, 981, 1086.

कादो करब *kādo karab*, 981.

काँधी *kāndhi*, 261.

कान *kān*, 274, 933, 1420.

कान काठी उतारब *kān kāthi utārab*,
1420.

कानन्दार *kāṅḍār*, 725.

कानन्दार टोपी *kāṅḍār topi*, 725.

काननोसगे *kananotsarg*, 1459.

कानर *kānar*, 952.

कागा *kāna*, 29, 933, 1011, 1075,
1183.

कानी *kāni*, 41, 933, 940.

काँनी *kānni*, 1006.

कानू *kānu*, 293, 303, 433.

कानो *kāno*, 789, 1011.

कानो किचड़ *kāno kichoḥar*, 789.

कान्ह *kānh*, 256, 274.

कान्ही *kānhi*, 1006.

कान्ही के हर *kānhi ke har*, 1006.

कान्हे *kānhe*, 478.

काँप *kāmp*, 764.

काफा *kāpha*, 1032.

काबा *kāba*, 729.

काबिब *kābis*, 786.

काम *kām*, 999 (footnote).

कामधेनुवा *kāmdhenua*, 1164.

कामिनी *kāmini*, 1091.

कामी *kāmi*, 531, 560.

काथ *kayath*, 999 (footnote).

कारचोब *kārchob*, 502.

कारचोबी *kārchobi*, 502.

कारचोबी बाला *kārchobi wāla*, 502.

कारज *kāraj*, 1426.

कारपरदास *kārpardāṣ*, 1208.

कारबार *kārbār*, 1461.

कारा बोगघा *kāra bogha*, 968.

कारिख *kārikh*, 69, 747.

कारी *kāri*, 786, 977, 996, 1137.

कारी बाँक *kāri bānk*, 977.

कारी माटी *kāri māti*, 786.

काह दास *kāru dās*, 1456.

काह बीर *kāru bir*, 1456.

कारे *kāre*, 1089.

कारोबार *kārobār*, 1461.

कारोबारी *kārobāri*, 1461.

कालन्बूत *kālbūt*, 565.

कालन्बूद *kālbūd*, 484.

काला *kāla*, 965a, 996, 1023, 1043.

काला गौर *kāla gūr*, 965a.

कालिब *kālib*, 475.

काली *kāli*, 1455.

काली अस्थान *kāli asthān*, 1455.

कालीन *kālin*, 750.

काशत *kāshṭ*, 911.

कास *kās*, 1075, 1091, 1151.

काँस *kāns*, 1138.

कास चरार *kās charāi*, 1151.

कासनी *kānsi*, 1073.

काँसला *kānsla*, 525.

कासा *kāsa*, 1342.

काँसा *kānsa*, 558, 682, 1342.

काँसी *kānsi*, 1075, 1091.

काँसीवाल *kāsiwāl*, 725.

काँसुला *kānsula*, 525.

कास *kāst*, 1218.

- कासन्कार *kāstkār*, 1215.
 काह *kāh*, 1151; Appendix, 14.
 काच चरार *kāh charāi*, 1151;
 Appendix, 14.
 काहि *kāhi*, 1043.
 काहि सबुजा *kāhi sabuja*, 1043.
 काही *kāhi*, 366, 1235.
 काही पोच *kāhi pos*, 1235.
 काहू *kāhu*, 1073.
 कि *ki*, 1088.
 किंकिनी *kinkini*, 771.
 किचरू *kichchar*, 789.
 किहु *kichhu*, 393, 1085, 1217.
 किता *kita*, 832, 1254, 1370.
 किता पारन्चा *kita pārcha*, 1370.
 किता *kitta*, 832.
 किनिह *kiniha*, 1113.
 किमान *kimām*, 1033.
 कियारा *kiyāra*, 832.
 कियारी *kiyāri*, 832.
 कियारी *kiyāri*, 62.
 कियाली *kiyāli*, 1201.
 कियौरी *kiyauri*, 662.
 किराँची *kirānchi*, 148.
 किराया *kirāya*, 1201.
 किरिन चक्कर *kirin chakkar*, 585.
 किरिया *kiriya*, 1428, 1451.
 किरिया करन्म *kiriya karm*, 1428.
 किरौना *kirauna*, 1074.
 किर्तिक *kirttik*, 1084.
 किलखाना *kilkhāna*, 1140.
 किला *kila*, 585.
 किला *killa*, 431, 443, 464, 573, 621,
 932.
 किल्ली *killi*, 179, 331, 929, 936,
 1250.
 किशन चरणन *kishan arpan*, 1209a.
 किशुन चरणन *kishun arpan*,
 1209a.
 किशन्वत *kisbat*, 383, 388, 734.
 किशन्वद *kisbad*, 383.
 किशन्मत *kismat*, 383, 734.
 किशन्ली के रोटी *kisli ke roti*,
 272.
 किशान *kisān*, 834, 967, 1085, 1086,
 1088, 1091.
 किशुन पख (or पच्छ) *kisun pakh (or*
pachchh), 1081.
 किश *kist*, 1214, 1479.
 किश बन्दी *kist bandi*, 1479.
 किस्ता *kista*, 715.
 की *ki*, 664 (note), 1088, 1183.
 कीच *kīnch*, 789.
 कीचिन *kichin*, 1458.
 कीनह *kinah*, 1087.
 कीया *kiya*, 662.
 कीये *kīye*, 1091.
 कीरी *kiri*, 1074.
 कीरो *kiro*, 1074.
 कील *kil*, 164, 443, 621.
 कीला *kila*, 573.
 कुषार *kuār*, 1082.
 कुषायँ *kuiyān*, 920b, 1459.
 कुषायँ दान *kuiyāñ dān*, 1459.
 कुकरी *kukri*, 353.
 कुकरीवा *kukraundha*, 1183.
 कुकाठ *kukāth*, 286.
 कुकुही *kukurhi*, 353, 1074.
 कुकुसा *kukusa*, 1183.
 कुकुही *kukuhi*, 1074.
 कुचबन्धना *kunchbandhwa*, 599.
 कुचा *kuchcha*, 55.
 कुची *kuchchi*, 536.
 कुजन्दा *kunjra*, 1456.
 कुजात *kujāt*, 1452.
 कुजात करव *kujāt karab*,
 1452.
 कुजाता *kujātra*, 1454.
 कुची *kunchi*, 55.
 कुजी *kunji*, 1250.
 कुटका *kutka*, 325, 417, 896.
 कुटरी *kutri*, 1144.

- कुटाप्रब *kutāeb*, 624.
 कुटाँव *kutānw*, 892.
 कुटिया *kutiya*, 1144.
 कुट्टी *kutti*, 1144, 1234.
 कुठाँव *kuthāñw*, 747.
 कुर्दिया *kudanriya*, 277.
 कुदन्दी *kudandi*, 33.
 कुदन्दिना *kurdahina*, 831, 889.
 कुदन्मुन्दन *kunrmundan*, 1434.
 कुदन्मुन्नन *kunrmūnan*, 1434.
 कुदिबा चास *kunriya chās*, 801.
 कुदिवाटी *kunriyāthi*, 929.
 कुदिबा *kurhiya*, 713.
 कुड *kund*, 268.
 कुडल *kundal*, 753.
 कुडली *kundli*, 1343.
 कुडा *kunda*, 143, 284, 368, 437,
 505, 713, 1349.
 कुडी *kundi*, 929.
 कुतुरम *kuturum*, 1047.
 कुत्ता *kutta*, 711, 1084, 1087.
 कुत्ती *kutti*, 711.
 कुत्तो *kutto*, 655.
 कुदरुम *kudrum*, 1047.
 कुदर *kudār*, 27, 28, 328.
 कुदरि *kudāri*, 328.
 कुदारी *kudāri*, 28, 369, 1048.
 कुदाल *kudāl*, 28.
 कुदाली *kudāli*, 28.
 कुडी *kuddi*, 82, 1203.
 कुनरी *kunri*, 1073.
 कुन्ती *kunti*, 1272.
 कुन्द *kund*, 469, 570, 557.
 कुन्दा *kunda*, 401, 1141.
 कुन्दी *kundi*, 391, 1141.
 कुपोत्सरग *kupotsarg*, 1459.
 कुप्पा *kuppa*, 719, 720.
 कुप्पी *kuppi*, 719, 1160.
 कुप्पी के ग्यु *kuppi ke ghyu*, 1160.
 कुब्बी *kubbi*, 856, 859.
 कुमरुठी *kumarhauti*, 786.
 कुमरुठी *kumrauti*, 786.
 कुम्भी *kumbhi*, 1125.
 कुम्हार *kumhar*, 1071.
 कुम्हरा *kumhra*, 572.
 कुम्हार *kumhār*, 572, 1209b.
 कुम्हस *kumhes*, 1080.
 कुम्हस *kumhaiin*, 572.
 कुम्हसि *kumhaiini*, 572.
 कुम्ता *kurta*, 744.
 कुम्ताली *kurtāli*, 902.
 कुम्ठी *kurthi*, 999.
 कुम्ठीली *kurthauli*, 1219.
 कुम्हन *kurdan*, 616.
 कुम्हिन *kurmin*, 1090.
 कुराव *kurāo*, 797.
 कुरम *kurun*, 602.
 कुरर *kurūr*, 439.
 कुरैल *kurail*, 646.
 कुल *kul*, 1432, 1456.
 कुलनारा *kultāra*, 412.
 कुल देवीना *kul deota*, 1456.
 कुलम्भी *kulphi*, 398, 473, 585.
 कुलम्भीदार *kulphidār*, 473a.
 कुल्हार *kulhar*, 798, 818.
 कुल्हारी *kulhāri*, 395.
 कुल्हिबा *kulhiya*, 585, 725.
 कुल्ही *kulhi*, 725.
 कुस *kus*, 1428.
 कुसगुम *kusagum*, 1454.
 कुसगुमर *kusputr*, 1428.
 कुसवत्तना *kusvatna*, 1074.
 कुसही *kusahi*, 959, 1000.
 कुसही केराव *kusahi kerāo*, 959.
 कुसासन *kusāit*, 1454.
 कुसियाना *kusiyāna*, 1074.
 कुसियार *kusiyār*, 1005.
 कुसियार *kusihār*, 1005.
 कुसी *kusi*, 1088.
 कुसुम *kusum*, 1043.
 कुहसा *kuhassa*, 1080.
 कुहहार *kulhār*, 572.

- कुहेस *kuhes*, 1080.
 कुहेसा *kuhesa*, 1080.
 कुआँ *kūān*, 916, 920*b*, and 920*c*,
 1092.
 कुँच *kūnch*, 362*a*, 599.
 कुँचा *kūncha*, 53, 55, 465.
 कुँची *kūnchi*, 54, 428, 465, 543,
 599.
 कुटब *kūtab*, 624.
 कुटल जाख *kūtal jāib*, 624.
 कुटि देब *kūti deb*, 624.
 कुटी *kūti*, 1234.
 कुँइ *kūnr*, 268, 505, 713, 929.
 कुड़ा *kūra*, 848.
 कुँड़ा *kūnra*, 83, 143, 437, 713,
 1434.
 कुड़ा कुरकुट *kūra kurkut*, 848.
 कुँड़ी *kūnri*, 83, 308, 929.
 कुँइ *kūnrh*, 251.
 कुड़ा *kūrha*, 879, 1234.
 कुत *kūt*, 913.
 कुदे *kūde*, 128 (footnote).
 कुन *kūn*, 538.
 कुप *kūp*, 920*b*, 1091.
 कुप जग *kūp jag*, 1459.
 कुबड़ *kūbar*, 1260.
 कुर *kūr*, 849.
 कुरो *kūro*, 1495.
 कुसी *kūsi*, 1091.
 कुहा *kūha*, 1080.
 के *ke*, 312, 445, 463, 478, 585*f*, 724,
 748, 814, 990, 1006, 1008,
 1009, 1015, 1023, 1025, 1040,
 1045, 1057, 1073, 825, 829, 849,
 919, 1118, 1139, 1175, 1183,
 1207, 1208, 1235, 1272, 1275,
 1377, 1479.
 केचारी *keāri*, 62.
 केचाल *keāl*, 914.
 केचाली *keāli*, 914, 1201.
 केँडवाँ *keñuān*, 1074.
 केँचोचा *keñocha*, 456.
 केइवारी *keruāri*, 814.
 केतरपारा *ketarpāra*, 292.
 केतार *ketār*, 1005.
 केतारा *ketāra*, 1005.
 केतारी *ketāri*, 292, 1005, 1006.
 केनाम *kemām*, 1033.
 केरवा *kerwa*, 959.
 केराइ *kerāi*, 959, 960, 1000, 1089.
 केराव *kerāo*, 959, 960, 1000.
 केरवार *keruār*, 237.
 केरौनी *kerāuni*, 866, 867.
 केलाुनी *kelauni*, 866, 867.
 केवलचा *kevalha*, 956.
 केवाँइ *kewānchh*, 1073.
 केवाइ *kewār*, 1249.
 केवाँइ *keñwāñr*, 1249.
 केवाड़ी *keñwāri*, 1249.
 केवाँड़ी *keñwāñri*, 1249.
 केवाल *kewāl*, 786.
 केवाली *kewāli*, 1005.
 केवाही *kewāhi*, 1005.
 केसरिया *kesariya*, 1043.
 केसौर *kesaur*, 1062.
 केहनी *kehuni*, 882, 886.
 केहनीदार कुसुपी *kehumidār kulphi*,
 473.
 के *ke*, 414, 568, 964, 1002 (foot-
 note), 1073, 1085, 1087, 1089.
 केँ *ken*, 356, 393, 604, 657, 741,
 841, 886 (footnote), 964, 1090.
 केड़ा *kerā*, 1204.
 केँड़ा *kenra*, 425.
 केना *kena*, 1075, 1183, 1436.
 केना देहरी *kena dehri*, 1436.
 केवल *kebal*, 973.
 केर *ker*, 393.
 केखू *kelhu*, 250.
 केसर *kesar*, 975.

- केजी *kesi*, 984.
 कैचिया *kainchiya*, 73, 226.
 कैरियार *kairiyār*, 807.
 कैलाप्रथ *kailāḍ*, 957.
 कैलिया *kailiya*, 1074.
 कै *kai*, 1087, 1113.
 कैच *kainch*, 322, 1256.
 कैची *kainchi*, 226, 383, 474, 499,
 512, 522, 539, 550, 588, 1256.
 कैटी *kaiti*, 1034.
 कैटी *kainti*, 1034.
 कैरा *kainra*, 425.
 कैत *kait*, 585f, 1073.
 कैता *kaita*, 1072, 1073.
 कैन्दान *kaitbān*, 585f.
 कैतुक *kaituk*, 1456.
 कैतुक गोचरि *kaituk gosārī*, 1456.
 कैदक *kaidak*, 1466.
 कैया *kaiya*, 511, 551
 कैल *kail*, 1134.
 कैला *kaila*, 1113, 1134.
 कैला गेल *kaila gel*, 957.
 कैली *kailn*, 1002 (footnote).
 कैसे *kaise*, 1026.
 कोरनी *koini*, 1045.
 कोरन्दा *kōinda*, 1045.
 कोरवा *koiya*, 1074.
 कोररी *koiri*, 807.
 कोरला *koila*, 1440, 1456.
 कोरला माता *koila māta*, 1440, 1456.
 कोरली *koilī*, 1074.
 कोप्रला *koela*, 347.
 कोकटी *kokti*, 329, 1016, 1019.
 कोकिला *kokila*, 468.
 कोचबन *kochban*, 770.
 कोचन्दा *kochla*, 1073.
 कोचन्दा के साग *kochla ke sāg*, 1073.
 कोचानी *kochāni*, 1245.
 कोठार *kothwār*, 1400.
 कोठिए *kothie*, 1090.
 कोठिया *kothiya*, 1263.
 कोठिया रेंडा *kothiya rēṅṅa*, 1263.
 कोठियारी *kothiyāri*, 1201.
 कोठियौ *kothiyau*, 890.
 कोठिला *kothila*, 924, 77.
 कोठिली *kothilī*, 77, 85.
 कोरुनी *korni*, 824, 865, 866, 867,
 1009.
 कोरार *korār*, 808.
 कोरिया *korhiya*, 1074.
 कोरिला *korhila*, 1183.
 कोतवात *kotwāl*, 1200.
 कोथली *kothlī*, 770.
 कोदर *kodār*, 992.
 कोदार *kodār*, 27, 28, 369.
 कोदारि *kodāri*, 28.
 कोदारी *kodāri*, 28, 319k.
 कोनसिया *konasiya*, 828.
 कोनसी *konasi*, 828.
 कोनासी *konāsi*, 832.
 कोनिया *koniya*, 603, 828.
 कोनिवा जोत *koniya jot*, 828.
 कोन्हा *komhra*, 1071.
 कोरर *korār*, 367, 1050.
 कोरन्दा *korānja*, 844.
 कोरपोछुषा *korponchhua*, 1397.
 कोरन्मार *kormār*, 161.
 कोरन्वास *korwās*, 1051.
 कोरन्सत *korsūt*, 404.
 कोरार *korāi*, 894.
 कोरान्त *korānt*, 807.
 कोराना *korāna*, 1185.
 कोरार *korār*, 784, 807.
 कोरियार *koriyār*, 807.
 कोरेना *korena*, 372.
 कोरौनी *korāuni*, 1161.
 कोलन्डारा *koltāra*, 412.
 कोलन्वार *kolwāi*, 832.
 कोलन्सार *kolsār*, 297, 300.
 कोलन्सुप *kolsup*, 47, 603.

- कोलियैती *koliatti*, 1219.
 कोलियैती अशानी *koliatti asāni*, 1219.
 कोल्हकर *kolhkarh*, 1194.
 कोल्हकर *kolhkar*, 1194.
 कोल्हपचरानी *kolhpachrāni*, 1194.
 कोल्हुषा *kolhua*, 1097.
 कोल्हुषा बैल *kolhua bail*, 1097.
 कोल्हवार *kolhuār*, 297, 300.
 कोहंगर *kohanrgar*, 578.
 कोहन्दा *koñhra*, 1071.
 कोहबर-*kohbar*, 1307, 1308, 1335,
 1358.
 कोहबरत *kohbara*, 1335.
 कोहचरौरी *konhrauri*, 1272.
 कोहार *kohār*, 572.
 कोहिया *kohiya*, 713.
 को *ko*, 655.
 कोरन *koīn*, 1045.
 कोरल *koīl*, 1076.
 कोरलखो *koīlkho*, 1075.
 कोच *konch*, 1045.
 कोचा *koncha*, 741.
 कोची *konchi*, 726, 741.
 कोठा *kotha*, 1240.
 कोठी *kothi*, 77, 79, 310, 365, 814,
 924, 1400; Appendix, 14.
 कोठीवाल *kothiwāl*, 1461.
 कोठी सोरा *kothi sora*, Appendix, 14.
 कोड़ *kor*, 867, 1009.
 कोड़ देब *kor deb*, 867.
 कोड़न *koran*, 824, 865, 866, 1006,
 1009.
 कोड़पक्का *konrpakka*, 1182.
 कोड़न *korab*, 865, 981.
 कोड़ल *korāl*, 1009.
 कोड़ा *kora*, 104, 1007.
 कोड़ी *kori*, 834.
 कोड़ा *konrha*, 170, 414.
 कोढ़ि *korhi*, 841, 886 (footnote),
 1098.
 कोढ़ि बरद वें फेफरि बहत *korhi barad
 keñ phephari bahut*, 841.
 कोही *korhi*, 379, 799.
 कोदर कटा *kodar katta*, 1456.
 कोदो *kodo*, 990, 992, 1089.
 कोन *kon*, 128 (footnote), 604, 828.
 कोना *kona*, 828.
 कोना कोनी *kona koni*, 828.
 कोनी *koni*, 828.
 कोपिन *kopin*, 726.
 कोपीन *kopin*, 726.
 कोबी *kobi*, 1073.
 कोर *kor*, 866, 1271.
 कोरन *koran*, 866.
 कोरा *kora*, 104, 788, 1258.
 कोरा बाल *kora bāl*, 788.
 कोरी *kori*, 1053, 1143.
 कोरी करब *kori karab*, 1143.
 कोरो *koro*, 367, 1050, 1051, 1258.
 कोल *kol*, 1456.
 कोला *kola*, 832.
 कोली *koli*, 832.
 कोल्ह *kolh*, 250, 265.
 कोल्हु *kolhū*, 250, 265.
 कोस *kos*, 1492.
 कोसा *kosa*, 984.
 कोसी *kosi*, 959.
 कोसम *kosum*, 1043.
 कोषा *koha*, 139, 430, 432, 442,
 713.
 कोही *kohi*, 139, 140.
 कोषारा *kauara*, 1183.
 कोरना *kaurna*, 138.
 कोरेना *kaurena*, 372.
 कौवल *kauāl*, 1256.
 कौषा *kaua*, 356, 792, 870, 957,
 1398.
 कौषा अपान *kaua jhapān*, 957.
 कौषा बाँज *kaua bānjh*, 1398.
 कौषा लुकान *kaua lukān*, 957.

कौचा कौच *kaucha hānkab*, 870.
 कौड़ *kaur*, 1247.
 कौड़ी *kauri*, 1201, 1391, 1496.
 कौनी *kauni*, 988, 1045.
 कौम *kaum*, 1125.
 कौर *kaur*, 1078, 1247, 1271.
 कौर जाग्रव *kaur jāēb*, 1078.

कौरी *kauri*, 1143, 1256.
 कौरी करव *kauri karab*, 1143.
 कौल्हा *kaulha*, 1247.
 क्या *kya*, 1091.
 क्यौंचा *kyoncha*, 74.
 कृत्तिका *krittika*, 1082, 1084.
 कृष्ण *kriahn*, 1456.

॥ ख kh ॥

खई *khai*, 833.
 खखड़ी *khankhri*, 1074.
 खखरखरा *khankhrahra*, 669.
 खखरा *khakhra*, 894, 901.
 खखो न्नी *khakhorni*, 37, 328.
 खखोड़ी *khankhori*, 1161.
 खखोरन *khakhoran*, 1032.
 खखड़ा *khagra*, 1183.
 खगन्ना *khagra*, 379.
 खंगन्ना *khangra*, 379.
 खगन्नी *khagri*, 379.
 खगन्नीवा *khangriwa*, 1021.
 खंगावा *khangaāha*, 1172.
 खगूर *khagūr*, 226.
 खंचड़ा *kanchra*, 789.
 खंचिया *khanchiya*, 43, 44.
 खचोली *khacholi*, 44.
 खचड़ *khachchar*, 1128.
 खजन्ना *khajla*, 1272.
 खजन्ना *khajwa*, 1263.
 खजाना *khajāna*, 188, 321, 916, 919,
 952, 1207.
 खजूर *khajūr*, 585f, 1272.
 खजा *khāja*, 1174.
 खटार *khatāi*, 1003, 1272.
 खटिया *khatiya*, 636, 1416.
 खटुला *khatula*, 636.
 खटोला *khatola*, 636, 1457.
 खटोली *khatoli*, 636.
 खट्टा *khatta*, 1272.

खट्टा *khaddha*, 34.
 खट्टी *khaddhi*, 20.
 खड़ *khār*, 1234.
 खंड *khanr*, 832, 865.
 खड्कडा *kharkatta*, 915.
 खड्गगर्ना *khanrgarna*, 314.
 खड्गखर *kharchar*, 277.
 खड्गखर *khanrchar*, 259, 277.
 खड्गखारी *khanrchāri*, 259.
 खड्गमा *kharma*, 319k.
 खड्गमोड़ा *khanrmora*, 915.
 खड्गवावा *kharrwāha*, 915.
 खड्गवावा *khanrwāha*, 915, 945.
 खड्गखर *khārhar*, 1234.
 खड्गखर *khārha*, 8.
 खड्गखर *kharrhu*, 919.
 खड्गखर *khanrsār*, 312.
 खड्गखारी *khanrsāri*, 312.
 खड्गखन *kharrān*, 735.
 खड्गखौ *kharrān*, 735.
 खड्गखल *khara tāl*, 890.
 खड्गखर *khanrār*, 578.
 खड्गखर *kharrān*, 735.
 खड्गखर *khanruār*, 945.
 खड्गखर *kharruka*, 1075.
 खड्गखर *khanraura*, 1272.
 खड्गखर *kharrhaur*, 815.
 खड्गखर *kharrhaul*, 815.
 खण्ड *khand*, 832.
 खतखस *khatkas*, 404.

खतना *khatna*, 386, 1415.
 खतिवौनी *khatiyauni*, 1463d.
 खत्ता *khatta*, 77, 833.
 खदगौर *khadgaour*, 850.
 खदधा *khadha*, 34.
 खदिवापोल *khadiyāöl*, 1006.
 खदुका *khaduka*, 1461, 1477, 1481.
 खदोना *khadona*, 721.
 खदौड़ *khadaur*, 848, 850.
 खदौड़ केत *khadaur khet*, 850.
 खदौर *khadaur*, 850.
 खदुक *khadduk*, 1461, 1477, 1481.
 खदुी *khaddhi*, 848.
 खधा *khadha*, 77.
 खधेल *khadhel*, 1145.
 खंधौड *khandhaut*, 832.
 खन *khan*, 1194.
 खनञ्जौर *khanyjir*, 924.
 खनन *khanan*, 165.
 खनसारी *khansāri*, 646.
 खनखन *khanhan*, 165.
 खनिज *khanit*, 1493.
 खन्ता *khanta*, 833, 1493.
 खन्ती *khanti*, 39, 40.
 खन्ध *khandh*, 832.
 खन्धा *khandha*, 832.
 खपन्डा *khapra*, 319, 437, 713, 924,
 1262, 1399.
 खपन्डो *khapri*, 319, 437, 713.
 खपन्डोइया *khaproiya*, 1074.
 खपन्रा *khapra*, 924, 1246.
 खपन्रा पेरब *khapra pherab*, 1246.
 खपन्री *khapri*, 713, 1422.
 खपन्रोइया *khaproiya*, 1074.
 खपन्रोइो *khaprauri*, 713, 1401.
 खपन्रोर *khapraur*, 1401.
 खपन्रोर फेंकार *khapraur phenkää*,
 1401.
 खपियार *khapiyār*, 646.
 खंबीरा *khambira*, 468.

खबौनी *khabauni*, 1272.
 खभार *khabhār*, 921, 1125.
 खंबिया *khambhiya*, 765.
 खमन्चो *khamso*, 392.
 खमीरा *khāmira*, 468, 1021, 1023.
 खम्भा *khambha*, 414, 431, 609, 933,
 940, 1051, 1256.
 खम्बिया *khambhiya*, 1256.
 खम्बी *khambhi*, 1256.
 खम्हरवा *khamharua*, 1058.
 खम्हा *khamha*, 473, 940.
 खम्हां *khamhāñ*, 1256.
 खम्हार *khamhār*, 890, 986.
 खम्हिया *khamhiya*, 1256.
 खर *khar*, 367, 539, 815, 1010.
 खरई *kharai*, 815, 896, 1052.
 खरन्कुटी *kharkūti*, 363.
 खरन्को झुंडा *kharko khūnta*, 363.
 खरन्कोटी *kharkoti*, 1253.
 खरन्कौड *kharkaut*, 363.
 खरन्कौटी *kharkauti*, 363.
 खरन्कण्डा *kharkhanda*, 669.
 खरन्करिया *kharkhariya*, 248.
 खरन्गोस *khargos*, 740.
 खरन्च *kharch*, 1207, 1463d.
 खरन्चराइ *kharcharāi*, 1151.
 खरन्चरी *kharchari*, 1151.
 खरन्चा *kharcha*, 1052, 1207.
 खरन्चाक *kharchāk*, 1084.
 खरन्चाँड़ी *kharchāñri*, 277.
 खरन्चारो *khanrchāro*, 277.
 खरन्चाली *kharchāli*, 259, 277.
 खरन्धूषा *kharthūa*, 1075.
 खरन्पा *kharpa*, 735.
 खरन्बटाइ *kharchatāi*, 913.
 खरन्बुजा *kharchūja*, 1065.
 खरन्वन *kharcān*, 1204.
 खरन्वा *kharcā*, 816.
 खरन्वाच *kharcāch*, 858.
 खरन्वाचा *kharcācha*, 915, 945.

खरवे *kharwe*, 549, 858.
 खरवेच *kharwek*, 858
 खरवान *Kharsān*, 539, 1024.
 खरवर बावग *kharhar bāwag*, 858.
 खरवरा *kharhara*, 55, 57, 465.
 खरवरो *kharharo*, 57.
 खरहिवा *kharhiya*, 125.
 खरही *kharhi*, 1051.
 खरहर *kharahur*, 815.
 खराडोनि *kharāṇi*, 735.
 खराड *kharāt*, 549.
 खराद् *kharād*, 406, 469, 557.
 खरादी *kharādi*, 406.
 खराम *kharām*, 735.
 खरिका *kharika*, 1310.
 खरिकौवा *kharikauta*, 1253.
 खरित *kharit*, 850.
 खरिदगी *kharidgi*, 1209d, 1215.
 खरिदार *kharidār*, 1214.
 खरिहम *kharihan*, 1188.
 खरिहान *kharihān*, 879, 1090.
 खरिहानी *kharihāni*, 879, 914, 1194,
 1196, 1197, 1200.
 खरो *khari*, 250, 480, 1424.
 खरोद् *kharid*, 1040.
 खरवा *kharua*, 467.
 खरुवा *kharuka*, 740, 1074.
 खरुकी *kharuki*, 740.
 खरुहन *kharuhan*, 864.
 खरुहान *kharuhān*, 982.
 खरुहो *kharuho*, 1124.
 खरेवा *kharaiya*, 125.
 खरेठा *kharaiṭha*, 815.
 खरैल *kharail*, 646.
 खरो घर *kharo ghar*, 1235.
 खर्रा *kharra*, 55, 57, 1182.
 खर्री *kharrī*, 263.
 खलकोरवा *khalkoīya*, 990.
 खलची *khālchi*, 713.
 खलचोरवा *khālchoīya*, 984.

खलकी *khālki*, 1139.
 खलतेदार *khāltedār*, 727.
 खलनी *khālṇi*, 520.
 खलवा *khālwa*, 790.
 खलार *khālār*, 790.
 खलितकी *khālītari*, 1119.
 खलिहानि *khālīhāni*, 912.
 खली *khālhi*, 263.
 खलहर *khālhar*, 790.
 खवांव *khawās*, 1184.
 खखख *khaskhas*, 362a.
 खखस *khaxam*, 1274.
 खखरा *khaxra*, 913, 1468 a and b,
 1470, 1471; Appendix, 8.
 खखरा दानाबन्दी *khaxra dānabandī*,
 1468a, 1470; Appendix, 1.
 खखरा बढार *khaxra bādāi*, 1468.
 खखरेवा *khaxraiya*, 362.
 खखस *khaxal*, 1080.
 खखिवा *khaxiya*, 373, 768.
 खखी *khaxsi*, 1121.
 खखी *khāṭsi*, 1121.
 खखक *khāik*, 1269.
 खखै *khāi*, 833.
 खख *khāu*, 1477.
 खख *khāe*, 1026.
 खखर *khānkar*, 920c, 921.
 खखंग *khāng*, 1174.
 खखंग *khāngan*, 165.
 खखंग *khāngal*, 1174.
 खखंच *khānch*, 318.
 खखचा *khāncha*, 44, 318, 319f, 459.
 खखची *khānchi*, 44, 319f.
 खखे खिदर *khaje khidar*, 1456.
 खखजा *khāja*, 1272.
 खखजाना *khājāna*, 916.
 खखजी *khānji*, 648.
 खखजी *khānjihi*, 44.
 खखट *khāt*, 636.
 खखटिन *khātin*, 966d.

खाँड़ *khāñr*, 919, 1014.
 खाँड़ी *khāñri*, 20, 740.
 खाँड़ो *khāñro*, 919.
 खाह *khārḥ*, 1082.
 खाही *khārhi*, 8, 20.
 खातठ *khāta*, 20.
 खातब *khātab*, 1461, 1477.
 खाना *khāta*, 8, 77, 269, 315, 319j,
 1462, 1463c, 1477.
 खाना बची *khāta bahi*, 1463c.
 खातिर *khātir*, 1192.
 खाद *khād*, 77, 849, 1008.
 खाँदन *khāndan*, 165.
 खादर *khādar*, 848, 849, 868.
 खाध *khādh*, 77.
 खाधा *khādha*, 77.
 खान *khān*, 251, 268, 1194.
 खानचा *khāncha*, 459, 467.
 खानदान *khāndan*, 1209e.
 खानन *khānan*, 165.
 खाना *khāna*, 394, 478, 1248, 1393,
 1398.
 खानी *khāni*, 1272.
 खाने बाग *khāne bāg*, 813.
 खाप *khāp*, 402, 1221.
 खापड़ *khāpar*, 437.
 खापरि *khāpari*, 713.
 खाब *khāb*, 399, 402.
 खाबड़ *khābar*, 792.
 खाबर *khābar*, 792.
 खाभर *khābhar*, 792.
 खाभल *khābhal*, 867.
 खाम *khām*, 1235.
 खामसो *khāmsō*, 392.
 खामा *khāma*, 431.
 खामी *khāmhi*, 1051, 1256, 1259.
 खाथ *khāy*, 250, 356, 1084, 1087,
 1113, 1269, 1272.
 खार *khār*, 1080.
 खारी *khāri*, 816.

खार *khāru*, 864, 982.
 खारवाँ *khāruān*, 1042.
 खाल *khāl*, 414, 790, 792, 1139.
 खावा *khāwa*, 713, 917.
 खाँवाँ *khāwān*, 833, 917, 953.
 खाविन्द *khāwind*, 1274.
 खास *khās*, 131 ; Appendix, 14.
 खासदान *khāsān*, 711.
 खासर *khāsar*, 1164.
 खिखोरना *khikhorna*, 493.
 खिखोरनी *khikhorni*, 493.
 खिङ्गा *khinga*, 445.
 खिंचरी *khinchri*, 963, 1272.
 खिंचनी *khinchni*, 145.
 खिचचा *khichcha*, 984.
 खिजाया *khijāya*, 963.
 खिखोरना *khidhorna*, 493.
 खिनौरी *khinauri*, 2, 825.
 खिनौरी के जोत *khinauri ke jot*, 825.
 खियाब *khiyāo*, 1338.
 खियौलें *khiyaulēn*, 1217.
 खिरकी *khirki*, 1249.
 खिरखियार *khirkhiyāi*, 1407.
 खिरखियौनी *khirkhiyāuni*, 1338.
 खिरचटार *khirchatāi*, 1407.
 खिरची *khirchi*, 402.
 खिरदान *khirdant*, 969.
 खिरवरा *khirawara*, 1002 (footnote),
 1272.
 खिरसा *khirsa*, 1164.
 खिरौरा *khiraura*, 1272.
 खिलकट *khilkat*, 797, 981.
 खिलकट्टी *khilkatti*, 797, 981.
 खिलन्ती *khilnti*, 402.
 खिलनट्टी *khilnatti*, 711.
 खिलनार *khilmār*, 795, 797, 981.
 खिलनवत *khilvat*, 1236.
 खिलनी *khilni*, 1192.
 खिलनोरना *khilhorna*, 493.
 खिलुवा *khilua*, 740.

- खिलोरणा *khilorna*, 493.
 खिलत *khillat*, 1209b.
 खिला *khilla*, 24.
 खिल्ली *khilli*, 711, 1055.
 खिषकत *khiskat*, 727.
 खीकी *khikhi*, 713.
 खीचन *khinchab*, 391.
 खीची *khinchi*, 1079.
 खीर *khir*, 1272, 1338, 1389, 1405.
 खीर खिषाव *khir khyāv*, 1338.
 खीरा *khira*, 533, 1070.
 खीरा खिची *khira bichchi*, 533.
 खीरि *khiri*, 1272.
 खील *khil*, 795, 797, 981.
 खील कोरब *khil korab*, 981.
 खील तोरब *khil torab*, 981.
 खील बेठाबोल *khil baithāöl*, 795.
 खील मारी *khil māri*, 1192.
 खुक्खा *khukkha*, 1076.
 खुक्खा *khukhsa*, 1183.
 खुक्खुड़ी *khukhuri*, 984.
 खुन्त्रा *khuntra*, 182, 244.
 खुन्त्री *khuntri*, 182, 185, 200.
 खुत्ला *khutla*, 764.
 खुत्ली *khutli*, 764.
 खुत्तरा *khutahra*, 2.
 खुन्तहरी *khuntahri*, 182.
 खुन्ततान *khuntātān*, 224.
 खुन्तिपुत्ति *khuntiputti*, 348.
 खुत्तिया *khutiya*, 728.
 खुत्तिया *khuntiya*, 1008, 1010, 1024.
 खुत्तिया अंगरका *khutiya angarkha*,
 728.
 खुत्तिला *khutila*, 764.
 खुन्तिहरी *khuntihri*, 182.
 खुन्तेहरा *khuntehra*, 825.
 खुन्तेहरी *khuntehri*, 182.
 खुत्ता *khutta*, 363, 431, 609.
 खुत्ती *khutti*, 489, 573, 764.
 खुन्ता *khunta*, 40, 213, 464, 609.
 खुन्दा *khunda*, 361.
 खुन्दी *khundi*, 361.
 खुद *khud*, 911.
 खुदकाशत *khudkāsh*, 911.
 खुदनी *khudni*, 27.
 खुदर *khudar*, 1048.
 खुदी *khuddi*, 1272.
 खुबिया *khubiya*, 764.
 खुम *khum*, 83.
 खुरका *khurka*, 1075.
 खुरखुन *khurkhun*, 1079.
 खुरचन *khurchan*, 1032.
 खुरचनी *khurchani*, 319h, 456, 1161.
 खुरचनी *khurachni*, 453.
 खुरचुनी *khurchuni*, 424, 512.
 खुरजी *khurji*, 129.
 खुरदर *khurdān*, 888.
 खुरदिवा *khurdiya*, 1208.
 खुरदिवा मालिक *khurdiya mālīk*, 1208.
 खुरदिवा *khurdiha*, 1208, 1214.
 खुरदिवा मालिक *khurdiha mālīk*,
 1208.
 खुरदोती *khurdonti*, 888.
 खुरदोनी *khurdauni*, 888.
 खुरनी *khurni*, 27.
 खुरपा *khurpa*, 59, 60, 306, 369, 481.
 खुरपियाना *khurpiyāna*, 866, 867.
 खुरपी *khurpi*, 61, 306, 328, 456,
 481, 486, 867.
 खुरफा *khurpha*, 1073.
 खुरमा *khurma*, 1272.
 खुरहा *khurha*, 1172.
 खुरा *khura*, 90.
 खुरी *khuri*, 90.
 खुश *khush*, 1040.
 खुशका *khushka*, 1272.
 खुशकी ठीका *khushki thika*, 1210.
 खुश खरीद *khush kharid*, 1040.
 खुशकी *khuski*, 788, 1040, 1272.
 खुशकत *khusbakat*, 1209d.

खुसबरी *khusbari*, 1073.
 खुषा *khūa*, 888, 891.
 खुंड *khūnt*, 726, 1141.
 खुंडा *khūnta*, 213, 223, 224, 239,
 330, 363, 414, 431, 464, 469,
 489, 538, 609, 932, 1142, 1419.
 खुंडा बघा *khūnta balla*, 319j.
 खुंटी *khūnti*, 32, 258, 260, 330,
 348, 401, 489, 573, 595, 621,
 932, 1008, 1010, 1039, 1194.
 खुंटा *khūnta*, 361.
 खुंटी *khūnti*, 361.
 खुम *khūm*, 713.
 खुर *khūr*, 383.
 खुरा *khūra*, 13, 78.
 खेखसा *khekhsa*, 1073.
 खेधन्दा *khendhra*, 637.
 खेधरा *khendhra*, 731.
 खेनरा *khenra*, 637.
 खेपान *khepān*, 289.
 खेरुका *kheruka*, 740.
 खेरुकी *kheruki*, 740.
 खेदार *khedāi*, 1198.
 खेसरा *khesra*, 959.
 खेसारी *khesāri*, 959, 999, 999n.
 खेदा *kherha*, 8, 965.
 खेदी *kherhi*, 820, 1404.
 खेदी *khenrhi*, 8.
 खेदी जोड़ाघ *kherhi jorāeb*, 1404.
 खेत *khet*, 69, 356, 797, 798, 827,
 832, 834, 850, 981, 1006, 1090,
 1120, 1435.
 खेत पथार *khet pathār*, 832.
 खेत बघार *khet badhār*, 832.
 खेत भोजनी *khet bhojni*, 1435.
 खेत भोज *khet bhaj*, 1435.
 खेत मास *khet mās*, 999.
 खेत मासु *khet māsu*, 999.
 खेती *kheti*, 832, 1456.
 खेती बारी *kheti bāri*, 832.

खेती भवानो *kheti bhavāni*, 1456.
 खेना *kheṇa*, 76.
 खेप *khep*, 646.
 खेवा *khewa*, 235 (footnote).
 खेया *kheya*, 8.
 खैचा *khaincha*, 44.
 खैची *khainchi*, 288.
 खैनी *khaini*, 1023, 1026.
 खैया *khaiya*, 1269.
 खैर *khair*, 1073.
 खैरा *khaira*, 1074.
 खैरात *khairāt*, 1209d, 1431.
 खैरी *khairi*, 1074.
 खैरान *khairān*, 844, 1188.
 खौरचा *khoīncha*, 984.
 खौरचा *khoīnchha*, 741, 941.
 खौरया *khoīya*, 290, 984, 1012, 1031.
 खौरया *khoīha*, 290.
 खोचका *khoechha*, 741.
 खोंखरी *khonkhri*, 984.
 खोंगचा *khongha*, 1172.
 खोंखरी *khonchri*, 77.
 खोजका *khojra*, 1076.
 खोटला *khotla*, 764.
 खोटली *khotli*, 241.
 खोडना *khorna*, 441.
 खोडनी *khorni*, 441.
 खोदार *khodāi*, 1431.
 खोदाणा *khodauna*, 303.
 खोमचा *khoncha*, 459, 467.
 खोंपका *khompā*, 879, 1234.
 खोंपकी *khompri*, 71, 879, 1234.
 खोबार *khobār*, 1125.
 खोभना *khobhna*, 40.
 खोभार *khobhār*, 1125.
 खोभारि *khobhari*, 1125.
 खोभिया *khobhiya*, 1272.
 खोरना *khornā*, 303, 441, 705.
 खोरनाठी *khornāthi*, 441.
 खोरनी *khorni*, 303, 441, 705.

खोरना *khorma*, 1272.
 खोरना *khorha*, 1172.
 खोराकी *khoraki*, 1209e.
 खोरासानी *kkorasāni*, 1073.
 खोरासानी खवारन *khorasāni jawān*,
 1073.
 खोरिया *khoriya*, 511.
 खोलक्रा *kholakra*, 582.
 खोलरी *kholri*, 990, 1031.
 खोलनी *kholni*, 520, 582.
 खोलनाया *kholnaiya*, 232.
 खोलमारिया *kholmariya*, 523.
 खोलसा *kholsa*, 97, 261.
 खोरिया *khohiya*, 290, 1012, 1031.
 खोवा *khoā*, 888, 891, 1167.
 खोरवा *khoiya*, 1272.
 खौरख *khōñichk*, 621.
 खोवा *khokha*, 1487.
 खोगीर *khogir*, 226.
 खोंच *khonch*, 269
 खोंची *khonchi*, 41.
 खोंचा *khonchha*, 741.
 खोज *khōj*, 1286.

खोड़ *khōr*, 1141.
 खोंरी *khonri*, 361.
 खोंहा *khonrha*, 8.
 खोदब *khodab*, 1379.
 खोना *khona*, 721.
 खोन्ही *khonhi*, 1248.
 खोंप *khomp*, 50, 79, 895, 1234.
 खोंप के मथनी *khomp ke mathni*, 895.
 खोंपी *khompi*, 895.
 खोभन *khobhan*, 40.
 खोभी *khobhi*, 1183.
 खोम *khom*, 1125.
 खोर *khōr*, 143, 284, 368, 713, 893,
 1461.
 खोरा *khōra*, 83, 284, 308, 690, 713.
 खोरिख *khōrish*, 1209c.
 खोरी *khōri*, 680.
 खोल *khol*, 22, 97, 156, 730, 933.
 खोला *khola*, 97, 261.
 खोली *khōli*, 223, 22.
 खोह *khoh*, 891.
 खौक *khauk*, 1461.
 खौकार *khaukār*, 1477.

॥ ग g ॥

गग *gae*, 1084.
 गंगटा *gangta*, 794.
 गंगटाहा *gangtāha*, 794.
 गंगटियाहा *gangtiyāha*, 794.
 गंगटी *gangti*, 794.
 गगरा *gagra*, 693, 711.
 गगरी *gagri*, 304, 432, 713, 786.
 गगरी केवाल *gagri kewāl*, 786.
 गङ्ग *gang*, 788.
 गङ्गट *gangat*, 794, 1266.
 गङ्ग बरार *gang barār*, 788.
 गङ्ग सिकस *gang sikast*, 788.
 गङ्गा *ganga*, 1451, 1456.
 गङ्गाक *gangāk*, 1451.

गङ्गा जल *ganga jal*, 1451.
 गङ्गा मार *ganga māi*, 1456.
 गच *gach*, 423.
 गच्छुली *gachhuli*, 814.
 गज *gaj*, 154, 471, 474, 477, 582,
 711, 1490, 1491, 1492.
 गजगड़ा *gajra*, 1073.
 गजपती *gajpati*, 977.
 गजपत्ता *gajpatta*, 975.
 गजबाक *gajbāk*, 102.
 गजबाग *gajbāg*, 102, 224.
 गजर *gajar*, 826, 959.
 गजर बजर *gajar bajar*, 959.
 गजर मसर *gajar masar*, 959.

- गजनरा *gajra*, 1073.
 गजरौडा *gajrauta*, 1144.
 गजरौडी *gajrauti*, 1144.
 गजवाह *gajwāh*, 646.
 गज्जी *gajhi*, 144.
 गजा *gaja*, 959.
 गजांड़ *gajānr*, 798.
 गजाड़ा *gajāra*, 40.
 गजा बजा *gaja baja*, 959.
 गंजिया *ganjiya*, 227.
 गजुर *gajur*, 1001.
 गञ्ज *ganj*, 224, 585.
 गञ्ज अफज्ज *ganj aphjūd*, Appen-
 dix, 2a.
 गञ्ज सितार *ganj sitāra*, 585.
 गडा *gatta*, 472, 1272.
 गड्डी *gatti*, 498.
 गंठीठ *ganthaut*, 1480.
 गठीरा *gathaura*, 770.
 गंङ्कसा *ganrkassa*, 236.
 गङ्किल्ली *garkilli*, 258.
 गङ्गड़ा *gargara*, 473.
 गङ्गनी *garni*, 365, 919, 1183.
 गंङ्मेखा *ganrmekha*, 932.
 गंङ्गरकटा *ganrārkatta*, 915.
 गङ्गरा *garra*, 1074.
 गंङ्गार *ganrsār*, 1008.
 गंङ्गसी *ganrsi*, 86.
 गङ्गड़ो *garharo*, 106.
 गङ्गर *garhar*, 1075.
 गंङ्गर *ganrhar*, 1183.
 गङ्गहवा *garharua*, 1183.
 गङ्गवा *garha*, 849.
 गंङ्गी *gandhi*, 1479.
 गड़ाड़ी *garāri*, 595.
 गड़ार *garār*, 1074, 1075, 1183.
 गड़ारी *garāri*, 940.
 गंड़ारी *ganrāri*, 62, 832, 833.
 गंड़ास *ganrās*, 86.
 गड़ांस *garāns*, 86.
 गंड़ासा *ganrāsa*, 86.
 गड़ांस *garānsa*, 86.
 गंड़ासी *ganrāsi*, 86, 88.
 गरिदार *gariyār*, 1183.
 गरिदास *gariyās*, 408.
 गरि *gari*, 147.
 गंरुवा *ganrua*, 924.
 गरिरी *gareri*, 488.
 गंर *ganrer*, 1183.
 गरिरी *gareñri*, 1150.
 गंरिरी *ganreri*, 1183.
 गरिरी *garauān*, 924.
 गरिरी *graunchhi*, 1183.
 गरहरो *garhro*, 1075.
 गरहार *garhāi*, 537.
 गरहें *garhen*, 568.
 गखा *ganda*, 823, 854, 1498.
 गखा धार *ganda dhār*, 1007.
 गतान *gatān*, 120, 122, 639.
 गतार *gatār*, 938.
 गतास *gatāl*, 1477.
 गतास चाता *gatāl khāta*, 1477.
 गतौरा *gataura*, 120.
 गत्ती *gatti*, 713.
 गत्तो *gatto*, 614, 621.
 गदपंड़ोवा *gadpanroa*, 1183.
 गदपिड़ोड़ा *gadpirora*, 1183.
 गदपुरना *gadpurna*, 1183.
 गदरा *gadra*, 877.
 गदराप्रब *gadradēb*, 1004.
 गदराप्रस *gadradēl*, 957, 1001.
 गदराप्रस है *gadradēl hai*, 957.
 गदवा *gadha*, 105 (footnote), 393,
 1128.
 गदवा के बच्चा *gadha ke bachcha*, 1128.
 गदहिया *gadahiya*, 1074, 1263.
 गदही *gadhi*, 1074, 1128.
 गदहेंरी *gadhenri*, 1128.
 गदी *gadi*, 226.
 गदीना *gadina*, 1073.

- गदेबा *gadela*, 127, 213, 223, 1131.
 गंदौरा *gandaura*, 848.
 गदा *gadda*, 127, 209, 213, 877,
 940.
 गद्दी *gaddi*, 125, 126, 127, 223,
 226, 213, 371, 414, 451, 531,
 602, 1131.
 गद्दीवान *gaddiwan*, 371.
 गधपुरना *gadhputna*, 1183.
 गंधवा *gandhwa*, 1074.
 गन्ना बबब *ganna banab*, 1343.
 गनेस *ganes*, 1203.
 गनौरा *ganaura*, 848.
 गन्धकी *gandhki*, 1074.
 गन्धी *gandhi*, 1074.
 गपन्ताछ *gaptal*, 1477.
 गपन्तुचा *gaptua*, 1074.
 गपन्तू *gaptu*, 1074.
 गपन्स *gapsu*, 1074.
 गब्या *gabya*, 1157, 1272.
 गभन्तू *gabhtu*, 1074.
 गंभन्री *gambhri*, 965.
 गभःरू *gabhrū*, 1281.
 गभा *gabha*, 957.
 गभा भेख बा *gabha bhail ba*, 957.
 गभौरी *gabhauri*, 894.
 गमन्हा *gamchha*, 724, 733.
 गमन्ही *gamchhi*, 733.
 गमन्हा *gamla*, 713.
 गमन्हेर *gamher*, 301.
 गमन्हा *gamhra*, 957.
 गमन्हा भेख बहि *gamhra bhel bhi*,
 957.
 गमन्ही *gamhri*, 965.
 गया *gaya*, 1091.
 गयाळ *gayal*, 1477.
 गयाळ खाता *gayal khata*, 1477.
 गर *gar*, 1098.
 गर चौमन्वा *gar aundha*, 113.
 गरन्की *garki*, 912, 1230.
 गरन्की परन्नी *garki parti*, 912.
 गरन्जे *garje*, 1087.
 गरन्जे *garjai*, 1087.
 गरन्दी *garandi*, 919.
 गरन्दी *gardani*, 889.
 गरन्स *gardam*, 113.
 गरन्दावानी *gardawani*, 261, 765.
 गरन्दावक *gardanak*, 1251.
 गरन्दावो *gardani*, 261.
 गरन्दावो *gardami*, 261.
 गरन्दाव *gardanu*, 113, 889.
 गरब खिळा *garab khilla*, 155.
 गरन्नी *garmi*, 1092, 1083.
 गरळ *garal*, 1272.
 गरन्ही *garhi*, 765.
 गरस *garah*, 1252.
 गरसगर *garahgar*, 1252.
 गरन्हर *garhar*, 106.
 गरन्ही *garhi*, 1207.
 गरन्ही खरन्वा *garhi kharcha*, 1207.
 गरंगळ *garangat*, 794.
 गरन्ही *garanri*, 919.
 गरामन्ता *garamta*, Appendix, 126.
 गरारी *garari*, 595.
 गरियर *gariar*, 1098.
 गरिया *gariya*, 1014.
 गरौब *garib*, 414.
 गरे *gare*, 781.
 गरौंवा *garaundha*, 889.
 गरौमन्चम *garaundhan*, 113.
 गर्रा *garra*, 423.
 गळन्धोर *galkhor*, 113.
 गळन्जिन *galjin*, 724.
 गळन्जोती *galjoti*, 196.
 गळन्डे *galthai*, 1143.
 गळन्डे करब *galthai karab*, 1143.
 गळन्ता *galta*, 402.
 गळन्बळ *galbal*, 1272.
 गळन्मोक्ष *galmochha*, 724.
 गळस *galal*, 1004.

- गलसडन्का *galsatka*, 765.
 गलसेदी *galsedi*, 1316.
 गलही *galhi*, 235.
 गलियारी *galiyāri*, 489, 621.
 गलौचा *galcha*, 750.
 गलौवा *galaicha*, 750.
 गलौची *galaudhi*, 724.
 गलौचो *galausi*, 621.
 गलार *gallar*, 585.
 गला *galla*, 890, 1468a, 1470, 1472, 1484.
 गली *galli*, 489, 621, 832.
 गंबन्का *ganukha*, 1011.
 गवत *gawat*, 1144.
 गवतन्चोर *gawatchor*, 1146.
 गवान *gawan*, 1291, 1294.
 गवन्ना *gawna*, 1291.
 गवा *gawa*, 1435.
 गवा लगारव *gawa lagāēb*, 1435.
 गवा लेव *gāwa leb*, 1435.
 गवैयाँ *gawaiñyāñ*, 1207.
 गवैयाँ खरन्च *gawaiñyāñ kharch*, 1207.
 गहनी *gahni*, 234.
 गहरा *gahra*, 800.
 गहवा *gahua*, 411, 516, 552.
 गहरी *gahūi*, 516.
 गहम *gahum*, 955.
 गहमन *gahuman*, 1136.
 गहमा *gahuma*, 972, 985, 987.
 गहली *gahuli*, 516.
 गहेरुँ *gahenr*, 1124.
 गहैँ खरन्च *gāñ kharch*, 1207.
 गच्छ *gāchh*, 585f, 994, 995.
 गच्छी *gāchhi*, 813, 814, 862, 990, 1001.
 गाँज *gānj*, 48, 646, 890, 894, 986.
 गाजड़ *gājar*, 1073.
 गाजर *gājar*, 1016, 1144.
 गाजा *gāja*, 318.
 गाँजा *gānja*, 44, 48, 1036.
 गाँजी *gānji*, 646.
 गाजी जीवाँ *gāji miyān*, 1456.
 गाँडा *gānta*, 1480.
 गाँठ *gānth*, 1480.
 गाँठा *gāntha*, 1480.
 गाँर *gānrar*, 1075, 1183.
 गाड़ा *gāra*, 147, 150, 201, 1008.
 गाड़ी *gāri*, 147.
 गार *gār*, 858.
 गारहा *gārha*, 858.
 गारत *gāt*, 120.
 गारता *gāta*, 38.
 गाँती *gānti*, 740.
 गाद *gād*, 790, 1001.
 गारद *gādar*, 877.
 गारदा *gāda*, 877, 1001.
 गारदुर *gādur*, 1074.
 गाँधी *gāndhi*, 1074.
 गामिन *gābhīn*, 1116.
 गाम *gām*, 394.
 गाय *gāy*, 604, 1094, 1114, 1159.
 गाय गोरु *gāy goru*, 1094.
 गार *gār*, 829, 951, 952.
 गारा *gāra*, 423, 1267.
 गारु *gāl*, 921, 990, 1002 (footnote), 1317.
 गारु सेंकी *gāl senki*, 1317.
 गाली *gāli*, 489, 621, 729.
 गाँव के खरन्च *gānw ke kharch*, 1207.
 गाँव के ठाकुर *gānw ke thākur*, 1208.
 गावा *gāwa*, 1435.
 गासी *gāsi*, 13.
 गाही *gāhi*, 884.
 गिड़ी *gitti*, 1267.
 गिहाना *girhāna*, 1010.
 गिनव *ginab*, 1343.
 गिराँ *girain*, 1480, 1481.
 गिरन्मिठिया *girgitiya*, 1037.
 गिरन्गिरा *girgira*, 646.

- गिरधर *girdhar*, 655.
 गिरदा *girda*, 399, 459, 924.
 गिरमिड *girmit*, 400, 405.
 गिरमी *girmi*, 1480, 1481.
 गिरल *giral*, 1080.
 गिरनी *girwin*, 1480.
 गिरस्तु *girastu*, 1160.
 गिरस्तु घ्यु *girastu ghyu*, 1160.
 गिरह *girah*, 100, 1491.
 गिरहस्त *girhast*, 1085.
 गिरही *girhi*, 1234.
 गिराबी *girābi*, 239.
 गिरामी *girāmi*, 239.
 गिरेह *gireh*, 1010, 1491.
 गिरे *gire*, 1010, 1491.
 गिरी *giron*, 1477, 1480.
 गिरी गौड *giron gānth*, 1480.
 गिलदाजी *gilandāji*, 1493.
 गिलावा *gilāwa*, 423, 1246, 1267.
 गिलास *gilas*, 691.
 गिलेफ *gileph*, 730.
 गिलेवा *gilewa*, 1267.
 गिलाुरी *gilauri*, 1055.
 गौंगड *gingat*, 1266.
 गौर *gir*, 965a.
 गुगुल *gugul*, 1419.
 गुच्छा *guchchha*, 233.
 गुजर *gujar*, 69.
 गुजरात *gujrāt*, 1087.
 गुजरी *gunjri*, 533.
 गुजुरवा *gujurua*, 270.
 गुंजेरा *gunjera*, 1183.
 गुडरा *gudra*, 975.
 गुड *gur*, 1014.
 गुडकी *gurki*, 372, 713.
 गुडगुडी *gurguri*, 473.
 गुडिया *guriya*, 188, 204, 221.
 गुडडा *gurura*, 1451.
 गुडौर *guraur*, 300.
 गुही *gurhi*, 119.
 गुह *gund*, 886.
 गुण्डो *gundo*, 894.
 गुडरा *gudra*, 637.
 गुडर *gudar*, 1048.
 गुडरा *gudra*, 731.
 गुडरी *gudri*, 731, 1048.
 गुडशता *gudashṭa*, 1216.
 गुडशताहार *gudashṭadār*, 1216.
 गुडशा *gudasta*, 1216.
 गुडशाहार *gudastādār*, 1216.
 गुडार *gudār*, 874, 886.
 गुडारा *gudāra*, 874.
 गुन *gun*, 747, 1457.
 गुनधारी *gunthāri*, 638.
 गुनरखा *gunarkha*, 238.
 गुनवाह *gunwāh*, 239.
 गुनिया *guniya*, 426.
 गुनियान *guniyān*, 404, 426.
 गुनी *guni*, 1453.
 गुनी *gunni*, 1343.
 गुम्मा *gumma*, 1272.
 गुर *gur*, 1014.
 गुरखा *gurkha*, 238.
 गुरचलना *gurchalna*, 606.
 गुरदान *gurdan*, 309.
 गुरदाम *gurdam*, 309, 819, 457.
 गुरदावान *gurdawān*, 1141.
 गुरदेह *gurdel*, 66.
 गुरपौर *gurpaur*, 310.
 गुरहन्दी *gurhandi*, 314.
 गुरहत्तन *gurhatthan*, 1325.
 गुरहत्थी *gurhatthi*, 1325, 1347.
 गुरही *gurhi*, 120.
 गुरज *guruḥ*, 402.
 गुरज चाप *gurujkhāp*, 402.
 गुरौधा *guraudha*, 1341.
 गुरौंधा *guraundha*, 1325.
 गुल्गुला *gulgula*, 1272.
 गुल्थियाप्र *gulthiyāp*, 1024.
 गुल्दाना *gulḍāna*, 1272.

- गुल्गुन्दार *guldār*, 1138.
 गुल्गुन्धा *gulpha*, 1073.
 गुल्गुन्धी *gulphi*, 398.
 गुल्गुन्मिरिच *gulmirich*, 1073.
 गुल्गुन्गुल *gulāb*, 1043, 1272.
 गुल्गुन्गुल जामुन *gulāb jāmun*, 1272.
 गुल्गुन्गुली *gulābi*, 1043.
 गुल्गुन्गुली *guleti*, 66.
 गुल्गुन्गुरा *gulaura*, 1272.
 गुल्गुन्गुला *gulla*, 1012.
 गुल्गुन्गुली *gulli*, 32, 398, 602, 929, 932,
 936, 1008, 1012, 1042, 1272.
 गुल्गुन्गुन्ज *gūnj*, 469.
 गुल्गुन्गुर् *gūr*, 1014, 1399, 1404, 1409.
 गुल्गुन्गुर्क *gūrak*, 719.
 गुल्गुन्गुन्ना *gūnra*, 886.
 गुल्गुन्गुन्नी *gūnri*, 898, 1023.
 गुल्गुन्गुर्हा *gūrha*, 110, 233.
 गुल्गुन्गुन् *gūn*, 115, 239.
 गुल्गुन्गुर् *gūr*, 311, 373, 1014, 1324.
 गुल्गुन्गुरी *gūri*, 1272.
 गुल्गुन्गुञ्जोरन *gethjoran*, 1331.
 गुल्गुन्गुथिया *gethiya*, 128.
 गुल्गुन्गुन्धीला *genrchhila*, 292.
 गुल्गुन्गुन्धिवा *genrwahiya*, 292.
 गुल्गुन्गुन्धरवा *gerharua*, 1075.
 गुल्गुन्गुन्धारी *genrāri*, 832.
 गुल्गुन्गुन्धिकाटा *genrikāta*, 293.
 गुल्गुन्गुन्धिया *geriya*, 549.
 गुल्गुन्गुन्धियार *geriyār*, 281.
 गुल्गुन्गुन्धियार *genriyār*, 298.
 गुल्गुन्गुन्धियारी *genriyāri*, 281, 298.
 गुल्गुन्गुन्धुवा *gerua*, 688.
 गुल्गुन्गुन्धुवा *genrua*, 652.
 गुल्गुन्गुन्धुवावा *geñruāwa*, 1263.
 गुल्गुन्गुन्धुनी *genruri*, 652.
 गुल्गुन्गुन्धुली *genruli*, 652.
 गुल्गुन्गुन्धुद्रा *gendra*, 637.
 गुल्गुन्गुन्धुद्रा *gendra*, 731.
 गुल्गुन्गुन्धुनी *genhri*, 1073.
 गुल्गुन्गुन्धारी *genhāri*, 1073.
 गुल्गुन्गुन्धुवा *gerua*, 119, 637, 1074.
 गुल्गुन्गुन्धुवा *gerui*, 1074, 1089.
 गुल्गुन्गुन्धुवा *gelhanta*, 1073.
 गुल्गुन्गुन्धुवा *gelāh*, 1070.
 गुल्गुन्गुन्धुवा *gelai*, 1477.
 गुल्गुन्गुन्धुवा *gelainhi*, 1486.
 गुल्गुन्गुन्धुवा *gelhni*, 37.
 गुल्गुन्गुन्धुवा *genhriwāla*, 1156.
 गुल्गुन्गुन्धुवा *gehuñ*, 955.
 गुल्गुन्गुन्धुवा *genhuān*, 985.
 गुल्गुन्गुन्धुवा *gehuma*, 985.
 गुल्गुन्गुन्धुवा *gehūn*, 1092.
 गुल्गुन्गुन्धुवा *getam*, 637.
 गुल्गुन्गुन्धुवा *genth*, 1331.
 गुल्गुन्गुन्धुवा *geñth jor*, 1331.
 गुल्गुन्गुन्धुवा *genth bandhan*, 1331.
 गुल्गुन्गुन्धुवा *gentha*, 108.
 गुल्गुन्गुन्धुवा *geñthi*, 1357.
 गुल्गुन्गुन्धुवा *genr*, 1010, 1012, 1144.
 गुल्गुन्गुन्धुवा *genra*, 873, 1008.
 गुल्गुन्गुन्धुवा *genra karal*, 873.
 गुल्गुन्गुन्धुवा *genri*, 288, 1008.
 गुल्गुन्गुन्धुवा *gend khelab*, 1386.
 गुल्गुन्गुन्धुवा *geru*, 786.
 गुल्गुन्गुन्धुवा *gel*, 115 (footnote); 444, 859,
 922, 967, 987, 1004, 1043,
 1086, 1087, 1089, 1343, 1485.
 गुल्गुन्गुन्धुवा *gelha*, 141, 719, 1160.
 गुल्गुन्गुन्धुवा *gelha ke ghyu*, 1160.
 गुल्गुन्गुन्धुवा *gaighara*, 1153.
 गुल्गुन्गुन्धुवा *gainch*, 1256.
 गुल्गुन्गुन्धुवा *gaincha*, 38.
 गुल्गुन्गुन्धुवा *gainta*, 38, 39, 115.
 गुल्गुन्गुन्धुवा *gainti*, 38.
 गुल्गुन्गुन्धुवा *gaidān*, 1347.
 गुल्गुन्गुन्धुवा *gaina*, 1099.
 गुल्गुन्गुन्धुवा *gaiya*, 1087.
 गुल्गुन्गुन्धुवा *gair*, 1215.
 गुल्गुन्गुन्धुवा *gair maurāsi*, 1215.

- गेह *gail*, 957, 1092, 1094, 1294,
 1477, 1485.
 गेह खाना *gail khāta*, 1477.
 गेवाह *gaiwāh*, 1150.
 गोखाम *goām*, 919, 1201.
 गोघार *goār*, 1084, 1150, 1203.
 गोघारक *goārak*, 849 (footnote).
 गोघारें *goāren*, 1159.
 गोघास *goās*, 1132.
 गोरेठा *goītha*, 1139.
 गोरठा *goītha*, 852, 853.
 गोरेँठा *goīntha*, 852.
 गोरठा घर *goītha ghar*, 853.
 गोरेँड़ *goēnr*, 784.
 गोरेँड़ा *goēnra*, 784.
 गोखन्खू *gokhlu*, 533.
 गोखुला *gokhula*, 753, 1075.
 गोखई *gojai*, 959.
 गोमन्बौटा *gojhnauta*, 741.
 गोमिखा *gojhiya*, 1272.
 गोडाप्रह *gotāēl*, 957.
 गोठहल *gothahul*, 853.
 गोठौर *gothaur*, 853.
 गोठौरा *gothaura*, 853.
 गोठौल *gothaul*, 853.
 गोठौला *gothaula*, 853.
 गोठन्तार *gotār*, 638.
 गोठन्बोघार *godhoāi*, 1341.
 गोठन्पौठा *gorpauṭha*, 989.
 गोठन्पौर *gorpaur*, 941, 949.
 गोठन्घा *gorha*, 759.
 गोठ्णार *gorāin*, 759.
 गोठ्णामौ *gorāni*, 105, 110.
 गोठ्णान्व *gorānw*, 110, 759.
 गोठ्णान्व *gorāwan*, 110.
 गोठ्णार *gorār*, 110.
 गोठ्णिया *goriya*, 188, 224, 225, 228,
 690, 1256.
 गोठ्णैत *gorait*, 1200, 1209b ; Appen-
 dix, 12a.
 गोठ्णैतक *goraitak*, 1200.
 गोठ्णैतक वृत्त *goraitak mūth*, 1200.
 गोठ्णैतो *goraiti*, 1200.
 गोघार *gothār*, 1145.
 गोँदुरी *gondri*, 751.
 गोदान *godām*, 312, 1139, 1488.
 गोँदौरा *gondaura*, 848.
 गोधन्वा *godhna*, 1183.
 गोमन्तारी *gontāri*, 638.
 गोमन्री *gonri*, 751.
 गोमन्तौर *gonraur*, 848.
 गोमिखा *goniya*, 426.
 गोपाल भोग *gopāl bhog*, 975.
 गोबन्नाह *gobnāi*, 1456.
 गोबन्नाह राखत *gobnāi rāit*, 1456.
 गोबन्नाप्रह *gobnāēl*, 850.
 गोबन्तौरा *gobraura*, 1074.
 गोबारा *gobāra*, 585.
 गोभन्नी *gobhni*, 40.
 गोरन्मिखा *gorkhiya*, 845, 1150.
 गोरन्खुल *gorkhul*, 753, 1075.
 गोरन्ती *goranti*, 786.
 गोरन्धरिया *gorthariya*, 638.
 गोरन्धारी *gorthāri*, 638.
 गोरन्धारो *gorthāro*, 1145.
 गोरन्धार रन्धा *gordār randa*; 899
 गोरन्धार रन्धानी *gordār rukhāni*, 400.
 गोरन्बोघार *godhoāi*, 1400.
 गोरन्पौर *gorpaur*, 280.
 गोरन्पौरी *gorpauri*, 614.
 गोरन्घा *gorha*, 852, 853.
 गोरिखडा *goriatta*, 786.
 गोरिया *goriya*, 1456.
 गोरेखा *gorea*, 1456.
 गोरेँठिया *gorentiya*, 786.
 गोरेँठिया पन्धरौतो *gorentiya pathrauti*,
 786.
 गोरेखा *goraiya*, 1456.
 गोरौखा *goraudha*, 1341.
 गोखन्मन्था *golbhanta*, 1073.

गोलमुर्चा *golmukhān*, 523.
 गोलमुर्ची *golmukhīn*, 523.
 गोलवा *golwa*, 764, 768, 1135.
 गोलवर्ण *golvān*, 378.
 गोलसाबर *golsābar*, 549.
 गोलथथ *golhath*, 963.
 गोलथथी *golhatthi*, 963.
 गोलावा *golāwa*, 1073.
 गोलौर *golaur*, 297, 300.
 गोसाँई *gosāñī*, 1456.
 गोसाउन *gosāun*, 1175.
 गोसैँया *gosainya*, 393.
 गोहन्मा *gohma*, 970.
 गोहन्रा *gohra*, 852, 853.
 गोहन्राप्रथ *gohrāēb*, 1098.
 गोहन्तौर *gohraur*, 853.
 गोहन्तौरा *gohraura*, 853.
 गोहान *gohān*, 784.
 गोहार *gohār*, 1201.
 गोहाल *gohāl*, 1153.
 गोहिवा *gohiya*, 72, 1234.
 गोहूँ *gohuñ*, 955.
 गोहूम *gohum*, 955
 गोहूमन *gohuman*, 1136.
 गोषा *goa*, 653, 848, 868, 1006.
 गोषा पटाप्रथ *goa patāēb*, 1006.
 गोखुल *gokhul*, 975, 978.
 गोखुल फूल *gokhul phūl*, 975.
 गोखुल चार *gokhul sār*, 978.
 गोछा *gochha*, 233.
 गोछी *gochhi*, 1435.
 गोजर *gojar*, 69.
 गोजी *goji*, 654.
 गोषा *gojha*, 1272.
 गोण्डी *gonyhi*, 1010.
 गोट *got*, 604, 984, 1045, 1127.
 गोटा *gota*, 765, 856, 984, 1045.
 गोटी *goti*, 327, 1032, 1175.
 गोटी के निकसनारी *goti ke nīk sāri*,
 1175.

गोटी घर *goti ghar*, 327.
 गोटे *gota*, 1045.
 गोठी *gothi*, 337.
 गोठल *gothul*, 853.
 गोड़ *gor*, 356, 1341, 1350, 1451.
 गोँड़ *gonr*, 433.
 गोड़ धोर *gor dhoi*, 1341.
 गोड़ा *gora*, 78, 90, 362a.
 गोड़ी *gori*, 319j.
 गोँड़ी *gonri*, 93, 580.
 गोँड़ा *gonrha*, 784.
 गोद *god*, 1394.
 गोद लेब *god leb*, 1394.
 गोँदी *gondi*, 1251.
 गोधन *godhan*, 1446.
 गोण *gon*, 115, 128, 239.
 गोणर *gonar*, 849 (footnote), 849.
 गोप *gop*, 755.
 गोबर *goabar*, 848, 1445.
 गोबर पाँचे *goabar pānche*, 1445.
 गोभी *gobhi*, 1009, 1011, 1074.
 गोर *gor*, 1337, 1338, 1400.
 गोरख *gorakh*, 756, 769.
 गोरख चंभारी *gorakh dhandhāri*, 756.
 गोरख चन्धारी *gorakh dhanhāra*, 756,
 769.
 गोर लगनाप्रथ *gor lagāēb*, 1337, 1351.
 गोरस *goras*, 1157.
 गोरा *gora*, 1216.
 गोरी *gori*, 786.
 गोरी केवाल *gori kewāl*, 786.
 गोड़ *goru*, 1094.
 गोल *gol*, 236, 418, 748, 756, 769,
 921, 1037, 1073, 1113, 1135,
 1259, 1260.
 गोलक *golak*, 399, 400, 418.
 गोलक बुख खाव *golak buruj khāv*,
 399.
 गोलख *golakh*, 400, 418.
 गोल गाळ *gol gāl*, 921.

गोख त्रिरिच *gol mirich*, 1073.
 गोखकर *golammar*, 921.
 गोख रेती *gol reti*, 418.
 गोखा *gola*, 424, 466, 585, 1016,
 1113, 1135, 1259, 1260, 1272.
 गोखाकस *golākas*, 424.
 गोखा रुखानी *gola rukhāni*, 400.
 गोखी *goli*, 77, 498, 505, 549.
 गोखी सबरी *goli sabri*, 549.
 गोखस *gosal*, 1408, 1430.
 गोखस करारुष *gosal karāeb*, 1408,
 1430.
 गोखट *gohat*, 865.
 गोमन्हा *gautha*, 1144.
 गोमहरी *gaunahri*, 1293.
 गौरिवा *gauriya*, 991.
 गौरवा *gauraiya*, 473.
 गोसाहा *gausāla*, 1153.
 गोसिङ्गी *gausinghi*, 1102.
 गौ *gau*, 637, 1114, 1451.
 गौंवा *gauñāñ*, 1208.
 गौ किरिवा *gau kiriya*, 1451.
 गौ कोष *gau kos*, 1492.

गौखा *gaukha*, 1139.
 गौच *gauch*, 400.
 गौंची *gaunchi*, 789.
 गौंची *gaunchhi*, 789, 1074.
 गौठि *gauthi*, 848.
 गौठी *gauthi*, 848.
 गौंदा *gaunrha*, 784.
 गौत *gaut*, 848, 1144.
 गौत *gaunt*, 848.
 गौ तकिवा *gau takiya*, 637.
 गौत देव *gaut deb*, 1145.
 गौंती *gaunti*, 884.
 गौदान *gaudān*, 1347.
 गौना *gauna* 1291, 1349.
 गौना के बेचार *gauna ke neār*, 1349.
 गौर *gaur*, 1118.
 गौरी *gauri*, 93.
 गौवा *gaula*, 236.
 गौवार *gausār*, 1153.
 ग्राम *grām*, 1455.
 ग्राम देवोता *gram deota*, 1455.
 ग्वार *gwār*, 1150.
 गिही *grihi*, 1234.

॥ घ gh ॥

घरे *ghat*, 835.
 घग्घा *ghaggha*, 1084.
 घङ्घरा *ghanghra*, 743.
 घङ्घरी *ghaghri*, 34, 1088.
 घङ्घरी *ghanghri*, 743, 1074.
 घङ्घर *ghanghar*, 743.
 घटक *ghatak*, 1286.
 घटना *ghatna*, 3191, 718.
 घट्टरा *ghatra*, 1272.
 घट्टिन *ghatihan*, 1272.
 घटोरा *ghatora*, 1272.
 घट्टा *ghattha*, 1272.
 घट्टिन *ghathihan*, 1272.
 घटा *ghara*, 32.

घट्टारी *gharāri*, 832, 940.
 घट्टिया *ghariya*, 530, 547, 554, 560,
 621.
 घट्टी *ghari*, 595, 776.
 घट्टींची *gharaunchi*, 722.
 घण्ट *ghant*, 776, 1422.
 घण्ट टांगव *ghant tāngab*, 1422.
 घण्टा *ghanta*, 776.
 घन *ghan*, 397, 410, 552, 585, 858.
 घन चक्र *ghan chakkar*, 585.
 घनमुद्धी *ghanmudhi*, 409.
 घनववा *ghanbaha*, 295.
 घनववावा *ghanwāwa*, 283, 295.
 घनी *ghani*, 646.

- घनेली *ghanali*, 646.
 घर *ghar*, 268, 312, 853, 895, 1089,
 1162, 1234, 1235, 1244, 1248,
 1275, 1350, 1388, 1390.
 घरत *ghara*, 1234.
 घरन्का *gharka*, 1250.
 घर के लोग *ghar ke log*, 1275.
 घरन्वरन्वा *ghargharwa*, 1173.
 घर हरिया *ghar chhariya*, 1244.
 घरन्ने *gharna*, 232.
 घरन्नी *gharanni*, 566.
 घर पैसारी *ghar paisari*, 1350.
 घरन्बारी *gharbari*, 784.
 घर भरव *ghar bharav*, 1388, 1390.
 घरन्ना *gharra*, 271.
 घरन्नी *gharri*, 595.
 घरन्हु *gharhu*, 1092.
 घरा *ghura*, 1234, 1254.
 घरामी *gharami*, 1244.
 घरिया *ghariya*, 530, 547, 554, 557,
 713.
 घरिल *gharil*, 713.
 घरौ *gharo*, 1234.
 घलन्धरी *ghalthari*, 722.
 घलन्धारी *ghalsari*, 722.
 घलुचा *ghalua*, 1483.
 घसन्कट्टी *ghaskatti*, 1359.
 घसन्तुरिया *ghasturiya*, 1119.
 घसुचा *ghasua*, 1272.
 घसुई *ghasui*, 1272.
 घसुई रोटी *ghasui roti*, 1272.
 घार *ghāi*, 34.
 घाघ *ghāgh*, 1091, 1092.
 घांघर *ghāngar*, 743.
 घाघे *ghāghe*, 829.
 घाठ *ghāt*, 1420.
 घाठों *ghāton*, 1456.
 घाठ *ghāth*, 1272.
 घाठा *ghātha*, 1272.
 घाठि *ghāthi*, 1272.
 घाठो *ghātho*, 1272.
 घांठो *ghāntho*, 1272.
 घानी *ghāni*, 263, 444.
 घामँद *ghāmanr*, 487.
 घारी *ghāri*, 1153.
 घाघ *ghās*, 356, 868.
 घाघ पान *ghās pāt*, 868.
 घिचरा *ghiura*, 1069.
 घिधारी *ghidhāri*, 1308.
 घिना *ghina*, 848.
 घिघौड़ा *ghiyaura*, 1272.
 घिरन्ची *ghirchi*, 335f.
 घिरन्ने *ghirna*, 595.
 घिरन्ना *ghirna*, 596.
 घिरन्नी *ghirni*, 238, 595, 940.
 घिरन्सची *ghirsandi*, 722.
 घिरन्सिही *ghirsirhi*, 722.
 घिरन्सिन्दी *ghirsindi*, 722.
 घिरन्सिर *ghirsir*, 722.
 घिक्क *ghiwak*, 140.
 घिक्क कड़न्का *ghiwak karha*, 140.
 घिक्क कड़न्ची *ghiwak karhi*, 140.
 घिक्की *ghiwahi*, 140.
 घिक्की मँड़ा *ghiwahi bhānra*, 140.
 घिसिरी *ghisiri*, 722.
 घी *ghi*, 1160.
 घीव *ghiw*, 1160.
 घीवर *ghiwār*, 1272.
 घुघुरी *ghuguri*, 1272.
 घुग्वा *ghugga*, 741.
 घुघन्नी *ghughni*, 990, 1272.
 घुंघन्नी *ghunghni*, 990.
 घुंघन्हु *ghunghru*, 759.
 घुघुहु *ghughuru*, 771.
 घुंघुहु *ghunghuru*, 771.
 घुघुर *ghunghur*, 759.
 घुचौ *ghuchchi*, 713.
 घुण्डी *ghundi*, 612, 729, 767.
 घुमन्ची *ghunsi*, 755.
 घुमन्ची *ghumri*, 1177.

- घुमाप्रब *ghumāeb*, 830, 1098, 1332.
 घुमान *ghumān*, 954.
 घुमौषा जाळ *ghumaua jāl*, 646.
 घुरकडा *ghurkatta*, 292.
 घुरचो *ghurchi*, 335.
 घुरचोळा *ghurchiḷa*, 115.
 घुरन्वो *ghurni*, 940, 1177.
 घुरळा *ghurla*, 136.
 घुरिळी *ghurili*, 713.
 घुसिचाचे *ghusiāche*, 1446.
 घुषा *ghūa*, 984.
 घुघ *ghūgh*, 741.
 घुंकी *ghūnri*, 729.
 घुन *ghūn*, 1074.
 घुनी *ghūni*, 1024.
 घुर *ghūr*, 848, 849, 873, 1247, 1400.
 घुर काव्य *ghūr kātab*, 873.
 घुरी *ghūri*, 889.
 घेघुषा *gheghua*, 1173.
 घेवळी *ghebli*, 1000.
 घेरान *gherān*, 895, 1148.
 घेरानो *gherān*, 1148.
 घेवडा *ghewra*, 1069.
 घेवारी *ghewāri*, 832.
 घेंच *ghench*, 1073.
 घेरळ *gheral*, 1485.
 घेरा *ghera*, 895, 919, 1132, 1148, 1311.
 घेवर *ghewar*, 1272.
 घेव्हारी *ghailsāri*, 722.
 घैला *ghaila*, 83, 303, 432, 713.
 घैली *ghaili*, 713.
 घोंगरा *ghongra*, 1100.
 घोंघरी *ghonghri*, 1074.
 घोंघडणा *ghonghphulca*, 1173.
 घोंघरा *ghonghra*, 1100.
 घोंघना *ghonchica*, 1100.
 घोंटार *ghoñtāi*, 1310, 1314.
 घोडमुंवा *ghormuhān*, 1256.
 घोडसहा *ghorsaha*, 1256.
 घोडिया *ghoriya*, 225.
 घोवसार *ghonsār*, 434, 435.
 घोवसारी *ghonsāri*, 434.
 घोवजाउर *ghorjāur*, 1272.
 घोवजारी *ghorjāri*, 1272.
 घोवमाहा *ghormāha*, 143.
 घोराड *ghorāi*, 639, 936.
 घोराठी *ghorāthi*, 144.
 घोराण *ghorān*, 895, 1148.
 घोराणी *ghorāni*, 936.
 घोघ *ghogh*, 741.
 घोघट *ghoghat*, 741.
 घोघर *ghoghar*, 1458.
 घोघर *ghonghar*, 1100.
 घोघा *ghongha*, 725, 1267.
 घोघी *ghoghi*, 734, 737.
 घोघी *ghonghi*, 737.
 घोघो *ghogho*, 741.
 घोघा *ghoncha*, 1100.
 घोण्टब *ghoñtab*, 1310.
 घोडन *ghotan*, 1310.
 घोडा *ghonta*, 539.
 घोड *ghor*, 148, 1126.
 घोड बहल *ghor bahal*, 148.
 घोडा *ghora*, 1126.
 घोडी *ghori*, 386, 1126, 1127, 1256.
 घोपा *ghonpa*, 987, 1100.
 घोर *ghor*, 749, 1126, 1161, 1166, 1272.
 घोरन *ghoran*, 639.
 घोरा *ghora*, 1126.
 घोरी *ghori*, 1126.
 घोळ *ghol*, 1272.
 घोळी *gholi*, 1483.
 घोड *ghaud*, 379.
 घौर *ghaur*, 379, 1234.
 घ्युदारी *ghyudhāri*, 1308.
 घ्यु *ghyū*, 138, 713, 719, 1160, 1272, 1308.

॥ च ch ॥

चक *chak*, 629.
 चकट्टी *chakti*, 209.
 चकठ *chakath*, 1225, 1227.
 चकत्ती *chakti*, 209.
 चकन्मक *chakmak*, 1091.
 चकरन्वान *chakarvān*, 585.
 चकरन्वान *chakarsān*, 538.
 चकरी *chakri*, 581, 619, 932, 1014.
 चकला *chakla*, 457, 629.
 चकलेदार *chakledār*, 871.
 चकवर *chakvar*, 579.
 चकुला *chakula*, 619.
 चकैठ *chakaith*, 573.
 चकोड़ा *chakora*, 1183.
 चकोड़ी *chakori*, 579.
 चकोला *chakola*, 629.
 चक्कर *chakkar*, 360, 585, 590, 1112.
 चक्कस *chakkas*, 447.
 चक्का *chakka*, 151, 590, 1253, 1272.
 चक्की *chakki*, 581, 590, 619, 1014, 1251, 1369.
 चंगनी *changni*, 1483.
 चंगेरी *changeri*, 44.
 चंगेली *changeli*, 44.
 चंगोर *changor*, 45.
 चघूस *chaghūs*, 147.
 चघूस गाड़ी *chaghūs gāri*, 147, 150.
 चचरा *chachra*, 937.
 चचरी *chachri*, 1416.
 चचार *chachār*, 233, 937.
 चचार *chanchar*, 1234.
 चचार घर *chanchar ghar*, 1234.
 चटका *chatka*, 735.
 चटकोड़ा *chatkoha*, 1004.
 चटना *chatna*, 1458.
 चटनी *chatni*, 1272.
 चटार *chatāi*, 197, 751, 1450.

चटान *chatān*, 751, 794, 1266.
 चटावन *chatāvan*, 1407.
 चटिया *chatiya*, 1453.
 चटुवा *chatua*, 1458.
 चटनी *chataini*, 751.
 चटेल *chatail*, 1073.
 चहा *chatta*, 1004.
 चहा चरिच है *chatta dharis hai*, 1004.
 चहान *chattān*, 1266.
 चही *chatti*, 317, 304, 319m, 456, 713, 750.
 चठेल *chathail*, 1073.
 चरिया *chariya*, 713.
 चरियार *chariyār*, 949.
 चरिवाह *chanriwāh*, 949.
 चर *charh*, 1173.
 चरहत *charhat*, 1085.
 चरहब *charhab*, 1024.
 चराप्रब *charhāeb*, 1308, 1378.
 चराव *charāo*, 951.
 चरि *charhi*, 726 (footnote).
 चरु *chardu*, 1034.
 चतरा *chatra*, 1074, 1105.
 चतावन *chatāvan*, 1456.
 चतुरथी *chaturthi*, 1340, 1357.
 चंद्रौटा *chandrauta*, 778.
 चंदना *chandwa*, 7, 183.
 चंदिया *chandiya*, 269.
 चंदुली *chanduli*, 7.
 चहर *chaddar*, 323, 724, 730, 740, 1339, 1386.
 चमकी *chanki*, 786.
 चमडोल *chandol*, 241.
 चममार *chanmār*, 1251.
 चमवा *chanwa*, 269.
 चमसुर *chansur*, 1073.
 चना *chana*, 1002.

- चनाबक *chanābak*, 965c.
 चनी *chani*, 1003.
 चन्दन *chandan*, 778, 1318, 1391.
 चन्दन हार *chandan hār*, 1391.
 चन्दर *chandar*, 585.
 चन्दर कला *chandar kala*, 585.
 चन्दर हार *chandar hār*, 765.
 चन्ना *channa*, 1047, 1048.
 चपई *chapai*, 136, 1043.
 चपकान *chapkan*, 729.
 चपटना *chapatwa*, 1074.
 चपटा *chapta*, 735, 1037.
 चपोट *chapot*, 179.
 चपड़ा *chapra*, 1075.
 चपनी *chapni*, 492.
 चपन्रावन *chapraoan*, 409.
 चपन्रीना *chaprauna*, 409.
 चपन्रीनी *chaprauni*, 409.
 चबुतरा *chabutra*, 317, 1243.
 चबैना *chabena*, 1272.
 चबैनी *chabeni*, 1272.
 चहकी *chabhuki*, 99.
 चमच *chamach*, 449.
 चमड़ा *chamra*, 414, 1139.
 चमड़ी *chamri*, 719.
 चमकार *chamatkar*, 1056.
 चमरक *chamrakh*, 349.
 चमरा *chamra*, 362a.
 चमरुनि *chamāni*, 1400.
 चमार *chamār*, 479, 1196.
 चमैनी *chamāni*, 1400, 1408, 1412.
 चमौटा *chamauta*, 383.
 चमौटी *chamauti*, 383.
 चम्पा *champa*, 138, 140, 765.
 चम्पा कली *champa kali*, 765.
 चमच *chammach*, 449.
 चमाल *chammal*, 507.
 चर *char*, 1120.
 चरचनी *charanni*, 1479.
 चरक *charak*, 597, 1133.
 चरका *charaka*, 1133.
 चरको *charko*, 1133.
 चरक *charukh*, 498, 540, 598.
 चरका *charkha*, 339.
 चरकी *charkhi*, 329, 585a, 598.
 चरगोटिया *chargotiya*, 639.
 चरगोरी *chargori*, 31.
 चरचसी *charchasi*, 821.
 चरचिया *charanchhiya*, 1248.
 चरचिया चूल्हा *charanchhiya chulha*, 1248.
 चरन *charan*, 93.
 चरना *charna*, 726.
 चरनी *charni*, 93.
 चरन्पतिवा *charpatiya*, 1018.
 चरन्पतिबो *charpatiyo*, 1018.
 चरन्पलिया *charpaliya*, 725.
 चरन्पाई *charpāi*, 636, 1416.
 चरन्पाय *charpāy*, 243.
 चरन्बन *charban*, 1272.
 चरम्बरना *charbardha*, 1097.
 चरना *charwa*, 1126.
 चरनाच *charwāh*, 1150, 1184.
 चरगवाहा *charwāha*, 845, 1150.
 चरगवाही *charwāhi*, 833, 1152, 1205.
 चरस *charas*, 1036.
 चरसा *charsa*, 1139, 1201.
 चरसा के गोदाङ्ग *charsa ke godām*, 1139.
 चरसेरा *charsera*, 1500.
 चरसेरी *charseri*, 1500.
 चराई *charāi*, 1147, 1151, 1152, 1205 ; Appendix, 14.
 चराँट *charānt*, 1147.
 चरी *chari*, 1144, 1183.
 चरुवा *charua*, 83, 316, 467, 713.
 चरुई *charui*, 467, 713.
 चरैया *charaiya*, 1174.
 चरैया *charaila*, 1248.
 चरैया चूल्हा *charaila chulha*, 1248.

- चलन *chala*, 1088.
 चलना बटाम *chalta batām*, 404.
 चलना *chalna*, 39, 325, 440, 606.
 चल्नी *chalni*, 440, 604.
 चल्ल *challal*, 356.
 चल्लल *challalal*, 1113.
 चल्ललब *challalab*, 817, 830, 941,
 949.
 चल्लंकी *challānki*, 519.
 चले *chale*, 478.
 चलोना *chalauna*, 346.
 चलोनी *chalauni*, 56, 331, 346, 439,
 416.
 चलोँसी *chalaunsi*, 894.
 चल्हा *chalha*, 1155.
 चंवर *chamwra*, 1133.
 चसन्दार *chasdār*, 742.
 चश्का *chahka*, 585.
 चश्का *chahta*, 1458.
 चश्क्या *chahbachcha*, 314, 316.
 चश्ल *chahal*, 787.
 चार् *chāin*, 594.
 चाउर *chāūr*, 963, 1365.
 चाऊ *chāu*, 1084.
 चाक *chāk*, 79, 573, 629.
 चाकर *chākar*, 1184.
 चाकल *chākal*, 893.
 चाकी *chāki*, 1014.
 चाकैडा *chākaita*, 1263.
 चांग *chāng*, 49, 895, 970.
 चाँच *chānch*, 799.
 चाँचर *chānchar*, 1154.
 चाँचरी *chānchri*, 318.
 चाँचवाला *chānchwāla*, 1234.
 चाँचवाला घर *chānchwāla ghar*,
 1234.
 चाँची *chānchhi*, 1144.
 चादे *chātai*, 250.
 चाँद *chānr*, 117, 442, 949.
 चाँदा *chānra*, 1259.
 चाँदा *chānda*, 1259.
 चाँदी *chānri*, 24, 1259.
 चाँदु *chāndu*, 1034.
 चातर *chātar*, 382, 646, 1105.
 चाँद *chānd*, 226, 585, 762.
 चाँद चरन्गी *chānd charkhi*, 585.
 चाँदनी *chāndni*, 1178, 1235.
 चादर *chādar*, 585, 730, 740, 745.
 चादर पड़ावेदार *chādar parākedār*,
 585.
 चाँदिल *chāndil*, 816.
 चाँदी *chāndi*, 7.
 चान *chān*, 1088, 1091.
 चाँप *chāmp*, 816.
 चाँपा *chāmpa*, 318, 748.
 चाँपा बखिया *chāmpa bakhiya*, 748.
 चाँपी *chāmpi*, 136, 140.
 चाबुक *chābuk*, 104.
 चाभी *chābhi*, 1250.
 चाभुक *chābhuk*, 99.
 चाम *chām*, 414, 1139.
 चार *chār* 821, 1244.
 चारणार *chārpāi*, 636, 1431.
 चार बास *chār chās*, 821.
 चारा *chāra*, 1144, 1183.
 चारि *chāri*, 1087, 1113.
 चारो *chāro*, 1183.
 चालन *chālan*, 866.
 चालनि *chālani*, 440, 604.
 चालन्वा *chālsa*, 914.
 चाली *chāli*, 179, 233, 327, 429, 750.
 चाल्हा *chālha*, 1155.
 चावल *chāwal*, 963.
 चास *chās*, 801, 817, 818, 819, 821,
 823, 828, 1089, 1192.
 चाहा *chāha*, 419, 527.
 चाहिया *chāhia*, 741 (footnote).
 चिउरी *chiuri*, 1272.
 चिक *chik*, 1141.
 चिकठ *chikath*, 1225, 1227.

- चिकनकौर *chikankaur*, 1146.
 चिकनजिब्हो *chikanjibbho*, 1146.
 चिकना *chikna*, 1045, 1160, 1166.
 चिकनिया *chikaniya*, 1146.
 चिकनी *chikni*, 713, 786, 1183.
 चिकनी मिट्टी *chikni mitti*, 786.
 चिकनी हाँड़ी *chikni hanri*, 713.
 चिकस *chikas*, 1272.
 चिकसा *chiksa*, 1272.
 चिकन *chikkan*, 786, 849n.
 चिकन मिट्टी *chikkan mitti*, 786.
 चिकस *chikkas*, 1272.
 चिखुरनी *chikhurni*, 867.
 चिखुरार *chikhurāi*, 869.
 चिखोर *chichhor*, 1075, 1183.
 चिचिरा *chichira*, 1072.
 चिचुरा *chichura*, 1072.
 चिचोरी *chichori*, 1183.
 चिचोर *chichor*, 1075, 1183.
 चिचोरी *chichori*, 1075.
 चिचोरो *chichoro*, 1183.
 चिड *chit*, 726, 1464.
 चिहुरा *chitura*, 1004, 1031.
 चिहुरा लागल है *chitura lāgal hai*,
 1004.
 चिडा *chittha*, 1464, 1483.
 चिड्डी *chitthi*, 1344, 1464, 1487.
 चितरसेली *chitarseli*, 1073.
 चित्रा *chitra*, 1082, 1089.
 चिता *chita*, 1419, 1422.
 चितावा *chitāwa*, 994.
 चिता सेराएब *chita serāēb*, 1422.
 चितियाएब *chitiyāēb*, 1024.
 चित्ती *chitti*, 1024, 1391.
 चित्ती कौड़ी *chitti kauri*, 1391.
 चिमनार *chinnār*, 1247.
 चिमवा *chinwa*, 1183.
 चिमिया *chiniya*, 1005.
 चिमियाँ *chiniyān*, 1005.
 चिन्ना *chinna*, 991.
 चिन्नी *chinni*, 1014.
 चिपग्या *chipta*, 1037.
 चिपरी *chipri*, 852.
 चिमन्टा *chimta*, 516, 539, 567, 703,
 711, 1033.
 चिमन्टी *chimti*, 516.
 चिरकन्दान *chirakdān*, 702, 1253.
 चिरकुडवा *chirkutwa*, 1456.
 चिरकुडवा पीर *chirkutwa pīr*, 1456.
 चिरचिरा *chirchira*, 1380, 1385.
 चिरचिरी *chirchiri*, 1183.
 चिरना *chirna*, 424.
 चिरमिच्ची *chirmichchi*, 707.
 चिराक *chirāk*, 713.
 चिराग *chirāg*, 713, 1423.
 चिरागदान *chirāgdān*, 702, 711.
 चिराग बत्ती *chirāg batti*, 1423.
 चिरागा *chirāga*, 1441.
 चिरागाह *chirāgāh*, 1147.
 चिरार *chirār*, 1418.
 चिरारी *chirāri*, 1418.
 चिरैया *chiraiya*, 194, 967, 1082,
 1086.
 चिरौगिया *chiraugiya*, 769.
 चिलम *chilam*, 472, 713, 1026, 1034.
 चिलमन्ची *chilamchi*, 699.
 चिलम्वन *chilwan*, 605.
 चिलिफन्ची *chiliphchi*, 699.
 चिलिमन्ची *chilimchi*, 699, 711.
 चिलोपी *chilohi*, 73.
 चिलौज *chijaunj*, 605.
 चिलौद *chilaund*, 605, 646.
 चिलौन *chilaun*, 605.
 चिल्लम *chillam*, 472.
 चिहल *chihal*, 1375.
 चिहल तन *chihal tan*, 1375.
 चिडकार *chihukar*, 1098.
 चीज *chij*, 655.
 चीक *chik*, 1141.
 चीन *chin*, 474, 475, 990, 991, 1084.

- चीना *china*, 991, 1074.
 चीनी *chini*, 312, 1014.
 चीनी के कर्खाना *chini ke karkhāna*, 312.
 चीनी के गोदाम *chini ke godām*, 312.
 चीन्हा *chinh*, 991.
 चीप *chīp*, 184, 427.
 चीर *chīr*, 723.
 चीरा *chīra*, 724, 1265.
 चुआरी *chuāri*, 920c.
 चुक *chuk*, 1084.
 चुकन्की *chukri*, 136, 713.
 चुकन्नी *chukni*, 713.
 चुकल *chukal*, 834.
 चुकिया *chukiya*, 249.
 चुकौचा *chukaua*, 1220.
 चुकड़ *chukkar*, 372, 713.
 चुकर *chukkar*, 713.
 चुका *chukka*, 136, 140, 146, 713.
 चुकी *chukki*, 136.
 चुचुहिया *chuchuhiya*, 1077.
 चुटकी *chutki*, 417, 857, 1201, 1483.
 चुड़िहार *churidār*, 727, 749.
 चुड़िया *churiya*, 561.
 चुड़िहार *churihār*, 561.
 चुड़ेल *churail*, 1458.
 चुन्हा *chunta*, 567.
 चुन्दरी *chundri*, 745.
 चुन्री *chunri*, 745, 1316.
 चुन्वटल *chunwattal*, 1267.
 चुन्हा *chunha*, 659.
 चुनेटल *chunetal*, 1267.
 चुनौती *chunauti*, 659.
 चुन्ना *chunna*, 69, 659, 1267.
 चुन्नी *chunni*, 1272.
 चुभन्की *chubhki*, 570.
 चुभन्ती *chubhti*, 570.
 चुमापन *chumāeb*, 1304.
 चुमावन *chumāwan*, 1279, 1304.
 चुमाणा *chumauna*, 1279, 1304, 1312.
 चुरिया *churiya*, 60, 568.
 चुरिहार *churihār*, 561.
 चुलहोंका *chuljhonka*, 303.
 चुलापन *chulāeb*, 855.
 चुल्हचा *chulhancha*, 303.
 चुल्हानी *chulhāni*, 1248.
 चुल्हिया *chulhiya*, 1248.
 चुसकी *chuski*, 1035.
 चुस *chust*, 727.
 चुसगाव *chuhāb*, 1158.
 चुसड़ *chuhar*, 1456.
 चुसड़ माल *chuhar māl*, 1456.
 चुसाड़ *chuhār*, 1119.
 चुसानी *chuhāni*, 1248.
 चुसणा *chūana*, 1246.
 चुसणा मारव *chūana mārāb*, 1246.
 चुसाँ *chūān*, 578, 920c.
 चुसै *chūān*, 920c.
 चुस *chūe*, 1084.
 चुसा *chūks*, 146.
 चुंटा *chūnta*, 516, 567, 703.
 चुंटी *chūnti*, 516, 539, 567, 1033.
 चुंरा *chūra*, 1272.
 चुड़ी *chūri*, 571.
 चुड़ *chūrh*, 1250.
 चुन *chūn*, 659, 748, 1025, 1267, 1272.
 चुनव *chūnāb*, 1389, 1390.
 चुना *chūna*, 69, 1267.
 चुना फेरल *chūna pheral*, 1267.
 चुन *chūr*, 155, 256, 638, 768, 771, 977, 978, 1037, 1250.
 चुरा *chūra*, 1272.
 चुरी *chūri*, 768, 771.
 चुल *chūl*, 155, 638, 1250.
 चुल *chūlh*, 1247.
 चुल्हा *chūlha*, 312, 301, 435, 454, 1247, 1248, 1306, 1312, 1313, 1377.
 चुल्हा के घर *chūlha ke ghar*, 312.

- चूल्हिक *chūlhik*, 1087.
 चूल्ही *chūlhi*, 1247.
 चूल्हो *chūlho*, 1247.
 चेंगवा चेंगन *chengwa baisingan*, 1073.
 चेपुवा *chepua*, 1012.
 चेपन्ही *chepni*, 738.
 चेपुवा *chepua*, 290.
 चेरुवा *cherua*, 713.
 चेरु *cherui*, 83, 713.
 चेलखी *chelkhi*, 11.
 चेलुवा *chelwa*, 1155.
 चेकी *cheki*, 1251.
 चेंगी *chenghi*, 155.
 चेंच *chench*, 1183.
 चेचक *chechak*, 1175.
 चेंड *chent*, 726.
 चेंडा *cheñra*, 1261.
 चेंदी *chendi*, 165.
 चेनी *cheni*, 165.
 चेन्ही *chenhi*, 165.
 चेपी *chepi*, 1251.
 चेरी *cheri*, 11.
 चेला *chela*, 1261.
 चैत *chait*, 1082, 1084, 1092.
 चैता *chaita*, 809.
 चैती *chaiti*, 1419.
 चेसा *chaisa*, 1261.
 चैली *chaili*, 11, 401, 1261.
 चोकन्नी *chokni*, 452.
 चोकनरा *chokra*, 894.
 चोंगिवा *chongiya*, 416.
 चोरन्नी *chorni*, 1117.
 चोरणा *chorsa*, 403.
 चोरार *chorai*, 1336.
 चोरॉट *chorant*, 1183.
 चोरॉटा *choranta*, 1183.
 चोरावे *chorawai*, 763.
 चोराट *chohat*, 1119.
 चोहैर *chohair*, 1119.
 चोकन *chokan*, 452.
 चोकर *chokar*, 894.
 चोंकर *chonkar*, 894.
 चोका *choka*, 452.
 चोका *chokha*, 800, 1272.
 चोंगा *chonga*, 24, 381, 414, 510, 495.
 चोंगी *chongi*, 414, 510.
 चोट *chot*, 356, 408, 719.
 चोंटी *chonti*, 155, 761.
 चोद *chonrh*, 1117.
 चोंदी *chonrhi*, 1117.
 चोड *chot*, 848.
 चोंबा *chontha*, 1272.
 चोना *chona*, 270.
 चोन्ही *chonhi*, 155.
 चोप *chop*, 124.
 चोंप *chomp*, 124.
 चोपा *chopa*, 1012.
 चोभा *chobha*, 385.
 चोली *chobhi*, 13, 90.
 चोर *chor*, 572, 1178, 1184.
 चोरक *chorak*, 726 (footnote), 1184.
 चोरकिल्ली *chorkilli*, 929.
 चोर मठवा *chor matka*, 1173, 1458.
 चोली *choli*, 744.
 चोहट *chohat*, 1456.
 चौएठा *chauetha*, 828.
 चौकन्ठा *chauktha*, 754, 762.
 चौकन्ठी *chaukthi*, 141.
 चौकन्हा *chaukla*, 629.
 चौकेठा *chauketha*, 828, 857.
 चौगडिवा *chaugathiya*, 828.
 चौगानी *chaugani*, 473e.
 चौगोशिवा *chaugoshiya*, 725.
 चौगोडा *chaugora*, 31, 382.
 चौघडा *chaughara*, 585f.
 चौघॉन *chauganu*, 953.
 चौघावा *chaughawa*, 953.
 चौठारी *chauthari*, 1340.
 चौठेवा *chauthaiya*, 910, 1017, 1053.
 चौत्रा *chautra*, 436, 722, 1243.

चौताना *chautāna*, 585.
 चौधारी *chauthāri*, 1340, 1391.
 चौधेवा *chauthaiya*, 910, 1201.
 चौधरी *chaudhri*, 1452.
 चौपट्टा *chaupatta*, 1075.
 चौपतिवा *chaupatiya*, 1018.
 चौपट्टा *chaupahal*, 403.
 चौपट्टा रेतो *chaupahal reti*, 403.
 चौबगन्धी *chaubaghi*, 828.
 चौबडिया *chaubatiya*, 833.
 चौबडिया *chaubadhiya*, 639.
 चौबरन्दा *chaubarda*, 31, 149.
 चौमन्दी *chaumandi*, 828.
 चौमसिया *chaumasiya*, 1008.
 चौरन्वा *chaurva*, 399, 403, 470, 531, 557.
 चौरन्वी *chaursi*, 557.
 चौरासी *chaurāsi*, 759.
 चौराहा *chaurāha*, 833, 1221.
 चौरैठा *chauretha*, 1272.
 चौहट्टा *chauhatta*, 544.
 चौवा *chauva*, 736, 1094, 1489, 1490, 1495.
 चौक *chauk*, 223, 828.
 चौक *chaunk*, 1347.
 चौकठ *chaukath*, 1250.
 चौक नारन *chauk nāran*, 33.
 चौका *chauka*, 549, 1247, 1426.
 चौकी *chauki*, 30, 35, 36, 389, 457, 629, 635, 765, 830, 1378.
 चौकी *chaunki*, 30, 35.
 चौकी घुमाएव *chauki ghumāev*, 830.
 चौकीदार *chaukidār*, 1200.

चौकीदारी *chaukidāri*, 1200.
 चौकर *chauker*, 828.
 चौकोर *chaukor*, 1260.
 चौकर *chaukhar*, 1097.
 चौकरिया *chaukhariya*, 1097.
 चौकार *chaukhār*, 821.
 चौनेठ *chaugeth*, 828
 चौठ *chauth*, 1091, 1201.
 चौठी *chauthi*, 1088.
 चौंरु *chaunr*, 1117.
 चौथी *chauthi*, 1381, 1391.
 चौथी के जोड़ा *chauthi ke jora*, 1381.
 चौंधा *chaundha*, 646.
 चौधार *chaudhār*, 1260.
 चौपड़ *chaupar*, 833.
 चौपत *chaupat*, 363.
 चौपट्टा *chaupahal*, 1260.
 चौपार *chaupār*, 1245.
 चौंपी *chaunpi*, 713.
 चौभर *chaubhar*, 1095.
 चौमास *chaumās*, 798, 803, 858, 1006.
 चौमांस *chaumāns*, 818.
 चौमांस जोतव *chaumāns jotav*, 818.
 चौमुख *chaumukh*, 833, 1307, 1329, 1374.
 चौर *chaur*, 77.
 चौंर *chaunr*, 784, 790, 920c.
 चौराठ *chaurath*, 1272.
 चौराती *chauratti*, 1499.
 चौरस रेतो *chauras reti*, 403.
 चौरा *chaura*, 748, 775.
 चौरी *chauri*, 1272.

॥ छ *chh* ॥

चक्रवा *chhakra*, 147, 150, 164, 199, 201, 202, 203, 204, 205, 208, 211, 212, 214, 218, 1118.
 चक्रवी *chhakri*, 1118.

चक्रवी *chhakni*, 654.
 चक्रुनी *chhakuni*, 103.
 चक्रु *chhakkar*, 1118.
 चगन्ना *chhagra*, 969.
 चगन्नाएव *chhagrāev*, 1115.

- चगन्ती *chhagri*, 1121.
 चगोटिवा *chhagotiya*, 639.
 चहार *chhachhāi*, 1349.
 चँचिवा *chhanchhiya*, 139.
 चजा *chhaja*, 68.
 चजा *chhajja*, 179.
 चठङ्गी *chhatanki*, 1500.
 चठँक *chhatānk*, 1497, 1498.
 चटिवाप्रव *chhatiydeb*, 1098.
 चहान *chhattan*, 544.
 चड्डी *chhatthi*, 1406.
 चड *chhath*, 1442.
 चड चरन्त *chhath bart*, 1442.
 चडि *chhatthi*, 1406.
 चडिचार *chhatthiyār*, 1406.
 चडो *chhatthi*, 1405, 1406.
 चडङ्गा *chharra*, 771.
 चडा *chhara*, 225.
 चड्डी *chhari*, 585, 654.
 चड्डीदार *chharidār*, 1450.
 चड्डीला *chharila*, 468.
 चत *chhat*, 223, 248, 1244.
 चतन्ना *chhatna*, 45.
 चतन्नी *chhatni*, 245.
 चतन्ती *chhatri*, 213, 223, 245,
 649.
 चतिवा *chhatiya*, 192.
 चत्ता *chhatta*, 1045, 1244.
 चदाँत *chhadānt*, 1118.
 चदाच *chhadām*, 1497.
 चव *chhan*, 768.
 चवन्का *chhanka*, 1272.
 चवन्ना *chhanna*, 853.
 चवान *chhanān*, 713.
 चहुवा *chhanua*, 1130, 1165.
 चहुवा दूव *chhanua dūdh*, 1165.
 चनौटा *chhanauta*, 307, 319^b, 456,
 685, 711.
 चन्द *chhand*, 768.
 चन्ना *channa*, 252, 442.
 चन्दिवा *chhanhiya*, 1244.
 चप *chhap*, 1091.
 चपन्टा *chhapta*, 1074.
 चपरन्वन् *chhaparband*, 1218.
 चपरन्दिवा *chhaprahiya*, 1486.
 चपन्रा *chhapra*, 71.
 चपन्ती *chhapri*, 71, 1244, 1245.
 चपि *chhapi*, 1087.
 चप्पर *chhappar*, 796, 1244.
 चप्पा *chhappa*, 893.
 चपचिवा *chhabadhiya*, 639.
 चमासी *chhamāsi*, 1427.
 चया *chhaya*, 1091.
 चरन्की *chharki*, 99, 111, 832.
 चरन्की बाला *chharki bāla*, 832.
 चरान *chharan*, 1246, 1262.
 चरन्रा *chharra*, 1266.
 चरासी *chharāsi*, 786.
 चरि *chhari*, 573.
 चरिवा *chhariya*, 1244.
 चरन्कडर *chhalkatūi*, 1163.
 चरन्की *chhalki*, 531.
 चरन्चबेला *chhalchhabela*, 1381.
 चरन्ना *chhalna*, 318.
 चरौनी *chhalauni*, 126.
 चहा *chhalla*, 126, 132, 473, 769,
 937, 1366.
 चहावचन्रा *chhallabakhra*, 126.
 चहेदार *chhalledār*, 473.
 चवचड्डी *chhawanni*, 1479.
 चहत्ता *chhahattha*, 737.
 चहत्ती *chhahatthi*, 737.
 चारँ *chhāi*, 1125.
 चाउनि *chhāuni*, 1244.
 चाउर *chhāur*, 849.
 चाप्र *chhāe*, 1088.
 चाकन *chhākan*, 654.
 चाकुन *chhākun*, 103.
 चागर *chhāgar*, 1121.
 चाँच *chhānchh*, 799, 138, 1166.

चाँची *chhānchhi*, 139.
 चाबा *chhāja*, 367.
 चाँडव *chhāntab*, 391, 888.
 चाड़ *chhār*, 356.
 चाड़ा *chhāra*, 1475.
 चाड़ि *chhāri*, 1113.
 चात *chhāt*, 1244, 1250, 1251.
 चाता *chhāta*, 1244.
 चानी के चारी *chhāti ke chāri*, 224.
 चाँद *chhānd*, 105.
 चान *chhān*, 105 (footnote), 110.
 चानन *chhānan*, 801, 918.
 चानी *chhāni*, 853, 1051.
 चान्ह *chhānh*, 1244.
 चान्हो *chhānhī*, 1244.
 चापा *chhāpa*, 534, 569, 871, 1148.
 चावन *chhāvan*, 372, 1246.
 चारन *chhāran*, 1246, 788, 789.
 चारो *chhāro*, 868.
 चाह *chhāl*, 132, 1264.
 चाह के रँदा *chhāl ke rāda*, 1264.
 चाहन्नी *chhālī*, 1264.
 चाही *chhāli*, 1163.
 चाह्नी *chhālhi*, 1163.
 चावन्नी *chhāvni*, 895.
 चावा *chhāva*, 1125.
 चाची *chhāchi*, 71.
 चिचोची *chhiōi*, 1232.
 चिचनिचाँ *chhichaniyān*, 915.
 चिचन्सचिवा *chhichhlahiya*, 788.
 चिटकन *chhitkan*, 103.
 चिटकनी *chhitkani*, 1250.
 चिटकिनी *chhitkini*, 1250.
 चिटकी *chhitki*, 359.
 चिटव *chhitab*, 855.
 चिटार *chhitai*, 1309, 1332.
 चिटि *chhiti*, 23, 99.
 चिट्ठा *chhitua*, 359, 857, 858.
 चिट्टा *chhitua*, 64, 284, 801, 857,
 858.

चिट्टी *chhitti*, 367.
 चितन्ना *chhitna*, 45.
 चितनी *chhitni*, 45.
 चितन्वा *chhinwa*, 943.
 चितुर *chhinui*, 1163.
 चित्तौ *chhinui*, 1163.
 चिपकटा *chhipkatta*, 875.
 चिपनी *chhipni*, 56, 439.
 चिपुची *chhipuchi*, 678.
 चिमन्दी *chhimri*, 994, 1001, 1004.
 चिमोर *chhimoi*, 1183.
 चिरन्ना *chhirkana*, 915.
 चिरन्धिरा *chhirhira*, 284.
 चिरिकनी *chhirikni*, 801.
 चिलकी *chhilki*, 531.
 चिलनी *chhilni*, 593.
 चिलार *chhilai*, 1349.
 चिहा *chhilla*, 1407.
 चिहली *chhili*, 815.
 ची *chhi*, 444.
 चीँडव *chhintab*, 855.
 चीडा *chhita*, 39, 43, 1033.
 चीँडा *chhinta*, 857, 858.
 चीडी *chhiti*, 39, 43, 288.
 चीँड़ी *chhinri*, 1171.
 चीप *chhip*, 414, 931, 1010.
 चीपा *chhipa*, 460, 680.
 चीपी *chhipi*, 1316.
 चीमड़ि *chhimari*, 994, 1004.
 चीमी *chhimi*, 994, 1001, 1004.
 चीरा *chhira*, 1074.
 चीरी *chhiri*, 1074.
 चुषा चन्ना *chhua chhanna*, 853.
 चुषी *chhuchhhi*, 350, 363, 414,
 585a, 763.
 चुष्ठी *chhunchhi*, 363.
 चुहुन्दर *chhuchhundar*, 585f.
 चुटनी *chhutti*, 912, 913, 1192,
 1217, 1230.

- चुठन्ना *chhutha*, 1147.
 चुलन्ना *chhutka*, 1402.
 चुलन्ना के कपड़ा *chhutka ke kapra*,
 1402.
 चू *chhu*, 1451.
 चूच *chhūal*, 1458.
 चूचा *chhūa*, 853.
 चूँची *chhūnchhi*, 414.
 चूट *chhūt*, 912.
 चूटल *chhūtal*, 827, 878.
 चूटल खेत *chhūtal khet*, 827.
 चूटल पटल *chhūtal patal*, 878.
 चूरा *chhūra*, 383.
 चूरी *chhūri*, 388, 470, 474, 583.
 चूसा *chhūsa*, 853.
 चूसी *chhūsi*, 853.
 चूँकनिहार *chheknihar*, 871.
 चूँकवारी *chhenkari*, 1288.
 चूँकवन्ध *chhenkharu*, 1288.
 चूँकार *chhenkārī*, 1335, 1352.
 चूँकीनी *chheñkauni*, 1335.
 चूँजनी *chhejni*, 865, 866.
 चूँरणा *chherua*, 1112, 1121.
 चूँवन्कन *chheukan*, 1272.
 चूँवन्कना *chhewankna*, 1272.
 चूँवन्का *chheuwka*, 1007.
 चूँवन्नी *chheuni*, 576.
 चूँवन्नी *chheuno*, 576.
 चूँवणा *chheua*, 1022.
 चूँकन *chhekan*, 323.
 चूँका *chhenka*, 1287, 1288.
 चूँजल *chhejal*, 865.
 चूँकी *chhenri*, 1074, 1173.
 चूँद *chhed*, 156, 604.
 चूँना *chhena*, 1163, 1272.
 चूँना बाड़ा *chhena bāra*, 1272.
 चूँनी *chheni*, 284, 413, 521, 557,
 560, 624.
 चूँनी *chhemi*, 994, 996, 1001.
 चेर *chher*, 954, 1121.
 चेरी *chheri*, 1116, 1121.
 चेषन *chhevan*, 576.
 चेषन *chhewab*, 379.
 चेषर *chhehar*, 858.
 चैँटा *chainta*, 44, 318.
 चैँटी *chhainti*, 43, 288, 369.
 चोठन्की *chhotki*, 1276.
 चोषन्नी *chhopni*, 97, 1024.
 चोरन्ना *chhorna*, 1010.
 चोरौन्ना *chhorauna*, 1250.
 चोखन्नी *chholni*, 319h, 456, 555.
 चोखन्ना *chholwa*, 292.
 चोषा *chhoa*, 1014.
 चोट *chhot*, 1217.
 चोट खोर *chhot log*, 1217.
 चोडि *chhoti*, 566.
 चोडि चकुरी *chhoti akuri*, 566.
 चोडि चेषवारी *chhoti bedhwari*, 566.
 चोँद *chhonr*, 83, 505.
 चोँद *chhonrh*, 83, 696, 713.
 चोँदी *chhorhi*, 144.
 चोँदी *chhorhi*, 713.
 चोनी *chhoni*, 270.
 चोपा *chhopa*, 48.
 चोपी *chhopi*, 48.
 चोर *chhor*, 116, 930.
 चोरी *chhori*, 115, 116, 930, 1457.
 चोखल *chholal*, 873.
 चोनिहार *chhaunihar*, 1244.
 चौ *chhau*, 1084.
 चौँकल *chhaunkal*, 1272.
 चौँका *chhaunka*, 1272.
 चौँकी *chhaunki*, 963, 1272.
 चौँना *chhauna*, 1125.
 चौँनी *chhauni*, 576, 1128, 1244,
 1245, 1246.
 चौँराट *chhaurāth*, 849.
 चौँरो *chhauro*, 849.

॥ ज j ॥

- जरे *jai*, 758, 768, 961, 962.
 जकेरार *jakerāi*, 959, 1183.
 जखार *jakhār*, 775.
 जन *jag*, 1459.
 जगन्धोरी *jagdori*, 33.
 जगत *jagat*, 939.
 जगन्धमा *jagdamma*, 1175, 1456.
 जगन्निधिवा *jaarnathiya*, 972.
 जंगला *jangla*, 939, 1075.
 जंगली बावग *jangli bāwag*, 858.
 जगन्वरिया *jagwariya*, 870.
 जगन्वारी *jagwāri*, 870.
 जगह *jagah*, 1234.
 जंघिया *janghiya*, 464, 609, 727, 1328.
 जंघिया बेसाप्रब *janghiya baisādeb*, 1328.
 जङ्गल *jangal*, 813.
 जङ्गी *jangi*, 585d.
 जङ्गी बान *jangi bān*, 585d.
 जङ्गा *jangha*, 252, 431, 464, 605, 609.
 जखन्वेचा *jachwāya*, 1484.
 जखा *jachcha*, 1398.
 जखा खाना *jachcha khāna*, 1398.
 जजाती *ajāti*, 913.
 जजाती बटार *ajāti batāi*, 913.
 जतहा *jataha*, 1111.
 जठ्ठावा *jathāwa*, 1111.
 जटा मसी *jata masi*, 468.
 जटो *jato*, 1111.
 जठ्ठन *jathhan*, 805.
 जड़ *jar*, 362a, 1010.
 जड़ खर *jar khar*, 1010.
 जड़बन्धना *jarbandhna*, 119.
 जड़िया *jariya*, 1010.
 जड़ी *jari*, 1010.
 जंतकुटा *jantkutta*, 624.
 जंतवा *jantwa*, 619.
 जतरी *jatri*, 517.
 जददी *jaddi*, 1215.
 जदो *jaddi*, 1214.
 जन *jan*, 293, 842, 844, 874, 990, 1184.
 जनजीर *janjir*, 198.
 जनजीरा *janjira*, 590.
 जनपेचा *janpaincha*, 846.
 जनम गेंठ *janam genth*, 1331.
 जनम गेंठि *janam genthi*, 1357.
 जनम पतर *janam patr*, 1343.
 जनम पतरी *janam patri*, 1343.
 जनमासा *janmāsa*, 1320.
 जनवांसा *janwānsa*, 1320, 1322, 1326, 1327, 1337, 1338, 1339.
 जानाजा *janāja*, 1431.
 जानाना *janāna*, 1254, 1275.
 जानाना किता *janāna kita*, 1254.
 जानानी धोती *janāni dhoti*, 740.
 जानि *jani*, 1088.
 जानिका *janika*, 235 (footnote), 394, 604.
 जानिहन *janiha*, 1084.
 जानु *janu*, 1113.
 जानेव *janeva*, 736.
 जानेव *janeu*, 736.
 जानेर *janer*, 985.
 जानेरा *janera*, 983, 985, 1144.
 जानेव *janev*, 736.
 जानौर *janaur*, 1186.
 जान्त *jant*, 169, 221.
 जानारी *jantari*, 961.
 जान्नी *janni*, 1275.
 जान्नी *jantri*, 386, 517.
 जपन्त *japti*, 1231.
 जब *jab*, 959, 961, 990, 1084, 1113.
 जब केरवा *jab kerwa*, 959.
 जबदोरी *jabdi*, 1231.
 जब बुट्टा *jab butta*, 959.
 जबरा *jabra*, 77, 85.

- जमकाठ *jamkāth*, 925.
 जमरिया *jamariya*, 956.
 जमवट *jamvat*, 925.
 जमा *jama*, 1463a, 1468, 1472.
 जमाखरख *jamakharch*, 1463d,
 1468c, 1472; Appendix, 16.
 जमाबन्दी *jamābandī*, 1468c, 1472;
 Appendix, 15.
 जमानार *jamāmār*, 1477.
 जमार *jamār*, 1075.
 जमार गढ़ार *jamār garār*, 1075.
 जमाख *jamāl*, 1045.
 जमाख खानी *jamāl khāni*, 956.
 जमाख गोटा *jamāl gota*, 1045.
 जमाखी *jamāli*, 956.
 जमाव *jamāo*, 1163.
 जमाव दही *jamāo dahi*, 1163.
 जमा वासिल खानी *jama wāsil khāni*,
 1468c, 1472.
 जमिंदार *jamidār*, 904.
 जमुर् *jamuī*, 1163.
 जमुरा *jomūra*, 404, 411, 517, 385.
 जमुरी *jamuri*, 517.
 जमोट *jamot*, 925.
 जमौवा *jamaua*, 639.
 जम्बूर *jambur*, 388.
 जम्हार *jamhār*, 1075.
 जम्हूरा *jamhūra*, 404, 411.
 जर *jar*, 1010, 1201, 1210.
 जरई *jarai*, 862, 982.
 जरकटा *jarkatta*, 875.
 जरखा *jarkha*, 339.
 जरखोर *jarkhor*, 1180.
 जर चौड *jar chauth*, 1201.
 जरखोरनी *jarchhorni*, 875.
 जरखोरा *jarchhora*, 875.
 जरठुवा *jarathua*, 1043.
 जरठुवा तेल *jarathua tel*, 1043.
 जरदोज *jarđoj*, 502.
 जर पेन्गी ठीका *jarpešgi thika*, 1210.
 जरराख *jarrāh*, 384.
 जर समन *jar saman*, 1210.
 जरसुधा *jarsudha*, 238.
 जरायब *jarāyb*, 1416.
 जराख *jarāh*, 384.
 जरि *jari*, 115 (footnote), 444.
 जरिया *jariya*, 370, 1008.
 जरिया के ख *jariya ke kh*, 1008.
 जरी *jari*, 798, 1006.
 जरी खेत *jari khet*, 798.
 जरवा *jarua*, 1043.
 जरवा तेल *jarua tel*, 1043.
 जरवा सोरा *jarua sora*, 370.
 जरेँ *jareñ*, 1166.
 जल *jal*, 655, 1091, 1451.
 जलकर *jalkar*, 1232.
 जलकी *jalki*, 789.
 जलखरी *jalkhai*, 1268.
 जलखर *jalkhar*, 1145.
 जलखरी *jalkhari*, 41, 650.
 जलखवावा *jalkhāwa*, 1268.
 जलखेराव *jalgherāv*, 1268.
 जलखर *jaldhar*, 923.
 जलखरी *jaldhari*, 697.
 जलपरवाव *jalparwāh*, 1428.
 जलपातर *jalpātar*, 775.
 जलपान *jalpān*, 1268.
 जलमंहार *jalamhār*, 233.
 जलवा *jalwa*, 1380, 1384, 1385.
 जलवा देव *jahwa deb*, 1385.
 जलवेया *jahwaiya*, 1458.
 जलखोर *jalthor*, 973.
 जलखा *jalāka*, 939.
 जलसेन *jalāsen*, 1456.
 जलिया *jaliya*, 87.
 जलेबी *jalebi*, 585.
 जलोतखरग *jalotsarg*, 1459.
 जला *jalla*, 647, 650, 1092, 1145.
 जलसधा *jawsadhā*, 238.
 जवा *jawa*, 748, 765.

- जवारन *jawāin*, 1073.
 जवाहार *jawākhār*, 1272.
 जवा गोटा *java gota*, 765.
 जवाघ *javāy*, 1274.
 जवारा *javāra*, 961.
 जवारी *javāri*, 758.
 जवास *javās*, 1085.
 जसरिया *jasariya*, 965*f*.
 जसेर *jaser*, 940.
 जसोधा *jasodha*, 238.
 जसड़ *jahar*, 938.
 जहरग्नात *jaharbāt*, 1179.
 जहरग्नाद *jaharbād*, 1179.
 जहेज *jahej*, 1283.
 जारही *jāchhi*, 625.
 जारठ *jāth*, 346.
 जारल *jāil*, 860, 1132.
 जारै *jāi*, 833, 1092.
 जाउर *jāur*, 1272.
 जाए *jāē*, 1087, 1088.
 जाएब *jāēb*, 1078, 1132, 1173, 1174,
 1486.
 जाओ *jāo*, 1087.
 जाक *jāk*, 893.
 जाकड़ *jākar*, 1480.
 जाकर *jākar*, 1462.
 जागर *jāgar*, 965*b*.
 जागौर *jāgīr*, 1200, 1209*b*.
 जागौरन्दार *jāgīrdār*, 1200.
 जाने *jāge*, 1026.
 जाँघा *jāngha*, 609, 1328.
 जाँघा बैसाएब *jāngha baisāēb*, 1328.
 जाँच *jānch*, 1485.
 जाँचब *jānchab*, 1484.
 जाँच मिलान *jānch milān*, 1485.
 जाँच लेब *jānch leb*, 1485.
 जाजिम *jājim*, 750.
 जाट *jāt*, 917.
 जाटि *jāti*, 917.
 जाठ *jāth*, 256, 273, 346, 917.
 जाठि *jāthi*, 330, 917.
 जाड़ *jār*, 1092.
 जाड़ा *jāra*, 1083.
 जात *jāt*, 1089.
 जाँत *jānt*, 443, 625, 928.
 जाँता *jānta*, 443, 581, 619.
 जाति *jāti*, 1217.
 जादू *jādu*, 1453.
 जादूबर *jādūgar*, 1453.
 जान *jān*, 719, 790.
 जानधि *jānathi*, 356.
 जाना *jāna*, 915, 844.
 जानिमाज *jānimāj*, 751.
 जानिहार *jānihār*, 1416.
 जाप माला *jāp māla*, 781.
 जाफरी *jāphri*, 770.
 जाब *jāb*, 94.
 जाबना *jābta*, 1474.
 जाबना साब जोग *jābta sāb jog*, 1474.
 जाबर *jābar*, 1272.
 जाबा *jāba*, 94.
 जाबी *jābi*, 94.
 जाम *jām*, 678.
 जामा *jāma*, 732, 1371, 1379, 1381,
 1382.
 जामुन *jāmun*, 1272.
 जाम्हर *jāmhar*, 1075.
 जाय *jāe*, 250, 356, 414, 572, 604,
 1084, 1272.
 जाय नेमाज *jāy nemāj*, 751.
 जारब *jārab*, 1416.
 जाल *jāl*, 646, 1094.
 जालन्दार *jāldār*, 1236.
 जाला *jāla*, 69, 224, 647, 713, 1074,
 1145.
 जाली *jāli*, 87, 94, 646, 650, 748.
 जालीदार *jālidār*, 1236.
 जावर *jāwar*, 1400.
 जाँवर *jāūwar*, 1400.
 जावा *jāwa*, 758, 987.

- जासर *jāsar*, 1037.
 जासु *jāsu*, 1033.
 जाह *jah*, 790, 1142.
 जिउतिवा *jiutiya*, 1447.
 जिहरी *jikri*, 1487.
 जिगरी *jigri*, 1487.
 जिग्गा *jigga*, 757, 768.
 जितिवा *jitiya*, 1447.
 जिन *jin*, 1458.
 जिन्दगी *jinwān*, 1075, 1183.
 जिनिच *jinis*, 1470a.
 जिनिसवार *jiniswār*, 1468a.
 जिबोरा *jinora*, 983, 985, 987.
 जिन्दार *jinḥār*, 1075.
 जिब दान *jibḍān*, 1457.
 जिमिया *jibiya*, 275.
 जिभा *jibbha*, 711.
 जिभी *jibbi*, 1173.
 जिभसत्ता *jibhsatta*, 1173.
 जिभिया *jibhiya*, 275.
 जिहेला *jihela*, 363.
 जिमिदार *jimidār*, 1208.
 जिमिदारी *jimidāri*, 1207.
 जियता *jiyata*, 640.
 जिवा *jiya*, 1457.
 जिवा दान *jiya dān*, 1457.
 जिरतिवा *jiṛatiha*, 1184.
 जिरात *jiṛāt*, 903, 1040, 1221.
 जिलदगर *jildgar*, 586.
 जिलदगबन्ध *jildband*, 586.
 जिलचैया *jilchāiya*, 1458.
 जिलचैया के छूचल *jilchāiya ke chhūal*,
 1458.
 जिजा *jila*, 589, 1040.
 जिलादार *jilādār*, 1040.
 जिजा दान *jilā dān*, 589.
 जिलेबवा *jilebiya*, 473.
 जिलबिया कुलफी *jilebiya kulphi*, 473.
 जिलेबी *jilebi*, 1272.
 जिलैया *jilaiya*, 1458.
 जिवग्गर *jiwgar*, 851, 922.
 जिवग्गर पानी चाबि गेल *jiwgar pāni*
ābi gel, 922.
 जिवग्गर चोपडा दूर बेलाचोल *jiwgar*
hoē la dhūr baisāol, 851.
 जिवा *jista*, 335h, 706.
 जिवग्गा *jihla*, 363.
 जिहेला *jihela*, 363.
 जीए *jie*, 1026.
 जीगर *jigar*, 800.
 जीता *jita*, 645.
 जीभा *jibha*, 275.
 जीबत *jiyat*, 645.
 जीबल *jiyal*, 933.
 जीर *jir*, 972, 1073.
 जीरा *jira*, 975, 1073.
 जुवाठ *juāth*, 14, 194, 938.
 जुग *jug*, 1023.
 जुग्गा *jugra*, 1183.
 जुगनु *jugnu*, 765.
 जुजुगी *jujwi*, 1208.
 जुजुगी बिसुँदार *jujwi hissedār*,
 1208.
 जुग्गुगु *juguro*, 1183.
 जुइली *jurailin*, 1310.
 जुइल *jurailu*, 1310.
 जुता *jutta*, 735.
 जुनेरी *juneri*, 121, 122.
 जुना *junna*, 120.
 जुबल *jūar*, 193, 938.
 जुवा *jūa*, 14, 194, 443, 621, 1391.
 जुग *jūg*, 1483.
 जुड़ *jūr*, 1449.
 जुड़ चीतल *jūr stāl*, 1449.
 जुड़ सितलक विपाही *jūr sillak sipāhi*,
 1449.
 जुता *jūta*, 735.
 जुता गोर लगर *jūta gor lagāi*,
 1336.
 जुता चोरार *jūta chorāi*, 1336.

जूना *jūti*, 735.
 जूना *jāna*, 96, 120, 122.
 जूर *jūr*, 1183.
 जूही *jūhi*, 585.
 जेकरा *jekra*, 1020.
 जेठन्स *jethans*, 1214.
 जेठकी *jethki*, 1276.
 जेठरी *jethri*, 1276.
 जेठरीयत *jeth raiyat*, 1217.
 जेठन्स *jethhans*, 1214.
 जेठुचा *jethua*, 879, 1021, 1228.
 जेठौठी *jethauti*, 1214.
 जेठौती *jethauti*, 1214.
 जेठनार *jeonār*, 1345, 1426.
 जेवारन *jewāin*, 1073.
 जेवारिन *jevāin*, 1402.
 जे *je*, 967, 1025, 1085, 1087, 1091,
 1092.
 जेकर *jekar*, 1086.
 जेठ *jeth*, 1082, 1092.
 जेठी *jethi*, 985.
 जेड़ *jer*, 1124.
 जेब *jeb*, 77.
 जेरपार *jerpāi*, 735.
 जेरबन्स *jerband*, 226.
 जेह *jel*, 1124.
 जेव *jemo*, 966.
 जेवर *jemoar*, 115, 398, 415.
 जेष्ठा *jeshta*, 1082.
 जेदादी *jaidādi*, 1224.
 जे *jai*, 962.
 जैती *jainti*, 961.
 जैतुक *jaituk*, 1283.
 जैत्री *jaintri*, 517.
 जैबों *jaibon*, 1087.
 जैयद *jaiyād*, 800.
 जैवा भिरन्चा *jaiya mircha*, 1073.
 जोकन्डी *jokti*, 1171.
 जोगनियॉ *joganiyān*, 870.
 जोगाप्रब *jogāeb*, 870.

जोडाप्रब *jorāeb*, 1404.
 जोतिहठ *jotiha*, 829.
 जोधरिया *jondhariya*, 987.
 जोधरी *jondhri*, 985.
 जोन्हरी *jonhri*, 985.
 जोन्हिवा *jonhiya*, 155.
 जोरन्वा *jorwa*, 378.
 जोरन्चा *jolha*, 355, 356, 990.
 जोसगिनी *jolhini*, 856.
 जोलाचा *jolāha*, 355, 356.
 जोसांदा *josānda*, 963.
 जो *jo*, 959, 961.
 जोँ *jon*, 1084, 1087, 1090.
 जोँका *jonka*, 13, 233, 1011.
 जोँकी *jonki*, 13, 1171.
 जो खेररा *jo kheera*, 959.
 जोग *jog*, 1343, 1474, 1457, 1487.
 जोग टोन *jog ton*, 1457.
 जोग मिलब *jog milab*, 1343.
 जोग मिलाप्रब *jog milāeb*, 1343.
 जोंगा *jonga*, 967e, 970.
 जोगी *jogi*, 782, 1092.
 जोठ *joth*, 938.
 जोड़ *zor*, 1331.
 जोड़ा *jora*, 625, 735, 1096, 1381.
 जोड़ी *jori*, 149, 451, 941, 1096.
 जोही *zorhi*, 1129.
 जोत *jot*, 226, 825, 828, 1009.
 जोतब *jotab*, 817, 818, 1098.
 जोतल *jotal*, 817, 1098.
 जोता *jōta*, 18, 116, 196, 642, 818,
 930.
 जोता बावग *jota bāwag*, 818.
 जोती *jōti*, 18, 120, 145, 196, 116,
 117, 398, 415, 470, 642, 645, 930.
 जोन्ही *jonhi*, 155.
 जोब *job*, 1183.
 जो बुहा *jo butta*, 959.
 जोर *zor*, 108, 110, 115, 1088.
 जोरन *zoran*, 1162.

जोरा *jora*, 128, 1145.
 जोरु *joru*, 1275.
 जोरो *joro*, 110.
 जोरा *joha*, 270.
 जोरुनी बरन्ज *jaurhi barm*, 1456.
 जो *jau*, 356, 444, 959, 960, 961,
 1000, 1089, 1504.
 जो *jañ*, 1084, 1087, 1088.
 जो केरार *jau kerāi*, 959, 960, 1000,
 1183.

जोगा *jauga*, 969.
 जोजी *jauji*, 1275.
 जोहा *jaunrha*, 184.
 जो मदरा *jau matra*, 959.
 जोरा *jaura*, 1194, 1204.
 जोरी *jauri*, 115, 120.
 जोसन *jausan*, 767.
 जो *jiyon*, 568, 737.

॥ अ ज ॥

अकना *jhakna*, 84.
 अकाप्र *jhakāēb*, 876.
 अखुरी *jhakhuri*, 815.
 अखुली *jhakhuli*, 815.
 अगार *jhaggār*, 935.
 अङ्गा *jhanga*, 896.
 अज्जर *jhajjar*, 713.
 अज्जरा *ghanjhara*, 307, 319b, 456,
 685.
 अज्जिया *ghanjiya*, 835.
 अठका *jhataka*, 184, 190, 191, 205,
 224.
 अठनी *jhantni*, 887.
 अठथा *jhatha*, 41.
 अठाह *jhatahab*, 876.
 अठथा *jhathua*, 894.
 अठै *jhatai*, 55.
 अठनी *jhataini*, 57.
 अठुथा *jhathua*, 53.
 अनाक *ghanak*, 1174.
 अनाकठ *ghanakat*, 1251.
 अनाकवाता *ghanakbāta*, 1174.
 अनाकवाह *ghanakwāh*, 1174.
 अनाका *ghanaka*, 1174.
 अनाकौट *ghanakaut*, 1250.
 अनाप *ghanapat*, 655.
 अनापना *ghanapna*, 79, 562.
 अनापान *ghanapān*, 957.

अज्जिया *ghampiya*, 45.
 अज्जरा *ghabra*, 1110.
 अज्जरी *ghabhi*, 136, 713.
 अज्जिया *ghabiya*, 767, 770.
 अज्जा *ghabba*, 770.
 अज्जु *ghabbu*, 100.
 अज्जरी *ghamri*, 995.
 अज्ज *ghar*, 878, 980, 1075.
 अज्जकटी *gharkanti*, 815.
 अज्जका *gharka*, 679, 1074.
 अज्जकाप्र *gharkhāēb*, 876.
 अज्जगा *ghanrga*, 967f.
 अज्जगा *gharnga*, 878, 1075.
 अज्जगराप्र *gharjharāēl*, 876.
 अज्जना *gharna*, 57, 401, 440, 456,
 606, 685, 711.
 अज्जना रन्दा *gharna randa*, 401.
 अज्जनी *gharni*, 428, 747.
 अज्जहा *gharha*, 815.
 अज्जरी *ghari*, 1088.
 अज्जथा *gharua*, 878, 1183.
 अज्जमरन्दन *ghalmardan*, 965d.
 अज्जरिया *ghalariya*, 985.
 अज्जली *ghalsi*, 121.
 अज्जल *ghalās*, 121, 815, 1481.
 अज्जक *ghankab*, 1405.
 अज्जकी *ghankhi*, 57.
 अज्जंग *ghāng*, 896, 995.

झोंक *jhānjh*, 685, 776.
 झोंका *jhānjha*, 1272.
 झोंकर *jhāntab*, 887.
 झोंटा *jhānta*, 57.
 झोंटी *jhānti*, 815.
 झारु झरु *jhār jhūr*, 1446.
 झारुनी *jhārni*, 866.
 झारुचा *jhāruca*, 53.
 झारु *jhāru*, 53, 57, 465.
 झॉप *jhāmp*, 45, 50, 467, 554.
 झॉपन *jhāmpān*, 554.
 झॉपन्वा *jhāmpna*, 554.
 झॉपा *jhāmpa*, 45.
 झॉपी *jhāmpi*, 45, 657.
 झाबर *jhābar*, 1110.
 जाम *jhām*, 27, 602, 1264.
 जामा *jhāma*, 27, 591, 1264.
 जामो *jhāmo*, 1264.
 जार *jhār*, 815, 655, 995, 1075,
 1183, 1250.
 जारंग *jhārang*, 878.
 जारङ्ग *jhārang*, 1075.
 जारन *jhāran*, 980.
 जारब *jhārab*, 58, 887.
 जारा *jhāra*, 815.
 जारि *jhāri*, 58.
 जारि झुरि देब *jhāri jhuri deb*, 58.
 जारी *jhāri*, 432, 688, 689, 713.
 जारी के रन्दा *jhāri ke randa*, 402.
 जारु *jhāru*, 56.
 जारु *jhāru*, 439.
 जाल *jhāl*, 776.
 जालार *jhālar*, 590.
 जाला *jhāla*, 1024.
 जावन *jhāwan*, 1477.
 जाँवा *jhāwān*, 1264.
 झिकन्डा *jhikta*, 793.
 झिकन्डिया *jhiktiya*, 793.
 झिकन्डी *jhikti*, 793, 794, 1262.
 झिकन्डौर *jhiktaur*, 793.

झिकन्दा *jhikra*, 793.
 झिकन्डी *jhikri*, 1262.
 झिकन्डौर *jhikraur*, 793.
 झिंयुनी *jhinguni*, 1069.
 झिंयुली *jhinguli*, 1069.
 झिङ्गा *jhinga*, 1069.
 झिटकी *jhituki*, 1262.
 झिडी *jhitti*, 99, 149, 196, 1096.
 झिमन्की *zhimki*, 742, 745.
 झिमन्किमिया *zhimjhimiya*, 764.
 झिरन्वा *zhirwa*, 1075.
 झिरवा *zhirua*, 1075.
 झिरौवा *zhiraua*, 1075.
 झिलिया *zhiliya*, 1272.
 झिली *zhilli*, 1074, 1272.
 झोंक *zhīnk*, 622.
 झोंका *zhīka*, 622.
 झोंका *zhīnka*, 622.
 झीरो *zhīro*, 1075, 1183.
 झील *zhīl*, 790.
 झुकन्ता *zhukta*, 645.
 झुटका *zhutka*, 1262.
 झुटकी *zhutki*, 1262.
 झुण्ड *jhund*, 1124.
 झुगन्की बीर *jhunki bir*, 1456.
 झुमक *jhummak*, 764.
 झुरन्गी *jhurni*, 866.
 झुरि *jhuri*, 58.
 झुलन्गी *jhulni*, 763.
 झूड़ *jhūr*, 1446.
 झूड़ *jhūnr*, 1124.
 झूमक *jhūmak*, 764.
 झूर *jhūr*, 815.
 झूल *jhūl*, 133, 1431.
 झूला *jhūla*, 744.
 झूस *jhūs*, 799.
 झूसी *jhūsi*, 799.
 झेंगन्डा *jhagta*, 896.
 झेंगन्दा *jhengra* 937.
 झेंगन्दा *jhengra*, 896, 995.

जेंगी *jhengi*, 973.
 जोंकरा *jhonkral*, 1080.
 जोंप्रा *jhomptra*, 879, 1234.
 जोंप्री *jhonpri*, 71, 879, 1234.
 जोहार *jhohāil*, 1080.
 जोंक *jhonk*, 196.
 जोंहन *jhonjhan*, 1258.

जोर *jhor*, 789, 882, 1001, 1272.
 जोरा *jhoral*, 876.
 जोरा *jhora*, 41, 734, 781, 647, 832.
 जोरी *jhori*, 507, 647.
 जोल *jhol*, 1116.
 जोला *jhola*, 41, 133, 134, 647, 1080.
 जोली *jholi*, 133, 134, 647.

॥ ट ङ ॥

टकना *takna*, 482.
 टकसा *taksāl*, 1488.
 टकही *takhi*, 1198, 1479.
 टका *taka*, 1479, 1497.
 टकूचा *takua*, 350, 499, 518.
 टकौरी *takauri*, 462, 640.
 टका *takka*, 1500.
 टंगना *tangna*, 649.
 टंगनी *tangni*, 364, 613, 649.
 टंगव *tangbah*, 363.
 टंगारी *tangāri*, 86.
 टंगारी *tangāri*, 395.
 टंगुनी *tanguni*, 988.
 टंगौर *tangaur*, 49, 895.
 टंगा *tanga*, 395.
 टटगर *tatghar*, 1234.
 टटुचानी *tatuāni*, 1126.
 टटौघर *tataughar*, 1235.
 टटो *tatti*, 381, 585, 1051,
 1250.
 टटो लीघर *tatti līlu phar*, 585.
 टटू *tattu*, 1126.
 टंरना *tanrna*, 276
 टंरुचा *tanrua*, 792, 954.
 टपका *tapka*, 1246.
 टपका मार *tapka mārāb*, 1246.
 टप्पर *tappar*, 319m.
 टरवा *tarvāh*, 857.
 टरसूरी *tarsūi*, 24.
 टरिया *tariya*, 713, 767.

टलना *talna*, 161.
 टला *talāh*, 161.
 टलुचा *talua*, 161.
 टहरा *tahra*, 1125.
 टहरी *tahri*, 136.
 टांक *tānk*, 372.
 टाकर *takar*, 793.
 टाका *tāka*, 1113.
 टांग *tāngab*, 624, 1422.
 टांग *tāngah*, 363.
 टांगा *tānga*, 224, 395.
 टांगी *tāngi*, 395.
 टांगुन *tāngun*, 988.
 टाट *tāt*, 129, 319, 1051, 1486.
 टाटी *tāti*, 1051, 1084, 1234, 1250,
 1416.
 टांठी *tānhi*, 682.
 टार *tār*, 713, 784.
 टार *tānr*, 784, 788, 790, 857.
 टारा *tāra*, 713, 1011, 1074.
 टारु *tānra*, 1074.
 टारी *tāri*, 713.
 टारी *tānri*, 24, 328, 784, 1074.
 टाप *tāp*, 48, 50, 646.
 टापा *tāpa*, 48, 50.
 टापी *tāpi*, 48, 50, 646.
 टार *tār*, 24, 767, 857.
 टार *tānr*, 857.
 टार *tārāb*, 857.
 टारी *tāri*, 857.

टास *tal*, 161, 784, 858, 890, 894,
 986.
 टासी *tāsi*, 1263.
 टिकन्डी *tikthi*, 318, 1418.
 टिकन्डी के लकरी *tikthi ke lakri*,
 226.
 टिकरी *tukri*, 466, 1272.
 टिकिया *tikiya*, 1272.
 टिकुला *tikula*, 1272.
 टिकुली *tikuli*, 747, 762.
 टिकोड़ा *tikorha*, 1272, 1449.
 टिकोर *tikor*, 793.
 टिकार *tikkar*, 791, 793.
 टिकन्डी *tikhthi*, 567.
 टिपन्कारि *tipkari*, 1246.
 टिपन्दार *tipdār*, 1208, 1217.
 टिपन्ना *tipna*, 480.
 टिपन्नी *tipni*, 867.
 टिपुनी *tipuni*, 482.
 टिबो *tibbi*, 1009.
 टिभिचा *tibhiya*, 987.
 टिररी *tirri*, 1074.
 टिल्हा *tilha*, 791, 793.
 टिल्हा टाकर *tilha takar*, 793.
 टीक *tik*, 69.
 टीकच *tikach*, 240.
 टीका *tika*, 1400.
 टीरो *tiri*, 1074.
 टीनी *tini*, 1183.
 टीपन *tipan*, 1343.
 टीपुर *tipur*, 793.
 तुईया *tufiya*, 713.
 तुकरी *tukri*, 1272.
 तुंगना *tungna*, 958.
 तुंगनी *tungni*, 875.
 तुटाच *tutach*, 1094.
 तुङ्की *tunki*, 1074, 1177.
 तुडाँ *tuḍān*, 713.
 तुई *tūin*, 713.
 तुक *tūk*, 723.

तुका *tūka*, 1272.
 तुंगव *tungab*, 624.
 तुट *tūt*, 922, 1094.
 तुट गैल *tūt gail*, 1094.
 तुटन *tūtan*, 1265.
 तुंर *tūr*, 958, 961.
 तुंरा *tūra*, 961, 958.
 तुसल *tusal*, 604.
 टेकन्डी *tekthi*, 318.
 टेकनी *tekni*, 464.
 टेकानी *tekani*, 167, 169, 173, 174,
 175, 176, 179, 182, 184, 189,
 200, 203, 221, 222, 464.
 टेकुचा *tekua*, 350, 499, 518, 589.
 टेकुरी *tekuri*, 518.
 टेकुली *tekuli*, 518.
 टेकौरी *thekauri*, 462.
 टेकन्तो *tekhti*, 461, 508.
 टेकन्धी *tekhi*, 226.
 टेहुचा *tehrua*, 243.
 टेपन्डा *tepta*, 842, 1097.
 टेपा *tepai*, 319j.
 टेरुचा *terua*, 243, 1252, 1256, 1257.
 टेहरा *tehra*, 713.
 टेहरी *tehri*, 136.
 टेहान *tehan*, 1120.
 टेन्ट *tent*, 728.
 टेनी *teni*, 1011.
 टेम्बी *tembhi*, 957.
 टेमा *tema*, 96.
 टेर *ter*, 1017, 1110, 1113.
 टोकन्दा *tokra*, 44.
 टोकन्डी *tokri*, 44, 49, 369, 895.
 टोकन्दार *tokdār*, 1040.
 टोकन्ना *tokna*, 669.
 टोकन्नी *tokni*, 97, 261, 867.
 टोटका *totka*, 69, 1457.
 टोटन्ना *totma*, 69, 1457.
 टोटन्स *totram*, 1457.
 टोटन्वाँ *totwān*, 69.

टोंडिया *tontiya*, 713.
 टोंडियारी *tontiyāri*, 1262.
 टोडिया *toriya*, 1265.
 टोमकट *tonkat*, 286.
 टोमकहा *tonkatta*, 286, 293.
 टोमकाह *tonkhād*, 281, 298, 1008.
 टोमकावा *tonkhāwa*, 1008.
 टोनिकाहा *tonikatta*, 293.
 टोनियाठी *toniyāthi*, 281.
 टोनियारी *toniyāri*, 281, 298.
 टोनियासी *toniyāsi*, 281, 298.
 टोपना *topna*, 413.
 टोपरा *topra*, 832, 838.
 टोपरी *topri*, 832.
 टोरगाह *torwāh*, 857.
 टोरवा *toiy*, 1246.
 टोक *tok*, 1040.
 टोकब *tokab*, 866, 867.

टोंडा *tonta*, 1010.
 टोंडी *tonti*, 688, 1262.
 टोड़ *tor*, 918.
 टोंड़ *tonr*, 857.
 टोड़ा *tora*, 768.
 टोन *ton*, 1457.
 टोना *tona*, 69, 933, 940, 1008,
 1457.
 टोनी *toni*, 288, 1008.
 टोपड़ *topar*, 895.
 टोपन *topan*, 413.
 टोपी *topi*, 398, 725.
 टोर *tor*, 9, 24, 857.
 टौर *tonr*, 857.
 टोर सागाप्रब *tor lagāëb*, 857.
 टोरा *tōra*, 9.
 टोरी *tori*, 857.
 टोह *toha*, 1045.

॥ ठ th ॥

थकार *thakar*, 106.
 थकरा *thakra*, 68.
 थकरी *thakri*, 747.
 थकवा *thakwa*, 464.
 थकःहरिया *thakhariya*, 837.
 थकुवा *thakua*, 1272.
 थग *thag*, 1486.
 थटर *thatar*, 1250.
 थटरा *thatra*, 1051.
 थटरी *thatri*, 213, 245, 247, 318,
 649.
 थटरी *thathri*, 1051.
 थठेर *thather*, 986.
 थठेरा *thathera*, 548, 983, 986.
 थठेरी *thatheri*, 548, 558.
 थठेरो *thathero*, 896, 983, 987.
 थडुवाता *tharbāta*, 233.
 थडिया *thariya*, 473.

थहार *tharhāñ*, 828.
 थडिया *tharhiya*, 828, 1033, 1073,
 1183, 233, 473.
 थप्पा *thappa*, 533, 569, 590.
 थमरा *thamra*, 1158.
 थरन्पचरा *tharpachra*, 251.
 थररा *tharra*, 123, 858.
 थरिया *thariya*, 1033.
 थस *thas*, 800.
 थसा *thasa*, 533.
 थसा *thassa*, 533.
 थसर *thasar*, 1247.
 थहरा *thakra*, 1114.
 थारंठ *thāinth*, 1158.
 थारंठ चोप्रब *thāinth hoëb*, 1158.
 थकुर *thakur*, 383, 407, 975, 1208.
 थकुर भोग *thakur bhog*, 975.
 थठ *thāt*, 585, 1244, 1245.

- ठाँठी *thanthi*, 682.
 ठार *thār*, 26.
 ठारहा *thārha*, 26.
 ठामे *thāme*, 115 (footnote).
 ठारिक *thārik*, 834.
 ठाँव *thānw*, 747, 1247.
 ठाँस *thāns*, 534.
 ठासा *thāsa*, 534.
 ठिकन्दा *thikra*, 511, 793.
 ठिकदिवा *thikariya*, 1263.
 ठिकरा *thikra*, 563.
 ठिकराहू *thikrahu*, 793.
 ठिकरिवा *thikariya*, 793.
 ठिकरी *thikri*, 1262.
 ठिकरौस *thikraul*, 793.
 ठिकर *thikkar*, 563.
 ठिगुरियाप्रह *thinguriyāēl*, 1076.
 ठिया *thiya*, 404, 408.
 ठिषिवा *thiliya*, 432, 713.
 ठिवा *thiwa*, 404.
 ठीकर *thikar*, 793.
 ठीका *thika*, 1040, 1210.
 ठीका के लीस *thika ke lī*, 1040.
 ठीकेदार *thikedār*, 1210.
 ठीकेदारी *thikedāri*, 1210.
 ठीचा *thīncha*, 45.
 ठीचा *thīha*, 404, 408.
 ठुडा *thuttha*, 987.
 ठुथा *thuntha*, 987.
 ठुगन्ना *thunka*, 385.
 ठुररी *thurri*, 1272.
 ठुरियाप्रह *thuriyāēl*, 1076.
 ठूठा *thūtha*, 1107.
 ठूरी *thuri*, 1272.
 ठेका *thēka*, 953.
 ठेकनी *thekni*, 464.
 ठेकरा *thekrā*, 106, 612.
 ठेकवा *thekwa*, 89, 464.
 ठेकुवा *thekua*, 1272.
 ठेकुरी *thekuri*, 1250.
 ठेगन्ना *thengna*, 464.
 ठेगनी *thengni*, 654.
 ठेगुनी *thenguni*, 654.
 ठेगुरी *thegunri*, 654.
 ठेगनी *thenghni*, 362.
 ठेगुनी *thenghuni*, 654.
 ठेठिवास *thenthivāl*, 319.
 ठेठिवास नार *thenthivāl nād*, 319.
 ठेवन्ना *thevka*, 952.
 ठेवरी *thevri*, 236.
 ठेववा *thevua*, 389.
 ठेवना *thevna*, 1010.
 ठेवने *thevunen*, 1159.
 ठेक *thek*, 77, 764.
 ठेकर *thekar*, 106.
 ठेका *theka*, 108, 464.
 ठेकी *theki*, 401.
 ठेकुर *thekur*, 106.
 ठेग *theng*, 654.
 ठेगा *thenga*, 654.
 ठेगी *thengi*, 654.
 ठेठा *thentha*, 2, 825.
 ठेठा के जोत *thentha ke jot*, 825.
 ठेठी *thenthi*, 2, 29.
 ठेठी कोदार *thenthi kodār*, 28.
 ठेपी *thepi*, 401, 81.
 ठेस *thel*, 236.
 ठेवा *theva*, 91, 325, 286, 404, 408, 527, 1141.
 ठेवा *thaiva*, 45.
 ठेवा *thaincha*, 45.
 ठोकना *thokna*, 600.
 ठोकरा *thokra*, 106, 1075.
 ठोठिवारी *thonthiyāri*, 1074.
 ठोपारी *thopāri*, 1015.
 ठोकव *thokav*, 853, 1484.
 ठोकर *thokar*, 106.
 ठोकल *thokal*, 853.
 ठोरी *thori*, 1272.
 ठोसा *thonsa*, 534.

॥ उ d ॥

- दगर *dagar*, 941.
 दगरग्र *dagran*, 106.
 दगरगना *dagarna*, 459.
 दगग्रा *dagra*, 44, 47, 603 714.
 दगग्रिन *dagrin*, 1400.
 दगग्री *dagri*, 44.
 दंगौनी *dangauni*, 887.
 दग्गी *daggi*, 1130.
 दङ्गा *danga*, 996.
 दधग्राप्रब *daghräb*, 1098.
 दंढकी *dantki*, 1024.
 दंढका *dantuka*, 896.
 दडौका *datauka*, 654.
 दंङ्गर्वास *danrwäns*, 375.
 दंङ्गिया *danriya*, 154, 225, 247.
 दंङ्गि *danreri*, 833.
 दंङ्गि *danrera*, 225.
 दंङ्गि *danreri*, 919.
 दंङ्गि *darenri*, 225.
 ददुवा *darhua*, 1043.
 ददुवा तेल *darhua tel*, 1043.
 दंङ्गि *danrheri*, 188.
 दडा *danta*, 191, 213, 223, 236,
 247, 335a, 414, 431, 508, 510,
 654.
 दडी *danti*, 60, 415, 455, 335a, 888,
 1024, 1315.
 दडी दौब *danti dāwab*, 888.
 दद कसखल *dand kamandal*, 782.
 ददा *danda*, 213, 223, 235, 414,
 416, 611, 931, 940, 1250.
 दडी *dandi*, 415, 508, 598, 644.
 दपण्डन *daptan*, 306, 457.
 दपण्डी *dapti*, 305.
 दपाडी *daphāli*, 1456.
 दभरी *dabri*, 713.
 दबल *dabal*, 1000.
 दबल केराव *dabal kerāo*, 1000.
 दभरी *dabhi*, 137.
 दबु *dabbu*, 319 g & l, 305, 438,
 450, 458.
 दबु *dabbu*, 683, 711.
 दभकल *dabhkal*, 1272.
 दभका *dabhka*, 1272.
 दभको *dabhko*, 1066.
 दभको *damko*, 68.
 दभकौला *damkaula*, 68.
 दभरकाव *damardāk*, 1456.
 दभार *damār*, 848, 852.
 दभारा *damāra*, 848, 852.
 दभरकौला *damhāua*, 68.
 दभ *damp*, 29.
 दभरो *damharo*, 1075.
 दर *dar*, 1075.
 दंङ्ग *danrkas*, 376.
 दलङ्गकना *dalyhakna*, 1381.
 दलङ्गी *dalni*, 641.
 दलिया *daliya*, 44, 284, 442.
 दहरा *dahra*, 1125.
 दधग्राप्रब *dahräb*, 1098.
 दधरी *dahri*, 1125.
 दार *dāi*, 417.
 दारन *dāin*, 1453.
 दाक *dak*, 1084, 1085, 1088, 1456.
 दाकनी *dakni*, 156.
 दाकिनी *dakini*, 1088.
 दंग *dāng*, 103, 654.
 दंगर *dāngar*, 1094, 1183.
 दंढ *dānt*, 880, 896, 983, 987, 990,
 1024, 1183.
 दंढा *dānta*, 896.
 दंढी *dānti*, 896, 983, 987, 990,
 1483.
 दंढ *dānth*, 880, 896, 990, 995,
 1024.
 दंङ्ग *dānr*, 237, 792, 833, 954, 1010.

- दाँदर *dānrar*, 198.
 दाँदा *dānra*, 376.
 दाँदी *dānri*, 75, 60, 247, 335a.
 दादी *dārhi*, 1037, 1161.
 दाबर *dābar*, 792, 832.
 दाबा *dāba*, 137, 713.
 दाभा *dābha*, 450.
 दाभी *dābhi*, 815, 957, 1001, 1075, 1183.
 दाम *dām*, 1066.
 दारब *dārab*, 1350.
 दाद *dal*, 1347.
 दाद दौरा *dal daura*, 1347.
 दादा *dala*, 44, 325, 1347.
 दादी *dāli*, 44, 45, 1194.
 दांस *dāns*, 415.
 दांसन *dānsan*, 390.
 दाही *dāhi*, 726 (footnote), 868.
 दिठौरी *dithauri*, 1045.
 दिड़िया *diriya*, 1073.
 दिड़िया मिरन्वार *diriya mirchāi*, 1073.
 दिँदोर *dinror*, 66.
 दिन्दी *dindi*, 994, 1001, 1004, 1017, 1029.
 दिन्दी लागल है *dindi lāgal hai*, 1001.
 दिफी *diphi*, 1009.
 दिबरा *dibra*, 563.
 दिबरी *dibri*, 713.
 दिबिया *dibiya*, 535, 658.
 दिब्बा *dibba*, 658.
 दिब्बी *dibbhi*, 957, 986, 994, 1001, 1018.
 दिबा *dilla*, 793.
 दिडी *dilli*, 478.
 दिसनिस *dismil*, 1499.
 दिन्वार *dihwār*, 1203, 1434, 1438, 1456.
 दिन्वार पूजा *dihwār pūja*, 1434.
 दिहांस *dihāns*, 784, 790, 1226.
 दिही *dihī*, 1218.
 दिँदा *dinra*, 784a.
 दिँदी *dinro*, 784a.
 दिँदी *dinri*, 994, 1017.
 दीब *dib*, 547.
 दीबा *diba*, 658.
 दीभी *dibhi*, 986, 994.
 दीरी *dīri*, 1004.
 दील *dil*, 95, 790, 791, 793.
 दीला *dila*, 95, 788.
 दीलो *dilo*, 95.
 दीध *dih*, 784, 790, 793, 796, 1234.
 दुँड़िया *duñriya*, 1107.
 दुप्पा *duppha*, 1272.
 दुभा *dubbha*, 677, 690.
 दुब्बी *dubbhi*, 1018.
 दुबा *dūba*, 1458.
 दुबो गेले *dūbo gelai*, 1477.
 देरुहिया *deurhiya*, 1479.
 देरुही *deurhi*, 1254.
 देरुहा *deorha*, 1479.
 देगची *degchi*, 448, 711.
 देगौनी *dengauni*, 887.
 देरुका *deñrauka*, 1010.
 देरुपट्टा *derhpatta*, 730.
 देरुपट्टी *dherpatti*, 730.
 देरुसेरी *derhseri*, 912, 1500.
 देरुहा *derhua*, 1183.
 देरुहा जोर *derhaurā jor*, 110.
 देवोरा *deyora*, 1075.
 देहरी *dehri*, 77, 310, 1436.
 देग *deg*, 711, 1491, 1492, 1495.
 देंग *deng*, 103.
 देंगी महुचा *dengi machhua*, 232.
 देद *derh*, 473, 792, 1127, 1479.
 देद कौचा *derh kaua*, 792.
 देद खम्हा *derh khamha*, 473.
 देद पैसे रुपैया *derh paise rupaiya*, 1479.
 देहा *derha*, 1479.

डेही *derhi*, 1475.
 डेफ *deph*, 957.
 डेफ निहसस *deph nikaal*, 957.
 डेफी *dephi*, 957.
 डेव *deb*, 1101.
 डेवम *dhebhan*, 40.
 डेर *der*, 1110.
 डेरा *dera*, 1236, 1237, 1254.
 डेही *deli*, 44, 46, 319f.
 डेवद *dewarh*, 1117.
 डैया *daiya*, 1453.
 डोकनी *dokni*, 717.
 डॉङ्गा *donrha*, 734.
 डोभरा *dobhra*, 833.
 डोरबन्दा *dorbandha*, 363.
 डोहरा *dohra*, 319h, 305.
 डोहरी *dohri*, 462.
 डोहला *dohla*, 319h.
 डोषा *doa*, 450, 718.
 डोर *doi*, 449, 718, 1380.
 डोष्ट *doët*, 231.
 डोषा *doäa*, 718.
 डोकी *doki*, 44, 661, 718.
 डोंगा *donga*, 450.

डॉङ्ग *donr*, 646.
 डॉङ्गा *donra*, 17, 734, 889.
 डॉङ्गी *donri*, 646.
 डोभव *dobhab*, 857.
 डोभा *dobna*, 316, 857, 864.
 डोम *dom*, 1419.
 डोमा *doma*, 786, 996.
 डोमा करै *doma karail*, 786.
 डोर *dor*, 113, 115, 117, 949.
 डोरी *dori*, 115, 117, 145, 216, 362, 398, 425, 470, 475, 642, 748, 949.
 डोरीक *dorik*, 359.
 डोरीक सर *dorik sar*, 359.
 डोरो *doro*, 1020.
 डोळ *dol*, 694, 695, 720, 924, 929, 1290.
 डोळ कदुई *dol karhui*, 1290.
 डोळी *doli*, 241, 247.
 डोळे *dole*, 1087.
 डोहट *dohat*, 231.
 डोहर *dohar*, 794.
 डोही *dyorhi*, 828.
 डोंगा *dyaurha*, 1092.

॥ ड ॥

डक *dhak*, 1499.
 डकडकिया *dhakdhakiya*, 68.
 डकना *dhakna*, 84, 544, 700, 711, 713, 717.
 डकनी *dhakni*, 438, 713, 1422.
 डकिया *dhakiya*, 44.
 डंचरी *dhanchri*, 585.
 डहा *dhattha*, 362A, 896, 983, 986, 987, 990, 1153.
 डहेरा *dhathera*, 986.
 डहु *dhaddha*, 1468c, 1472 ; Appendix, 14.
 डपना *dhapna*, 79, 700, 711.
 डपौना *dhapauna*, 562.

डपडपना *dhabdhabna*, 68.
 डपरी *dhabri*, 787.
 डरका *dharka*, 1188, 1173.
 डरकी *dharki*, 363.
 डरनिहार *dharnihâr*, 943.
 डरनी *dharni*, 564.
 डरनी चकुरी *dharni akuri*, 564.
 डरुवा *dharua*, 215, 224.
 डंरुवा *dhanrua*, 215.
 डरुवाला *dharuwāla*, 561.
 डलकौवा *dhalkaua*, 68.
 डही *dhahi*, 67.
 डकमि *dhakani*, 713.
 डकर *dhakar*, 1164.

धाका *dhāka*, 44.
 धाकी *dhāki*, 44, 1055.
 धाको *dhāko*, 1234.
 धाँचा *dhāncha*, 585.
 धाठ *dhāth*, 895, 1182, 1158, 1416.
 धाठा *dhātha*, 96, 724, 1182.
 धाँडा *dhāntha*, 362A.
 धारा *dhāra*, 560.
 धारहा *dhārha*, 751, 1080.
 धारी *dhārhi*, 1080.
 धाब *dhāb*, 787.
 धाबली *dhābli*, 1000.
 धाबा *dhāba*, 1242.
 धाभ *dabh*, 1004.
 धारव *dhārab*, 1451.
 धारा *dhāra*, 582.
 धारवा *dhārva*, 224.
 धाला *dhāla*, 197, 216.
 धालुआ *dhālūā*, 224.
 धाँसी *dhānsi*, 1173.
 धाह *dhāh*, 792.
 धिबरी *dhibri*, 325, 417.
 धिमका *dhimka*, 713.
 धीहारी *dhīdhāri*, 1308.
 धीबर *dhībar*, 790.
 धुरका *dhurka*, 918.
 धुआ *dhulla*, 894.
 धुसमार *dhusmār*, 1098.
 धुसियाब *dhusiyāb*, 1098.
 धुसियावा *dhusiyāva*, 1098.
 धूस *dhūs*, 1098.
 धुंस *dhūns*, 1098.
 धूस मारव *dhūs mārāb*, 1098.
 धुंस मारव *dhūns mārāb*, 1098.
 धुसा *dhūsa*, 1098.
 धुसा मारव *dhūsa mārāb*, 1098.
 धुह *dhūh*, 791, 793.
 धुही *dhūhi*, 791, 793.
 धेनवांस *dhenwāns*, 66.
 धेकुवा *dhenkua*, 256, 274, 726.

धेकुवास *dhekuaś*, 66.
 धेकुवा *dhenkula*, 928.
 धेकुवा *dhenkua*, 274.
 धेबुवा *dhebua*, 1497.
 धेमनी *dhemni*, 1280.
 धेरिया *dhenriya*, 1073.
 धेरिया मिरचार *dheñriya mirchāi*,
 1073.
 धेलमास *dhelmās*, 66.
 धेलवा *dhelwa*, 1456.
 धेलवा गोसाँई *dhelwa gosāin*, 1456.
 धेलवांस *dhelwāns*, 66.
 धेलवा *dhelha*, 1456.
 धेलवा पीर *dhelha pīr*, 1456.
 धेलौरी *dhelauri*, 66.
 धेक *dhenk*, 291.
 धेका *dheka*, 608.
 धेका *dhenka*, 256, 261, 274, 608,
 726, 1250.
 धेकी *dhenki*, 431, 464, 608, 928, 1250.
 धेकुल *dhenkul*, 608, 928, 931.
 धेद *dhenrh*, 1017.
 धेदी *dhenrhi*, 994, 996, 1001, 1004,
 1029, 1017.
 धेदी लागल है (or बा) *dhenrhi lāgal*
hai (or ba), 1001.
 धेन *dhen*, 1158.
 धेन के दूध *dhen ke dūdh*, 1158.
 धेनु *dhenu*, 1114.
 धेपी *dhempi*, 1051.
 धेमा *dhema*, 541.
 धेरी *dheri*, 82, 849, 890, 892, 893.
 धोलना *dholna*, 765.
 धोलना चौकी *dholna chauki*, 765.
 धोसवा *dhoswāh*, 949.
 धोका *dhoka*, 1125, 1265.
 धोंगा *dhonga*, 372.
 धोंदी *dhonrhi*, 1017.
 धोही *dholi*, 1053, 1054, 1055.
 धोष *dhos*, 949.

॥ त ॥

तठ *ta*, 356, 363, 829, 833.

तँ *tañ*, 1451.

तकरै *takrai*, 1090.

तकण्डो *taklo*, 741 (footnote).

तकिचा *takiya*, 637.

तकेचा *takeya*, 637.

तकर *takkar*, 1272.

तकण्डपोच *takhatpos*, 635.

तकण्ड रवाँ *takht rawān*, 241.

तकण्डा *takhta*, 222, 414, 457, 467,
475, 587, 832, 1214.

तकण्टी *takhti*, 222, 587.

तकाणा *takhāna*, 1241.

तगधरी *tagdhari*, 491.

तगन्ही *taghi*, 108.

तगाड़ *tagār*, 430.

तगाड़ी *tagāri*, 39, 430, 714.

तगार *tagār*, 430, 1014.

तगावी *tagāwi*, 1187, 1190.

तङ्ग *tang*, 226.

तङ्गी *tangi*, 128 (footnote), 130.

तज *taj*, 1381.

तङ्क *tarak*, 223, 1252, 1257.

तङ्कतङ्कवाँ *tartarwān*, 241.

तङ्काका *tarāka*, 585b.

तँतवा *tantua*, 355.

ततुरियाग्रह *taturiyāgrh*, 1076.

तँदूर *tandūr*, 446.

तन *tan*, 1375.

तनाव *tanāw*, 390.

तनिका *tanika*, 1056.

तनर *tanūr*, 446.

तन्नी *tanni*, 642.

तपणाच *tapnāh*, 800.

तब *tab*, 356, 393, 1088, 1113.

तबण्जारी *tabjāri*, 1201.

तबच *tabay*, 1084.

तबण्डक *tablak*, 1466.

तबाक *tabak*, 711, 713.

तबाक *tabākh*, 711.

तँबिया *tambiya*, 3191.

तमन्हेच *tamghail*, 693.

तमन्हेका *tamghaila*, 693.

तमन्नी *tamni*, 865, 867.

तमन्हा *tamha*, 689.

तमन्हेड़ी *tamheri*, 675.

तमाकुपरोश *tamākupharosh*, 464.

तमाकुल *tamākul*, 1021.

तमाकुलवाला *tamākulwāla*, 464.

तमाकुलवाला *tamākulwāla*, 464.

तमाकु *tamāku*, 1021, 1026, 1452.

तमान *tamān*, 727.

तमासा *tamāsa*, 128 (footnote), 356.

तमिया *tamiya*, 319g, 372, 670.

तमियाँ *tamiyān*, 3191.

तमहेड़ा *tamhera*, 556.

तर *tar*, 1234.

तररै *tarai*, 751.

तरकही *tarkatti*, 378, 713.

तरकारी *tarkāri*, 1073.

तरकी *tarki*, 764.

तरकोंका *tarkonka*, 1073.

तरक *tarakh*, 26.

तरन्हा *tarchha*, 50.

तरन्ही *tarchhi*, 39, 126, 606.

तरन्जुचा *turjūa*, 640.

तरन्जूरै *tarjui*, 47, 462, 555, 640.

तरन्जू *tarju*, 640.

तरन्हार *tarjhār*, 888.

तरन्गर *tarangar*, 1252.

तरन्पचरा *tarpachra*, 251.

तरन्बूच *tarbūj*, 1064.

तरन्बूजा *tarbūja*, 1064.

तरन्बानी *taryāni*, 788.

तरन्रा *tarra*, 1493.

तरल *taral*, 1272.

- तरन्हा *tarla*, 474.
 तरन्वार *tarvār*, 655.
 तरन्चरूंख *tarsail*, 938.
 तरन्चिपार *tarsiwāi*, 792.
 तरन्चैखा *tarsaila*, 14, 938.
 तरन्चोचा *tarsoa*, 922.
 तरचन्ना *tarahra*, 1241.
 तरन्हा *tarha*, 1493.
 तरागोट्ठन्सरग *tarāgotsarg*, 1459.
 तराजू *tarāju*, 47, 462, 555, 640.
 तराच *tarāy*, 751.
 तराशी *tarāshi*, 1411.
 तरी *tari*, 788, 789, 792, 901, 914, 960.
 तरु *taru*, 726 (footnote).
 तरेर *tarer*, 1262.
 तरैरा *tarera*, 225, 1246, 1262.
 तरैनी *taraini*, 461.
 तरैला *taraila*, 12.
 तरैली *taraili*, 12.
 तरौद *tarōi*, 1069.
 तरौटा *tarauta*, 620.
 तरौडी *tarauri*, 284.
 तरौना *tarauna*, 49, 461.
 तरौनी *tarauni*, 461.
 तलार *talāi*, 916.
 तलाव *talāo*, 916.
 तलेया *talaiya*, 916 (footnote).
 तलौटा *talauta*, 620.
 तवक *tavak*, 226, 765.
 तवा *tava*, 676.
 तसत *tasat*, 711.
 तसन्तरी *tastari*, 678, 711, 713.
 तसन्तर *tasmā*, 1272.
 तसन्ना *tasna*, 226, 415, 470.
 तसन्हा *tasna*, 664.
 तसन्हा *tasla*, 664, 666.
 तसन्ही *tasli*, 665.
 तसुर *tassur*, 1490.
 तसन्धाना *takkhāna*, 1241.
 तसन्जारी *tahajjāri*, 1201.
 तसन्बन्ध *tahband*, 726.
 तसन्बीज *tahbil*, 1463b.
 तसन्मद *tahmad*, 726.
 तसन्चिखन्दार *tahsildār*, 1208.
 तहाँ *tahān*, 655.
 तही *tahi*, 726, 739.
 तार *tāi*, 676, 713.
 ताख *tākh*, 1253.
 ताखा *tākha*, 1253.
 ताखी *tākhi*, 725.
 तागा *tāga*, 123, 1383.
 तांगा *tānga*, 178, 214, 224.
 ताज *tāj*, 725, 1272.
 ताज खानी *tāj khāni*, 1272.
 ताड़ *tār*, 379, 1092.
 ताड़व *tārab*, 1484.
 ताड़ी *tāri*, 378, 379, 713.
 तांत *tānt*, 113, 335d.
 तांती *tānti*, 355.
 तांतो *tānto*, 355.
 ताडी *tādhi*, 784b.
 तान *tān*, 224, 245, 249, 322.
 ताना *tāna*, 363.
 तानि *tāni*, 1234.
 तानी *tāni*, 358, 642.
 तानी करव *tāni karab*, 358.
 ताबन्दान *tābdān*, 1249.
 तांबा *tāmba*, 668, 1451.
 तामब *tāmab*, 865, 867.
 तामा *tāma*, 319h, 343.
 तामिया *tāmiya*, 319g.
 तामी *tāmi*, 670.
 तामी *tāmmi*, 372.
 ताम्बूज *tārbhuj*, 1064.
 तार *tār*, 326, 379, 1084, 1456 ;
 Appendix, 14.
 तारक चहा *tārak chhaja*, 68.
 तारन *tāran*, 1252.
 तारा *tāra*, 585d.
 तारी *tāri*, 379, 999 (footnote).

- तारीखवार *tarikhoar*, 1470.
 ताल *tal*, 916.
 ताला *tala*, 1250.
 तालुका *taluka*, 1207, 1283.
 तालुकादार *talukadar*, 1207.
 तालुकादारी *talukadari*, 1207.
 ताव *taw*, 289, 455.
 तावा *tawa*, 226, 676, 711, 860, 922.
 तावा दूद गेल *tawa dūd gel*, 922.
 तावीज *tawij*, 754, 765.
 तास *tās*, 1272.
 तास खानी *tās khāni*, 1272.
 तासन *tāsan*, 362.
 तासन करव *tāsan korav*, 362.
 ताहि *tāhi*, 1234.
 तिजनी *tiumi*, 733.
 तितन्ही *titli*, 1183.
 तिमिही *titili*, 1074, 1075.
 तिमोर *tiōi*, 1183.
 तिक्का *tinka*, 1310.
 तिमकोनिया *tinkoniya*, 833.
 तिमखण्डी *tinkhandi*, 762.
 तिमखण्डिया *tinchkhaliya*, 769.
 तिमन्जान *tinjant*, 926.
 तिमन्दा *tindara*, 1286.
 तिमन्गा *tinmaga*, 768.
 तिमन्पखी *tinpakhi*, 1427.
 तिमन्पखी के पिन्दा *tinpakhi ke pinda*,
 1427.
 तिमन्पतिवा *tinpatiya*, 1183.
 तिमन्पख *tinpkhal*, 418.
 तिमन्पौषा *tinpaua*, 1500.
 तिमन्पसिखा *tinphasila*, 803.
 तिमन्पहा *tinphalla*, 418.
 तिमन्पडो *tinlatthi*, 926.
 तिमन्सेरा *tinsera*, 1500.
 तिमन्सेरी *tinseri*, 1500.
 तिपाद *tipāi*, 633.
 तिमन्तिवा *tirtiya*, 1444.
 तिमन्पख *tirpahal*, 418.
 तिमन्पख *tirpaha*, 418.
 तिमन्वार *tirpāi*, 319j.
 तिमन्वाच *tirpāl*, 132.
 तिमन्वाच *tirpāl*, 418.
 तिमन्वह *tirvāl*, 1112.
 तिमन्ती *tirānti*, 1039.
 तिमन्ती *tirānti*, 1424.
 तिमिज *tirij*, 1468a and b, 1469,
 1470, 1472.
 तिमिज खसरा *tirij khasra*, 1471.
 तिमिज जिमिखवार *tirij jiminoar*,
 1468a, 1470; Appendix, 5.
 तिमिज तारीखवार *tirij tarikhoar*,
 1470; Appendix, 1a.
 तिमिज पटेवारी *tirij patevāri*, 1468b,
 1471; Appendix, 11.
 तिमिज मोफरीद *tirij mofrad*, 1470,
 1471.
 तिमिज मोखण्डी *tirij molhaki*, 1472.
 तिमिज लगीत *tirij laggit*, 1470,
 1471; Appendix, 10a.
 तिमिज वासिल बाकी *tirij wasil baki*,
 1472.
 तिमिरी *tiri*, 363.
 तिम *til*, 1084, 1423.
 तिमक *tilak*, 1287, 1289, 1318, 1429.
 तिमकवारी *tilkatri*, 1272.
 तिमकन्देखा *tilakdeva*, 1318.
 तिमकखण्ड *tilkahrū*, 1318.
 तिमकुड *tilkut*, 1272.
 तिमण्डी *tilthi*, 896.
 तिमण्डी *tildāni*, 734.
 तिमणी *tilri*, 765.
 तिमण्डी *tilānjur*, 1423.
 तिमण्डी देव *tilānjur dev*, 1423.
 तिमण्डी *tilāthi*, 896.
 तिमिखिया *tilikiya*, 1318.
 तिमिया *tiliya*, 799.
 तिमिया कोदी *tiliya korhi*, 799.
 तिमौरी *tilauri*, 1272.

तिळक *tillak*, 1318.
 तिळी *tilli*, 592, 1045.
 तिसजौरी *tisjauri*, 1272.
 तिसरिया *tisariya*, 842.
 तिसरी *tisri*, 842, 907.
 तिसिबाउर *tisiyaur*, 1272.
 तिसिचौटा *tisiauta*, 768.
 तिसौर *tisaur*, 884, 885.
 तिहैया *tihaiya*, 907.
 तीज *tij*, 182, 183, 200, 1443.
 तीनिर *titir*, 1088.
 तीथा *titha*, 937, 952.
 तीन *tin*, 953, 1006, 1088, 1089.
 तीन ठेचका *tin theika*, 953.
 तीन पटावन तेरच कोइन *tin patāwan
terach koran*, 1006.
 तीनि *tini*, 1089.
 तीनु *tinu*, 393, 1025.
 तीनो *tino*, 1486.
 तीथन *tiyan*, 1073.
 तीर *tir*, 1456.
 तीरच *tirath*, 1460.
 तील *til*, 1045, 1089.
 तीली *tīli*, 498, 502, 592.
 तीसी *tisi*, 356, 1045.
 तुकमा *tukma*, 729.
 तुम *tum*, 1087.
 तुमन्ही *tumri*, 782.
 तुम्बा *tumba*, 715, 782.
 तुम्मा *tumma*, 715, 782.
 तुम्पर *turpai*, 748.
 तुम्हा *turha*, 1456.
 तुम्हार *turāi*, 731.
 तुम्क *turuk*, 999 (footnote).
 तुम्गन्गा *tulangra*, 170.
 तुम्बुली *tulbuli*, 996.
 तुम्बुली *tulsi*, 414, 977, 1188,
1451.
 तुम्बुली ताँबा *tulsi tāmba*, 1451.
 तुम्बुली फूल *tulsi phul*, 977.

तुला *tula*, 1090.
 तुलार *tulāi*, 222.
 तुलावा *tulāwa*, 167, 168, 187, 188,
204, 221, 222.
 तू *tū*, 1084.
 तुम्ब *tūnab*, 334.
 तुम्ब *tūnnab*, 334.
 तुम्ब *tūmab*, 334.
 तुम्बा *tūma*, 715, 782.
 तूर *tūr*, 333.
 तूरत बा *tūrat ba*, 240.
 तूरब *tūrab*, 1024.
 तूरल *tūral*, 240.
 तूरे *tūre*, 1486.
 तुल *tul*, 640, 1470.
 तेबाह *teāh*, 1278.
 तेकानी *tekhāni*, 173.
 तेकुना *tekuna*, 1059.
 तेकुरा *tekura*, 907.
 तेकुरी *tekuri*, 907.
 तेकुली *tekuli*, 907.
 तेखरा *tekhra*, 820.
 तेखुरी *tekhuri*, 907.
 तेघाँव *teghānw*, 953.
 तेघावा *teghāwa*, 953.
 तेजता *tejatta*, 926.
 तेतरी *tetri*, 1397.
 तेतला *tetla*, 204.
 तेतलिबा *tetaliya*, 204.
 तेतार *tetar*, 1183.
 तेतारी *tetāri*, 1183.
 तेतुला *tentula*, 204.
 तेधरी *tedhri*, 1097.
 तेधुरा *tedhura*, 1097.
 तेपर *tepai*, 633.
 तेपकी *tepakhi*, 996.
 तेपचल *tepalal*, 319j, 418.
 तेपार *tepāi*, 633.
 तेपहा *tephalla*, 403.
 तेबिदा *tebihā*, 1278.

तेरगा *terra*, 959.
 तेरगाच *telchat*, 1074.
 तेरगाही *telatthi*, 926.
 तेरगाहीना *telbhānra*, 668.
 तेरगाही *telri*, 765, 1039.
 तेरगाह्या *telhanda*, 663, 713.
 तेरगाहन *telhan*, 1045.
 तेरगाहन तीची *telhan tisi*, 1045.
 तेरगाहीना *telhānri*, 713.
 तेराच *teldy*, 713.
 तेरिचा *tekiya*, 786.
 तेरिचा केराच *tehiya kewal*, 786.
 तेवारे *tewāre*, 1098.
 तेवारे जोतक *tewāre jotal*, 1098.
 तेसरी *tesri*, 907.
 तेसरो *tesro*, 1007.
 तेसरावन *tehrāwan*, 820.
 तेकर *tekar*, 823, 1086.
 तेकार *tekhār*, 820.
 तेगा *tenga*, 1294.
 तेजी *tenji*, 1039.
 तेतर *tetar*, 1397.
 तेथक *tephal*, 403, 418.
 तेराच *terah*, 1006, 1088.
 तेक *tel*, 347, 1043, 1045, 1308,
 1378, 1458.
 तेक चदाप्रच *tel charhāeb*, 1378.
 तेची *tehi*, 255, 572.
 तेसर *tesar*, 1007.

तेसर (or तेसरो) पढावन (or पानो) *tesar*
 (or *tesro*) *aptāwan* (or *pāni*), 1007.
 तेसार *taiyar*, 1118.
 तेती *tainti*, 757.
 तोडाप्रच *torāeb*, 888.
 तोवगा *tobra*, 134, 227.
 तोरना *torna*, 585b.
 तोरियक *toriyath*, 896.
 तोरिचा *toriya*, 1119.
 तोरिचाही *toriyāthi*, 896.
 तोरिचान *toriyān*, 1119.
 तो *to*, 1091.
 तोत्र *togar*, 569.
 तोहन *toran*, 1042.
 तोकच *torab*, 240, 981.
 तोडा *tora*, 757.
 तोर *tor*, 664 (footnote).
 तोरी *tori*, 823, 1045.
 तोला *tola*, 1498, 1499.
 तोसक *tosak*, 637.
 तोहार *taulāi*, 914.
 तो *taun*, 1087.
 तोनी *tauni*, 733.
 तोल *taul*, 1118.
 तोला *taula*, 69, 143, 319i, 368,
 378, 437, 713.
 तोची *tauli*, 665.
 त्रितिवर *tritibar*, 1278.
 तों *tyon*, 737.

॥ थ th ॥

थक *thak*, 1034.
 थकरी *thakri*, 747.
 थकुररी *thakurāi*, 867.
 थका *thakka*, 531.
 थनमार *thanmār*, 1477.
 थनेलिचाही *thanaiiyāhi*, 1395.
 थनेली *thanaili*, 1395.
 थपरी *thapri*, 137, 713.

थपुचा *thapua*, 624, 1262.
 थम *tham*, 500.
 थमनी *thamni*, 613.
 थमुचा *thamua*, 1259.
 थमुचा *thamhua*, 1259.
 थरिचा *thariya*, 680, 460.
 थला *thalla*, 500.
 थवरी *thavāi*, 420, 1264.

थडसल *thahusal*, 1094.
 थकल *thakal*, 657.
 थान *thān*, 1455.
 थापी *thāpi*, 282, 307, 424, 431.
 थारी *thāri*, 460, 680, 681, 682, 1316,
 1401, 1408.
 थारी बजाप्रब *thāri bajāeb*, 1401.
 थाल *thāl*, 718, 460
 थुकुवा *thukka*, 1173.
 थुन्ही *thunhi*, 940.
 थुम्भा *thumbha*, 363.
 थुम्भी *thumbhi*, 363, 1259.
 थूसा *thūsa*, 1048.
 थुनु *thūnu*, 500.
 थुन्ही *thūnhi*, 1256, 1259.
 थुम *thūm*, 363.

थेवा *thaiya*, 318.
 थेर *thair*, 1118.
 थेसा *thaila*, 734.
 थेसी *thaili*, 734.
 थेसीमार *thailimār*, 1477.
 थोडुन्ही *thorli*, 359.
 थोडुन्री *tholri*, 359.
 थोक *thok*, 531, 1214.
 थोडी *thori*, 359.
 थोप *thop*, 177, 189, 249.
 थोभ *thobh*, 189, 192, 204, 221.
 थोर *thor*, 829.
 थौक *thauth*, 531.
 थौना *thauna*, 500, 1247.
 थौसल *thausal*, 1094.
 थौसा *thausa*, 1094.

॥ द d ॥

दई *dai*, 1295.
 दखिनचा *dakhincha*, 1074.
 दखिनाचा *dakhinācha*, 1074, 1160.
 दखिनाचा सु *dhakhinācha ghyu*, 1160.
 दगन्दार *dagdār*, 1076.
 दगध करब *dagadh karab*, 1416, 1419.
 दगन्नी *dagni*, 359.
 दगन्दिन *dagrīn*, 1400.
 दगन्ही *daghi*, 224.
 दंगाठ *dangāth*, 1079.
 दगियाल *dagiyāl*, 1004.
 दखिनी *dakhhini*, 1057.
 दखिमी *darimi*, 1272.
 ददिवा *darhiya*, 346.
 दन्त *dat*, 1196, 1197.
 दन्तकमन्रा *dant kamra*, 984.
 दन्तन्तर *dantnar*, 1173.
 दन्तभोजनी *datbhajni*, 1197.
 दतुचन *datuan*, 747.
 दंतुचा *dantua*, 216.
 दंतुसा *dantula*, 73.

ददिचौरा *dadiaura*, 1299.
 ददिहर *dadihar*, 1299.
 ददिहार *dadihār*, 1299.
 ददिवाल *dadihāl*, 1299.
 दगन्जाउर *danyājūr*, 1272.
 दनिवाली *daniyāli*, 585a.
 दनौरी *danauri*, 1272.
 दन्त *dant*, 568, 1113, 1173.
 दन्त लहर *dant lahar*, 1173.
 दफन्तरी *daphtari*, 586.
 दफन्दरी *daphdari*, 586.
 दबकन *dabkan*, 81, 309, 713.
 दबन्डा *dabtha*, 549.
 दबन्नी *dabni*, 398.
 दबन्धिया *dabhiya*, 1000.
 दबिया *dabiya*, 439, 583, 1141.
 दबिला *dabila*, 439.
 दबोर *daboi*, 1267.
 दबौटा *dabauta*, 322, 398.
 दम *dam*, 145.
 दमकही *damkatti*, 913.

- दमन्का *damka*, 796.
 दमन्की *damri*, 1497.
 दमन्दाचा *damdamācha*, 472.
 दमन्परिजा *damhariya*, 44.
 दमाच *damāo*, 913, 1471.
 दमाच गळा *damāo galla*, 1471.
 दमाची *damāhi*, 887.
 दम्भी *damṃhi*, 472.
 दर *dar*, 1220, 1479.
 दरखोल *darkhol*, 1153.
 दरज *daraj*, 748.
 दरजी *darji*, 393, 748.
 दरपतन्नी *darpatni*, 1211.
 दरपच *darpan*, 383, 765.
 दरबन्दी *darbandi*, 1220.
 दरन्दाचा *darmāha*, 1185.
 दरम्भी *darmi*, 965e.
 दरग्याबाही *daryābādi*, 769.
 दरग्रा *darra*, 1272.
 दरग्याजा *darwaja*, 1254.
 दरग्याजा *darwajja*, 1249.
 दरग्याजा *darwāja*, 562, 1249.
 दरसनी *darسانی*, 1487.
 दरसुधा *darsūdha*, 238.
 दरसुधा के मलिचा *darsūdha ke maliya*,
 238.
 दरा *dara*, 1272.
 दराज *darāj*, 248, 401.
 दरी *dari*, 750.
 दरीची *darinchi*, 1249.
 दरुद *darūd*, 1432.
 दरीची *darāinchi*, 1249.
 दरोखा *darokha*, 1239.
 दरोजा *dareja*, 1249.
 दरीजा *darauja*, 1249, 1254.
 दलकी *dalki*, 789.
 दलदल *daldal*, 789.
 दलपिठी *dalpitthi*, 1272.
 दलपिठीरी *dalpithauri*, 1272.
 दलपिंता *dalpainta*, 1001.
 दलसग्गा *dalsagga*, 1001, 1272.
 दलसी पूरी *dalhi pūri*, 1272.
 दलान *dalān*, 1239, 1254, 1388.
 दलाही *dalāhi*, 1474.
 दवार *dawar*, 921.
 दवान *dawan*, 832, 954.
 दवार *dawar*, 235, 941.
 दवात *dawāt*, 713, 1034, 1442.
 दवात पूजा *dawāt puja*, 1442.
 दवांची *dawānhi*, 887, 889.
 दस *das*, 711.
 दसकरम *daskarm*, 1425.
 दसगर्दानी *dasgardān*, 1476.
 दसगात्र *dasgatr*, 1425.
 दसपना *daspana*, 711.
 दसवां *daswān*, 1423, 1425.
 दसहरा *dasahra*, 1381, 1393.
 दसहरा के जोड़ा *dasahra ke jora*,
 1381.
 दसहरा खाना *dasahra khāna*, 1393.
 दसाही *dasāhi*, 1425.
 दसेर *daser*, 940.
 दसौरी *dasaurhi*, 1250.
 दसौरी चौकठ *dasaurhi chaukath*,
 1250.
 दसौत *dasaut*, 1358.
 दस *dast*, 711.
 दसगर्दानी *dastgardān*, 1476.
 दसपनाच *dastpanāh*, 711.
 दसा *dasta*, 335h, 706.
 दसी *dasti*, 585, 720.
 दसी कुप्पा *dasti kuppā*, 720.
 दसूरी *dasturi*, 1474.
 दहरी *dahri*, 713.
 दहार *dahār*, 912, 1080.
 दहार महार *dahār mahār*, 912.
 दहि *dahi*, 1162.
 दहिचक *dahiak*, 1198, 1203.
 दहिचक मांगन *dahiak māngan*, 1198.
 दहिन *dahin*, 817.

- दचिन धरेबाव *dahin dharedo*, 817.
 दचिना *dahina*, 827.
 दचिबा *dahiya*, 1074.
 दचियाप्रब *dahiyāḥ*, 1004.
 दचिबाची चाँडी (or कड़ाची) *dahiyāh hānri (or karāhi)*, 138.
 दचिबकी *dahihakki*, 1192.
 दची *dahi*, 138, 713, 990, 1162, 1324.
 दहेज *dahej*, 1283, 1339, 1347.
 दहेंची *dahenri*, 138, 713.
 दाउदी *dāudi*, 956.
 दाखिला *dākhila*, 1467.
 दान्गळी *dāngli*, 184.
 दान्हे *dānre*, 1085.
 दाही *dārhi*, 346, 356.
 दान्त *dānt*, 73, 401.
 दान्त रन्दा *dānt randa*, 401.
 दान्तुषा *dāntuṣa*, 585b.
 दादन *dādan*, 1040.
 दादनी *dādni*, 1028, 1040.
 दान्दर *dāandar*, 868.
 दादा *dādā*, 463.
 दादीबाब *dādībāb*, 1299.
 दान *dān*, 1334, 1457, 1459.
 दाना *dāna*, 856, 904, 1030, 1031, 1268, 1272, 1470.
 दाना दूनी *dāna dūni*, 1268.
 दानाबन्दी, *dānābandi*, 913, 1463a, 1470.
 दानी *dāni*, 447, 1194, 1273.
 दानो *dāno*, 1438.
 दानो पूजा *dāno pūjā*, 1438.
 दाब *dāb*, 168, 322, 439, 457, 583.
 दाबा *dāba*, 319l, 457, 718.
 दाबि *dābi*, 718.
 दाबी *dābi*, 457.
 दाम *dām*, 1487, 1496, 1497.
 दामर *dāmmar*, 889.
 दास *dāl*, 1002n, 1272, 1369.
 दास धोरे *dāl dhoi*, 1369.
 दास पीठी *dāl pithi*, 1272.
 दास शोरे *dāl shoi*, 1369.
 दाव *dāv*, 86.
 दान्वाब *dānwab*, 888.
 दान्वाल *dānwal*, 1119.
 दाना *dāwa*, 1251.
 दानागौर *dāwāgūr*, 655.
 दास *das*, 1456.
 दाह *dāh*, 1416.
 दाह देब *dāh deb*, 1416.
 दिअका *diaka*, 1074.
 दिअंका *dianka*, 1074.
 दिअरख *diarakh*, 1253.
 दिअरखा *diarkha*, 1253.
 दिअरा *diara*, 788.
 दिअंका *diunka*, 1074.
 दिउरी *diuri*, 713.
 दिउली *diulī*, 713.
 दिन *din*, 965, 966, 1087, 1091, 1343.
 दिन गुनी करव *din gunni karab*, 1343.
 दिनिअर *dinihar*, 874.
 दिनुक *dinuk*, 1088.
 दिनौरा *dinaura*, 874, 914.
 दिपन्दान *dipdān*, 780.
 दिपन्दानी *dipdāni*, 780.
 दिपन्रा *dipra*, 702.
 दिपन्रा *dipakra*, 702.
 दिअरी *diyari*, 713.
 दिअंका *diyānra*, 1074.
 दिअर *diyār*, 1074.
 दिअरा *diyāra*, 788.
 दिअरी *diyāri*, 713.
 दिअन्का *diika*, 247.
 दिअर *diwār*, 1074, 1251.
 दिअला *diwāla*, 1486.
 दिअला उखरि गेलेहि *diwāla ukhari gelainhi*, 1486.
 दिअला निकन्सब *diwāla niksab*, 1486.

- दिवाळा निकासण *diwāla nikāsab*, 1486.
 दिवाळा सुध हो जाणव *diwāla sudh ho jāeb*, 1486.
 दिवाळिया *diwāliya*, 1486.
 दिव *dis*, 849 (footnote).
 दिवा *dista*, 335h, 706.
 दिवा *distha*, 335h.
 दिवन्वस *dihlas*, 1116.
 दिवळि *diathi*, 702.
 दिनी *dini*, 874.
 दीप *dip*, 713.
 दीपक *dipak*, 585f.
 दीयत *diyāt*, 702.
 दीयर *diyār*, 784, 788.
 दीया *diya*, 713, 1316, 1423.
 दीयान *diyān*, 1074.
 दीया बाती *diya bāti*, 1423.
 दीरठ *dira*, 788.
 दीरा *dira*, 788.
 दीरी *diri*, 713.
 दीवड *diwat*, 702, 711.
 दीवाल *diwāl*, 247, 1251.
 दीवळ *dīha*, 829, 1113.
 दुवणी *duanni*, 1201, 1499; Appendix, 14.
 दुवरिया *duariya*, 1238.
 दुवार *duār*, 454, 1238, 1247, 1249, 1254, 1319, 1335, 1352.
 दुवार हेंकार *duār chhenkāi*, 1335, 1352.
 दुवार हेंकौनी *duār chhenkāuni*, 1335.
 दुवार पूजा *duār pūja*, 1319.
 दुवार लग्ना *duār lagāi*, 1319.
 दुवारी *duāri*, 247, 1249.
 दुवाळी *duāli*, 17.
 दु *dui*, 1087.
 दुविषाचा *duibiyācha*, 1278.
 दुकानी *dukāni*, 933.
 दुक *dukā*, 1085.
 दुगोळिया *dugoliya*, 639.
 दुगोडी *dugori*, 31, 549.
 दुजना *dujanta*, 926.
 दुजान *dujāt*, 926.
 दुतिबर *duṭibar*, 1278.
 दुदना *dudant*, 1118.
 दुदसर *dudsar*, 970.
 दुदही कंठिया *dudhi kantiya*, 136.
 दुदा *duddha*, 984.
 दुधी *dudhi*, 1422.
 दुधकटुवा *dudhkātua*, 1395.
 दुधकाँर *dudhkānra*, 973.
 दुधगिलास *dudhgilās*, 975.
 दुधघोडू *dudhghōṭṭu*, 984.
 दुधदुतुवा *dudhtutua*, 1395.
 दुधपिळार *dudhpilāi*, 1408.
 दुधभोरो *dudhbhoro*, 984.
 दुधमुँच *dudhmunh*, 1422.
 दुधमुँची *dudhmuñhi*, 1422.
 दुधराज *dudhrāj*, 972.
 दुधा मकर *dudha makar*, 984.
 दुधार *dudhār*, 1117.
 दुधारि *dudhāri*, 1117, 1157.
 दुधिया *dudhiya*, 956, 985, 1075, 1183.
 दुधियाण्ड *dudhiyāṅ*, 957.
 दुधैले *dudhailai*, 957.
 दुध *dunu*, 226 (footnote).
 दुपतिचो *dupatiyo*, 1018.
 दुपहरिया *dupahariya*, 842.
 दुवगळी *dubagli*, 111.
 दुधी *dubhi*, 1183.
 दुमकजा *dumkaja*, 226.
 दुमची *dumchi*, 226.
 दुमुँचा *dumuñhān*, 1239.
 दुर्गा *durga*, 1198.
 दुर्गा पुजार *durga pujāi*, 1198.
 दुर्जन *durjan*, 655.
 दुर्गागन्धन *durāgnaghan*, 1292.
 दुर्गागन्ध *durāgaman*, 1291.

- दुरागौन *duragaun*, 1291.
 दुरस *durus*, 1398.
 दुरौंघ *duraundh*, 1251, 1335.
 दुरौंघा *duraundha*, 1251, 1335.
 दुलहन्त्री *aulahri*, 974.
 दुलहन्धा *dulha*, 1274, 1281, 1383.
 दुलहन्धिन *dulhin*, 1282, 1383.
 दुलारी *dulāri*, 965c.
 दुलार *dullar*, 978.
 दुषैरी *duseri*, 912.
 दुधन्नी *duhni*, 136.
 दुधन्धी *duhanthi*, 414.
 दुहाब *duhāb*, 1159.
 दुहारी *duhāri*, 247, 248, 1238.
 दुहाव *duhāv*, 1201.
 दुहावे *duhāve*, 604.
 दुधिया *duhiya*, 1205.
 दुड *duhu*, 849 (footnote).
 दू *du*, 823, 904, 1113, 1116, 1118, 1479.
 दूधा *dūa*, 908, 1483.
 दूचास *du chās*, 823.
 दू मौल *du taul*, 1118.
 दूध *dūdh*, 990, 1030, 1157, 1158, 1165.
 दूधक *dūdhak*, 1166.
 दूधी *dūdhi*, 786, 956.
 दूनी *dūni*, 1268.
 दूब *dūb*, 1183.
 दूबी *dūbi*, 1308.
 दूभ *dūbh*, 868, 1075, 1188.
 दूभ दाँदर *dūbh dāndar*, 868.
 दूर *dūr*, 1087.
 दूरा *dūra*, 1238.
 दूराब *dūhab*, 1157.
 देसही *deurhi*, 1254.
 देवता *deota*, 1455, 1456.
 देहरा *dekhra*, 1253.
 देखिहो *dekhiha*, 1091, 1113.
 देगन्ची *degchi*, 448, 711.
 देवाल *dewāl*, 233.
 देवाला *dewāla*, 1486.
 देवाली *dewāli*, 538.
 देसरिया *desariya*, 965f.
 देसिला *desila*, 956, 1073.
 देहन *dehan*, 1477.
 देहन् *dehand*, 1477.
 देहन्री *dehri*, 1238.
 देहाती *dehāti*, 1263.
 देहुरी *dehuri*, 1203.
 दे *de*, 748, 1025.
 दे के *de ke*, 69.
 देखाब *dekhāb*, 1428.
 देखर *dekhār*, 1253.
 देखल *dekhāl*, 1484.
 देखल *dekhāh*, 1113.
 देखि *dekhi*, 1070.
 देखे *dekhe*, 128 (footnote), 1087.
 देखें *dekhen*, 568.
 देग *deg*, 372, 711, 713.
 देन *den*, 1284, 1461.
 दैन मोहर *dain mohar*, 1284.
 देना *dena*, 1151.
 देब *deb*, 58, 585f, 867, 876, 966, 1087, 1090, 1116, 1385, 1416, 1419, 1423, 1429, 1431, 1439, 1452.
 देब उथान *deb uthān*, 1087, 1439.
 देबी *debi*, 1449, 1455, 1456.
 देबी अस्थान *debi asthān*, 1455.
 देबी थान *debi thān*, 1455.
 देलें *del*, 250.
 देलन्धि *delanhi*, 1234.
 देलें *deln*, 741.
 देलें *doleñ*, 1217.
 देव *deo*, 585f.
 देवठान *deothān*, 1439.
 देवाल *dewāl*, 1251.
 देस *des*, 1088, 1092.
 देसी *desi*, 328, 956, 1021, 1059.

- देही *dehi*, 973, 1207, 1215, 1218.
 देही खरन्व *dehi kharch*, 1207.
 देहाग्रव *daihäëb*, 1078.
 देना *daina*, 1151.
 दोषान्न *doät*, 1198.
 दोषान्न पुजार *doät pujäi*, 1198.
 दोषार *doär*, 1238, 1249.
 दोषाची *doäli*, 388, 398, 415.
 दोषाच *doäh*, 1278.
 दोकन्दा *dokra*, 149, 1497.
 दोकन्दा *dokra*, 1497.
 दोकान *dokän*, 463.
 दोकानो *dokäni*, 373, 933, 940, 1023.
 दोकन्ता *dokhta*, 1023.
 दोगन्ना *dogla*, 956.
 दोगचा *dogaha*, 111, 889.
 दोगाच *dogäh*, 1153, 1239.
 दोग्घान्न *doghänw*, 953.
 दोगावा *doghäwa*, 953.
 दोकन्दा *dochra*, 1235, 1245.
 दोषारा *dochära*, 1245.
 दोषपन्ना *dochhapra*, 1245.
 दोतन्ना *dotra*, 798.
 दोतन्ना चौमास *dotra chaumäs*, 798.
 दोतुरा *dotura*, 810, 1006, 1008.
 दोतुरा के जख *dotura ke ükh*, 1008.
 दोदन्त *dodant*, 1118.
 दोदन्ता *dodanta*, 1118.
 दोषरिषा *dodhariya*, 857.
 दोगन्वाच *donwäh*, 950.
 दोपन्टा *dopta*, 730, 740.
 दोपडा *dopatta*, 724, 730, 740.
 दोपतिषा *dopatiya*, 1018.
 दोपती *dopatti*, 1018.
 दोषलिषा *dopaliya*, 725, 1245.
 दोषहरिषा *dopahariya*, 837, 842.
 दोषसिद्धा *dophasila*, 803, 858.
 दोषसिद्धी *dophasili*, 803.
 दोषगन्धी *dobaghi*, 111.
 दोषग्न्यी *dobaggi*, 111.
 दोषविषा *dobadhiya*, 639.
 दोषरन्दा *dobarda*, 31, 149.
 दोषागी *dobägi*, 111.
 दोषारा *dobära*, 373.
 दोषिषा *dobiha*, 1278.
 दोमन्दा *domra*, 884.
 दोरन्वाची *dorsähi*, 787.
 दोरन्वा *dorassa*, 1023.
 दोरन्वो *dorasso*, 468, 1023.
 दोलन्गी *dolgi*, 977.
 दोलन्गी *dolangi*, 974.
 दोलन्डी *dolattähi*, 926.
 दोलार *doläi*, 731.
 दोलाच *doläy*, 876.
 दोलाच देव *doläy deb*, 876.
 दोसन्ना मन्टी के बीया *dosra mänti ke biya*, 1057.
 दोसन्ना *dosro*, 1007.
 दोसन्ना पडावन *dosro patäwan*, 1007.
 दोषलिषा *dosaliya*, 803.
 दोषाल *dosäl*, 803.
 दोसती *dosäti*, 590.
 दोसन्ता *dohäta*, 1218.
 दोसन्वा *dohäta*, 852.
 दोसन्ना *dohra*, 1250.
 दोसन्नावन *dohräwan*, 819.
 दोषान्न *dohän*, 1118.
 दोषार *dohär*, 819, 857.
 दो *do*, 817, 953.
 दोष *dokh*, 1118.
 दोष बैल *dokh bail*, 1118.
 दोषाड़ *dukhär*, 819.
 दोषार *dokhär*, 819, 820.
 दोगा *doga*, 1245.
 दोंगा *donga*, 1294.
 दोंज *donj*, 1011.
 दोंजी *donji*, 1011, 1024, 1039.
 दो ठेकका *do theüka*, 953.
 दोषा *dodha*, 984.
 दोन *don*, 950.

दोना *dona*, 721, 1405.
 दोंनी *donni*, 1405.
 दोंनी जाँकब *donni jhānkab*, 1405.
 दोनों *donon*, 1088.
 दोबर *dobar*, 1084, 1092.
 दो बाँह *do bānh*, 817.
 दोमा *doma*, 1015.
 दोरघ *doras*, 468, 787.
 दोल *dol*, 924, 929.
 दोलब *dolab*, 876.
 दोसर *dosar*, 893, 838, 1007.
 दोसर चाँतर घरब *dosar antar dharab*,
 838.
 दोसर पटावन (*or* पानी) *dosar patā-*
wan (or pāni), 1007.
 दोहट *dohat*, 1218.
 दोहद *dohad*, 1399.

दोहर *dohar*, 730.
 दो हरा *do hara*, 31.
 दौंगरी *daungri*, 184.
 दौदिवा *daudiya*, 956.
 दौग *daug*, 832, 836, 1050.
 दौगर *daungar*, 836, 1050.
 दौदी *daudi*, 956.
 दौना *dauna*, 978.
 दौना पूह *dauna phūl*, 978.
 दौनी *dauni*, 649, 887.
 दौंरद *daunrar*, 889.
 दौरा *daura*, 43, 44, 442, 949,
 1347, 1350.
 दौरा में गोर डारब *daura men gor*
dārab, 1350.
 दौरी *dauri*, 43, 44, 442, 887.
 दौंरी *daunri*, 887, 889.

॥ ध dh ॥

धकरन्होह *dhakarchhoh*, 1095.
 धकरा *dhakra*, 1183.
 धंगाग्रह *dhangāḡl*, 1079.
 धंगाठ *dhangāth*, 1079.
 धनेरु *dhanger*, 1079.
 धडाठ *dhangāth*, 1079.
 धचान *dhachān*, 363 (14).
 धचाना *dhachāna*, 363 (14).
 धंधारी *dhandhāri*, 756.
 धन *dhan*, 1092.
 धनकियारा *dhankiyāra*, 981.
 धनकियारी *dhankiyāri*, 812.
 धनकुटी *dhankutti*, 616.
 धनखर *dhankhar*, 812, 981.
 धनखेत *dhankhet*, 981.
 धनखेती *dhankheti*, 981.
 धनपुरही *dhanpurahi*, 1114.
 धनबही *dhanbatti*, 1303, 1309, 1313.
 धनबाह *dhanbāl*, 984.

धनखर *dhanhar*, 812, 981.
 धनखरा *dhanahra*, 984.
 धनखा *dhanha*, 981, 1089.
 धनिचाँ *dhanichān*, 1073.
 धनिष्ठा *dhanishtha*, 1082.
 धनी *dhani*, 1461.
 धनीवा *dhanwa*, 975.
 धनुही *dhanuhi*, 334, 478.
 धनहारी *dhanhāri*, 756, 769.
 धमाका *dhamāka*, 213, 224.
 धमाकुल *dhamākul*, 1021.
 धरखा *dharkha*, 1253.
 धरजी *dharanjī*, 864.
 धरती *dharti*, 1433.
 धरती मार *dharti māi*, 1433.
 धरम *dharan*, 322, 1256.
 धरना *dharna*, 939.
 धरब *dharab*, 838.
 धरम *dharm*, 1446.

- धरमनाथ *dharmnāth*, 1456.
 धरम लगी *dharm laggi*, 328.
 धरमा *dharma*, 1446.
 धरल *dharal*, 817.
 धरहर *dharhar*, 1234.
 धरिया *dhariya*, 12, 726, 857.
 धरियाप्रब *dhariyāḥ*, 857.
 धरिष *dharis*, 1004.
 धरेवान *dhareḥo*, 817.
 धवर *dhawar*, 1134.
 धसना *dhasna*, 789.
 धाकर *dhakar*, 1095.
 धाध *dhād*, 1080.
 धान *dhān*, 963, 964, 967, 1084,
 1086, 1087, 1088, 1090, 1091,
 1217, 1303.
 धाप *dhāp*, 1492.
 धामा *dhāma*, 44.
 धार *dhār*, 25, 29, 892, 1451.
 धार अरनाप्रब *dhār asrāḥ*, 25.
 धारनिक *dhārnik*, 1461.
 धार पजाव *dhār pajāo*, 25.
 धार पिजाव *dhār pijāwal*, 25.
 धार पिटाव *dhār pitāwal*, 25.
 धार फरगाव *dhār phargāwal*, 25.
 धार बनाप्रब *dhār banāḥ*, 25.
 धारा *dhāra*, 643, 975, 1484, 1500.
 धारा करब *dhāra karab*, 1484.
 धारी *dhāri*, 835, 857.
 धारी लगाप्रब *dhāri lagaḥ*, 857.
 धावर *dhāwar*, 1134.
 धिंगान *dhingān*, 1201.
 धिमोर *dhimoi*, 1183.
 धिया *dhiya*, 990.
 धी *dhi*, 1295.
 धुवा *dhua*, 67, 68.
 धुवाकस *dhuānkas*, 302.
 धुवाँर *dhuwāñr*, 1272.
 धुंधुका *dhundhuka*, 302.
 धुनकी *dhunki*, 334.
 धुनकठ *dhunhath*, 334.
 धुमिया *dhuniya*, 334, 990.
 धुमियाँ *dhuniyān*, 476.
 धुनेठी *dhunethi*, 334.
 धुनेठ *dhunaiḥ*, 334.
 धुपदान *dhupdān*, 779.
 धुपदानो *dhupdāni*, 779.
 धुपहरा *dhupahra*, 779.
 धुपेड़ी *dhuperi*, 779.
 धुरई *dhurai*, 933, 940.
 धुरकमिया *dhurkamiya*, 303.
 धुरकिली *dhurkili*, 164, 203.
 धुरगोलो *dhurgolo*, 1135.
 धुरगुसा *dhurgussa*, 858.
 धुरकक *dhurchhak*, 1320.
 धुरपा *dhurpa*, 1075.
 धुरही *dhurhi*, 931, 940.
 धुरिया *dhuriya*, 149, 858, 914, 1096.
 धुरिया बावग *dhuriya bāwag*, 858.
 धुरप *dhurup*, 1075.
 धुरौती *dhurauti*, 174, 175.
 धुसरा *dhusra*, 967g.
 धुसरी *dhusri*, 965a.
 धुसा *dhusa*, 737.
 धू *dhu*, 868.
 धूवा *dhūa*, 1317, 1320.
 धूँ *dhūi*, 489.
 धूँध *dhūndh*, 1080.
 धून *dhūn*, 1080.
 धूनब *dhūnab*, 334.
 धूप *dhūp*, 1419.
 धूमन *dhūman*, 347.
 धूर *dhūr*, 833, 851, 1094, 1096,
 1495.
 धूर बाँगर *dhūr bāngar*, 1094.
 धूरा *dhūra*, 166, 203, 221, 489.
 धूरी *dhūri*, 149, 166, 221, 414,
 1096.
 धूस *dhūs*, 737, 785.
 धूसी *dhūsi*, 785.

दूध *dhūh*, 67.
 दूधा *dhūha*, 67.
 धेनुवागर *dhenuāgar*, 1164.
 धेनुन *dheñn*, 1114.
 धेन *dhen*, 1114, 1158.
 धेन के दूध *dhen ke dūdh*, 1158.
 धेनु *dhenu*, 1114.
 धै *dhai*, 1451.
 धै चावल *dhai āwal*, 69.
 धोआँच *dhoāñch*, 1272.
 धोरहें *dhoihēn*, 1092.
 धोकड़ा *dhokra*, 719.
 धोकड़ें *dhokren*, 719.
 धोकरी *dhokri*, 734.
 धोबडाँग *dhobdāng*, 390.
 धोबिनिषाँ *dhobiniyāñ*, 740.
 धोबिषा *dhobiya*, 393.
 धोरखा *dhorkha*, 1253.
 धोरेषा *dhorea*, 933, 940.
 धोषल *dhoan*, 1032.

धोषल *dhoal*, 1272.
 धोषल दाँल *dhoal dal*, 1272.
 धोषा *dhoa*, 542.
 धोरे *dhoi*, 1341.
 धोरे *dhoi*, 1032, 1272, 1369.
 धोराँल *dhoel*, 391.
 धोरे *dhoe*, 1032.
 धोकर *dhokar*, 1458.
 धोकर कसवा *dhokar kaswa*, 1458.
 धोंग *dhong*, 1272.
 धोंच *dhonchh*, 1117.
 धोती *dhoti*, 726, 740, 1357.
 धोषर *dhodhar*, 920c.
 धोंधा *dhondha*, 466, 1251.
 धोबिक *dhobik*, 393.
 धोबी *dhobi*, 389, 393, 1092, 1204.
 धोकनी *dhaukni*, 510.
 धौरहर *dhaurahar*, 1234.
 धौना *dhauna*, 500.
 धौर *dhaul*, 1134.

॥ न n ॥

ना *na*, 128, 226, 394, 572, 1026,
 1056, 1084, 1085, 1087, 1234.
 नाई *nai*, 740.
 नाकचन्दा *nakchanda*, 763.
 नाकखिकनी *nakchhikni*, 1075.
 नाकती *nakti*, 20.
 नाकपाँचे *nakpāñche*, 1445.
 नाकपाँचो *nakpāñcho*, 971.
 नाकरई *nakrai*, 1474.
 नाकरई सकरई *nakrai sakrai*, 1474.
 नाकसोंध *naksondh*, 1146.
 नाकादर *nakādar*, 1094.
 नाकलोल *naklol*, 114.
 नाकेल *nakel*, 114, 1131.
 नाकैल *nakail*, 114.
 नाकत *nakhat*, 971, 1082.
 नांगड़ा *nangra*, 301.

नागद *nagad*, 1488.
 नागदा *nagda*, 1488.
 नागदा नागदी *nagda nagdi*, 1488.
 नागदी *nagdi*, 902, 1198, 1221,
 1225, 1488.
 नागपाँचे *nagpāñche*, 1445.
 नागर *nagar*, 1416.
 नागर बिसर्राँच *nagar bisrāñch*, 1416.
 नागर मोथा *nagar motha*, 1381.
 नागला *nagla*, 226.
 नांगोट *nangot*, 726.
 नांगोटा *nangota*, 726.
 नाघुरी *naghuri*, 768.
 नाङ्गर *nanagar*, 1130.
 नाचनी *nachni*, 363 (13).
 नाचहर *nachhatr*, 967, 1082.
 नाकुनाप *nachhunāe*, 1326.

- नजर *najar*, 69, 813.
 नजर गुजर *najar gujar*, 69.
 नजर गोजर *najar gojar*, 69.
 नजर बाग *najar bag*, 813.
 नजराणा *najrana*, 1201.
 नटगात्र *natbāj*, 585 (*f*).
 नटगा *natua*, 353, 501, 1099.
 नटार *natāi*, 501.
 नटुषा *natua*, 1154, 1358.
 नट्टि *natthahi*, 1084.
 नठहार *nathahar*, 1117.
 नत्तो *natti*, 353.
 नथ *nath*, 763.
 नथिया *nathiya* 236, 763, 936.
 नथिवारी *nathiyāri*, 936.
 नथुनी *nathuni*, 763.
 नदगा *nadua*, 308.
 नदगा *nadha*, 365.
 नदिया *nadiya*, 138, 139, 713, 1088.
 नदी *nadi*, 655.
 नदोद *nadoi*, 141, 713, 719.
 नदी *naddi*, 916, 954.
 नधगा *nadhna*, 276.
 नधान *nadhān*, 116, 276.
 ननकटनी *nankatni*, 875.
 ननकिरवा *nankirwa*, 1099.
 ननद *nanad*, 1402.
 ननगार *nanbāi*, 445.
 ननमुषिया *nanmuhiya*, 499.
 ननिचौरा *naniaura*, 1298.
 ननिहर *nanihar*, 1298.
 ननिहार *nanihār*, 1298.
 ननिहाल *nanihal*, 1298.
 ननकटनी *nanhkatni*, 875.
 ननिहा *nanhiya*, 972, 985.
 ननिहा जनेरा *nanhiya janera*, 985.
 नपची *naphi*, 378.
 नपाळी *naphāi*, 1057.
 नपार *naphar*, 844.
 नफा *napha*, 1475.
 नबग्रह *nabgrah*, 767.
 नबात *nabāt*, 1389, 1390.
 नबात चुनब *nabāt chūnab*, 1389, 1390.
 नबेर *naber*, 419.
 नबेरी *naberi*, 419.
 नमेर *namer*, 419.
 नमेर *namher*, 861.
 नमेरो *namhero*, 861.
 नया *naya*, 740.
 नर *nar*, 381, 472, 978, 1026, 1034.
 नरकट *narkat*, 815.
 नरकटार *narkatāi*, 1400.
 नरकटिया *narkatiya*, 985.
 नरकान *narkān*, 815.
 नरगोरी *nargori*, 1005.
 नरगा *naroha*, 1034, 1183.
 नरगा *narja*, 462.
 नरगौक *narjonk*, 1183.
 नरदोह *nardoh*, 270.
 नरपुर *narpur*, 1025.
 नरम *naram*, 786.
 नरमा *narma*, 1016.
 नरहानी *narhanni*, 1030.
 नरही *narhi*, 1257.
 नरहु *narhu*, 996.
 नरहो *narho*, 996.
 नराड *narāūn*, 510.
 नरियार *nariyar*, 472.
 नरियारवाला *nariyarwāla*, 471.
 नरियारी *nariyari*, 715.
 नरिया *nariya*, 75, 713, 1262.
 नरियाल *nariyāl*, 472.
 नरी *nari*, 363, 529, 567, 570.
 नरुवा *narua*, 990, 1183.
 नरे *narai*, 1183.
 नरैली *naraili*, 17.
 नरोद *naroi*, 814.

नरोई *naroīn*, 814.
 नरोह *naroh*, 253, 270.
 नरोही *narohi*, 270.
 नरोषा *naraua*, 510, 545.
 नख *nal*, 381.
 नखा *nalla*, 585.
 नव *naw*, 814.
 नव गच्छी *naw gachhūi*, 814.
 नवगहर *nawghar*, 2, 29.
 नवगठा *nawtha*, 2, 825.
 नवगठा के जोत *nawtha ke jot*, 825.
 नवत *nawat*, 1344.
 नवना *nawta*, 645.
 नव पेड़ा *naw pera*, 814.
 नवहरा, *nawahra*, 825.
 नवाद *nawād*, 981.
 नवाद खेत *nawād khet*, 981.
 नविशतखामी *nawishtakhāmi*, 1040.
 नस *nas*, 1023.
 नस *nah*, 153, 1349.
 नसकटिया *nahkatiya*, 1326.
 नस चहार *nah chhachhāi*, 1349.
 नसकुषा *nahchhua*, 1326.
 नसकुषा नखावन *nahchhua nahāwan*, 1326.
 नसख *nahchhu*, 1313, 1314, 1326.
 नसखुङ्गी *nahtungī*, 1326, 1403, 1411.
 नसर *nahar*, 916.
 नसरन *nahrān*, 383.
 नसरनी *naharni*, 383, 470, 1030.
 नसखला *nahla*, 422.
 नसवाप *nahwāp*, 1418.
 नस *nahas*, 1454.
 नसार *nahāi*, 526.
 नखावन *nahāwan*, 1326, 1402.
 नहिं *nahīn*, 235, 250, 363, 393, 548, 990, 1088, 1090, 1272.
 नहिरा *nahira*, 1297.
 नहो *nahīn*, 29.

नहेरि *naheri*, 383.
 ना *na*, 356, 1020, 1090, 1284, 1451, 1477.
 नास *nāu*, 383.
 नाप्रक *nāek*, 1456.
 नाप्रक साहेब *nāek saheb*, 1456.
 नाचो *nāo*, 1088.
 नाक *nāk*, 346.
 नाग *nāg*, 1445, 1456.
 नाँगनो *nāngno*, 7.
 नाग पंचमी *nāg panchmi*, 1445.
 नागपुर *nāgpur*, 1025.
 नागखला *nāgla*, 226.
 नागिन *nāgin*, 1456.
 नाटा *nāta*, 149, 261, 1096, 1099.
 नाटा बैल *nāta bail*, 261.
 नाठा *nātha*, 1157.
 नाड़ा *nāra*, 1381, 1384, 1391.
 नाड़ा *nārha*, 1109.
 नाथ *nāth*, 112, 261, 1234.
 नाद *nād*, 92, 284, 309, 365, 430, 506, 713, 924.
 नाँद *nānd*, 92, 314, 816, 430.
 नादा *nāda*, 365.
 नादी *nādi*, 304, 1173.
 नादी बनवा *nādi kanwa*, 1173.
 ना देहन *na dehan*, 1477.
 ना देहन् *na dehand*, 1477.
 नाध *nādh*, 276.
 नाधन *nādhan*, 258, 276.
 नाधव *nādhav*, 817.
 नाध बरना *nādh barta*, 276.
 नाधा *nādha*, 17, 116, 277, 930.
 नाधा बरना *nādha barta*, 279.
 नानपज *nānpaj*, 445.
 नानवार *nānbāi*, 445.
 नानीवाल *nānihāl*, 1298.
 नाप *nāp*, 1028.
 नापा *nāpa*, 378.
 नापी *nāpi*, 1028.

- नाफा *nāpha*, 1475.
 नाव *nāb*, 75.
 नापूर *nāpūr*, 912, 1230.
 नाम *nām*, 1463a, 1485.
 नाम घेरुद गैल *nām gheral gail*, 1485.
 नामजद *nāmjad*, 1486.
 नामा *nāma*, 1488.
 नार *nār*, 75, 80, 90, 655, 894, 990,
 1183, 1259, 1400, 1401, 1408.
 नारकटाई *nārkatāi*, 1400.
 नारगी *nārgi*, 318.
 नारजी *nāranji*, 1043.
 नारन *nāran*, 17, 277.
 नार पुरैव *nār purain*, 1401.
 नारा *nāra*, 743, 990, 1183.
 नारी *nāri*, 90, 315, 529, 570, 798,
 836, 954, 1006, 1008.
 नारी के अक्ष *nāri ke akh*, 1008.
 नरैनी *nāraini*, 1429.
 नास *nāl*, 585.
 नासकी *nālki*, 241.
 नासबन्द *nālsband*, 387.
 नासा *nāla*, 792.
 नासी *nāli*, 315, 532.
 नाव *nāw*, 229.
 नाँव *nānw*, 1463a and b.
 नाशन्ता *nāshṭa*, 1268.
 नास *nās*, 9, 1023.
 नास पाल *nās pāl*, 585.
 नासा *nāsa*, 9.
 नाह *nāh*, 153.
 नाहा *nāha*, 153.
 नाहक *nāhak*, 356.
 नाहीं *nāhīn*, 829, 964, 1084, 1091.
 निकसब *niksab*, 1486.
 निकसार *niksār*, 1249.
 निकसारी *niksāri*, 1175.
 निकसब *nikaēb*, 867.
 निकाल *nikāla*, 1085.
 निकवान *nikāwan*, 867.
 निकास *nikās*, 1249.
 निकासब *nikāsab*, 1486.
 निकासल *nikāsāl*, 1098.
 निकाह *nikāh*, 1273, 1279, 1382.
 निकौरिया *nikauriya*, 1070.
 निकौनी *nikāuni*, 865, 869.
 निकी *nikti*, 644.
 निहार *nikhārā*, 391.
 निखुराह *nikhurāh*, 1146.
 निहोराह *nikhorāh*, 1146.
 निंगछा *ningchha*, 1457.
 निंगछा शेरी *ningchha chhori*, 1457.
 निगरेन *nigrān*, 954.
 निगसा *nigasta*, 1258.
 निगासी *nigāli*, 472, 1034.
 निगिहरी *nigihri*, 768.
 निघास *nighās*, 896, 983, 1145.
 निघेस *nighes*, 896, 1079.
 निघेसा *nighesa*, 983.
 निचिन *nichint*, 572.
 निचिराकी *nichirāki*, 796.
 निचहर *nichhatr*, 1082.
 निचरब *nichharab*, 391.
 निचावर *nichhāūr*, 1347.
 निचावर *nichhāwar*, 1347, 1402.
 निचावर करब *nichhāwar karab*, 1402.
 निची *nitti*, 644.
 निदान *nidān*, 1085.
 निपनियाँ *nipaniyān*, 801.
 निबन्दा *nibra*, 319i.
 निबद्द *nibaddar*, 1091.
 निमक *nimak*, 1407.
 निमक चसी *nimak chasi*, 1407.
 निमनीरिद *ningirid*, 403, 418.
 निमन्ददा *nimdanda*, 228.
 निमन्दा *nimra*, 319i.
 निमन्ददा *nimdāsta*, 706.
 निमाद्द *nimār*, 392.
 निमारा *nimāra*, 154.
 निमासीन *nimāstin*, 729.

निषाज *niyāj*, 1408, 1414.
 निषाज करव *niyāj karab*, 1408.
 निषारिषा *niyariya*, 542.
 निषार *niyār*, 542.
 निषार घोषा *niyār dhoa*, 542.
 निषारा *niyāra*, 543.
 निषारिषा *niyāriya*, 542.
 निरक *nirakh*, 1488.
 निरक नामा *nirakh nāma*, 1488.
 निरच्छन *nirachchhan*, 1322.
 निरच्छन *nirchhan*, 1322.
 निरन्वीज *nirbīj*, 859.
 निरम्मस *nirmal*, 1091.
 निरारी *nirāri*, 939.
 निरिच्छन *nirichchhan*, 1322.
 निरेखव *nirekhab*, 1322.
 निरोह *niroh*, 251, 253, 270.
 निर्विज्ज *nirbīj*, 1078.
 निर्वीज *nirbīj*, 1078.
 निशःकरन्दा *nishkarda*, 587.
 निसन्वत *nisbat*, 1285, 1364.
 निसुषा *nisua*, 286.
 निसुषा *nisuha*, 91, 286.
 निस्तार *nistar*, 427.
 निहार *nihāi*, 408, 526, 539, 549.
 नीच *nich*, 1217.
 नीपे *nipe*, 1267.
 नीम, *nim*, 1402.
 नीम दूरी *nim dhūri*, 154.
 नीमन *niman*, 741.
 नीमा *nima*, 729, 1074.
 नील *nil*, 1038.
 नुङ्गा *nūnga*, 723.
 नुष्ठा *nūṣṭha*, 710.
 नूगा *nūga*, 723, 740.
 नूंगा *nūnga*, 723.
 नून्दा *nūnda*, 121, 710.
 नूरो *nūro*, 710.
 नेषरन्धरशा *neardharua*, 1292.
 नेषार *neār*, 1292, 1349.

नेषारा *neāra*, 543.
 नेमन्दा *nengra*, 302.
 नेटवा *netwa*, 501.
 नेटुषा *netua*, 652, 1154.
 नेनुषाँ *nenuān*, 1069.
 नेवान *nebān*, 877.
 नेवारा *nebāra*, 154.
 नेमान *nemān*, 1090, 1438.
 नेवशा *nerua*, 990.
 नेवन्हावर *newchhāwar*, 1347.
 नेवन्तहार *newtahar*, 1292.
 नेवन्ता *newta*, 145, 645, 1426, 1344.
 नेवन्ता *neṅta*, 1344.
 नेवन्त *newnath*, 389.
 नेवान *newān*, 877, 1438.
 नेवानी *newāni*, 1438.
 नेवार *newār*, 1073.
 नेवारी *newāri*, 894, 1183.
 नेवाला *newāla*, 1271.
 नेवनी *nehni*, 470, 512, 555.
 नेवन्रा *nehra*, 1297.
 नेहार *nehāi*, 408.
 नेहारक *nehāik*, 408.
 नेहाए *nehāē*, 526, 549.
 नेहाय *nehay*, 560.
 नेहाली *nehāli*, 731.
 नेउन *neun*, 1160, 1166.
 नेकी बीबी *neki bibi*, 1458.
 नेग *neg*, 912, 1198, 1400.
 नेठो *netho*, 652.
 नेहा *nerha*, 984.
 नेहा *nenrha*, 1074.
 नेत *net*, 145.
 नेतो *neto*, 145.
 नेन *nen*, 1166.
 नेनु *nenu*, 1160, 1166.
 नेफा *nepha*, 743.
 नेव *neo*, 1251.
 नेवत *newat*, 145, 645.
 नेवन्तैतिव *nehraitin*, 1277.

नेचा *naicha*, 473.
 नेचाबन *naichāban*, 474.
 नेचाबन्ध *naichaband*, 474.
 नेजा *naija*, 1376.
 नेनू *nainu*, 1160.
 नेया *naiya*, 229.
 नेहर *naihar*, 1297.
 नोकन्ता *nokta*, 97.
 नोचिया *nochiya*, 1198.
 नोचन्हराह *nonchharah*, 816.
 नोनिथा *noniya*, 713.
 नोनिथी *noniyān*, 365, 1431.
 नोनिथारी *noniyāri*, 816.
 नोनिथाह *noniyāh*, 816.
 नोह *noh*, 1349.
 नोह चिखार *noh chhilāi*, 1349.
 नोहण्टुंगार *nohtungāi*, 1403.
 नोहण्टुंगी *nohtungi*, 1403.
 नोकर *nokar*, 740, 844, 1184.
 नोचा *noncha*, 1198, 1200.
 नोचे *noche*, 356.

नोमी *nomi*, 816, 1003.
 नोमी चारी *nomihari*, 44.
 नोमेका बनेचा *naukera bagaicha*, 814.
 नोखीह *naukhih*, 981.
 नोगाही *naugāchhi*, 814.
 नौराही *naurāhi*, 814.
 नोसत्ता *nausatta*, 905, 906.
 नोह दिछी *nauh chhilli*, 1349.
 नौ *nau*, 363, 741, 975, 1070, 1127.
 नौचा *naua*, 383, 1204, 1286.
 नौचा ब्राह्मण *naua brāhman*, 1286.
 नौठ *nauthat*, 1246.
 नौठ कर *nauthat karab*, 1246.
 नौठा *nautha*, 2.
 नौ चारा *nau dhāra*, 975.
 नौनगा *naunaga*, 767.
 नौपचम *naupancham*, 1236.
 नौरतन *nauratan*, 1236.
 नौसे *naushe*, 1281.
 नौसत *nausat*, 905, 906.

॥ प p ॥

परसा *paīla*, 24.
 परै *pai*, 1017.
 पप्रना *paēna*, 98.
 पप्रसा *paēla*, 24.
 पकण्डारह *pakthāil*, 984.
 पकण्टा *pakarta*,
 पकड़ि *pakari*, 568.
 पकण्मान *pakmān*, 1272.
 पकण्वान *pakwān*, 1272.
 पकण्वाह *pakwāh*, 293.
 पकण्जी *paksi*, 375.
 पंकाहा *pankha*, 789.
 पकुषा *pakua*, 1023.
 पकुसी *pakusi*, 375.
 पका *pakka*, 920, 1235, 1263, 1495.
 पका पिगन्हा *pakka bigha*, 1495.
 पकखन *pakghan*, 1074.
 पकखी *pakghi*, 1074.

पक *pakh*, 1081, 1088.
 पंखण्डी *pankhi*, 414.
 पकखरी *pakhnari*, 363.
 पकखनी *pakhni*, 898.
 पकखीर *pakhbir*, 363.
 पकखरा *pakharua*, 1341.
 पखारी *pakhāri*, 1341.
 पखिया *pakhiya*, 1074.
 पखुरी *pakhuri*, 543.
 पखेचार *pakheār*, 363.
 पखेव *pakheo*, 1119.
 पखेवा *pakhewa*, 1119.
 पगण्डा *pagra*, 120, 533, 1010, 1012.
 पगण्डी *pagri*, 533, 724, 912, 1426.
 पगण्डी ठसा *pagri thasa*, 533.
 पगण्डी बन्हाप्रव *pagri banhdēb*, 1426.
 पगरन्वाह *pagarwāh*, 292.
 पंगरन्वाह *pagarwāh*, 292.

पगघा *pagha*, 108, 261, 1234.
 पगरी *pagri*, 724.
 पगार *pagār*, 1010, 1012.
 पगिया *pagiya*, 724.
 पगुरी *paguri*, 1011.
 पगुरी *paguri*, 1143.
 पगुरी करब *paguri karab*, 1148.
 पंगौरा *pangaura*, 308.
 पघरिया *paghariya*, 73.
 पघरया *pagharua*, 73.
 पघुराएब *paghurāeb*, 1143.
 पघुरी *paghuri*, 1143.
 पघुरी करब *paghuri karab*, 1143.
 पङ्क *pank*, 788, 789.
 पङ्का *pankha*, 414, 529.
 पङ्गी *pankhi*, 225, 414, 529, 975, 1256.
 पङ्गत *pangat*, 1450.
 पङ्घत *panghat*, 1341.
 पंचचगिन *panchagin*, 1419.
 पंचचणी *panchanni*, 1479.
 पंचचानि *panchāgi*, 1419.
 पंचकुच *panchukh*, 1437.
 पंचकटेल *panchkatail*, 787.
 पंचकटा *panchkatta*, 1074.
 पंचकठिया *panchkathiya*, 348, 1419.
 पंचकरमा *panchkarma*, 1419.
 पंचका *pankha*, 1428.
 पंचकाठ *panchkāth*, 1419.
 पंचकाठी *panchkāthi*, 1419.
 पंचकखी *panchkhandi*, 768.
 पंचका *pankha*, 76.
 पंचकाँड़ *pankhhānr*, 1437.
 पंचकी *pankhi*, 1024.
 पंचगोठिया *panchgotiya*, 984.
 पंचघन *panchghan*, 1439.
 पंचगुरी *panchri*, 11, 401.
 पंचदू *panchdu*, 908.
 पंचदू *panchdu*, 908, 909.
 पंचनी *panchni*, 319i.

पंचपातर *panchpātar*, 775.
 पंचपिंडा *panchpinda*, 1421.
 पंचपिरिया *panchpiriya*, 1456.
 पंचपरिया *panchphariya*, 37.
 पंचमंगरा *panchmangra*, 1305.
 पंचरावन *panchrāwan*, 1194.
 पंचरी *panchri*, 331.
 पंचरुखी *panchrūkhi*, 956.
 पंचरुखी *panchrūkhi*, 585.
 पंचलकटा *panchlakra*, 172.
 पंचलकट्टी *panchlakri*, 1419.
 पंचलरी *panchlari*, 765.
 पंचलती *panchlati*, 737.
 पंचारठ *panchāth*, 1435.
 पंचारत *panchāt*, 1450.
 पंचारत सेँ काठ देब *panchāt señ kat deb*, 1452.
 पंचाँटी *panchānti*, 1435.
 पचाड़ *panchār*, 1114.
 पचार *panchār*, 938.
 पचास *panchās*, 823.
 पंचौत *panchit*, 1450.
 पचे *panche*, 1272.
 पंचेता *pancheta*, 1450.
 पंचेती *panchaiti*, 1450.
 पचौआँ *panchāuān*, 801.
 पंचौक *panchāukh*, 1437.
 पंचौट *panchaut*, 831.
 पचड़ *panchchar* 164, 157, 401.
 पचर *panchchar*, 157, 179.
 पचा *panchcha*, 908.
 पचा दुचा *panchcha dūa*, 908.
 पची *panchchi*, 157, 401, 485.
 पच *panchchh*, 1081.
 पचकी *panchhki*, 1011.
 पचनिहार *panchnihār*, 1030.
 पचनिहारिन *panchnihārin*, 1030.
 पचलकटा *panchlakra*, 172.
 पचलकटा *panchlagwa*, 1279.
 पचवा *panchhwa*, 1087, 1088.

पचहर *pachhahar*, 614.
 पचाह *pachhār*, 113, 614, 932.
 पचाही *pachhāri*, 366.
 पचिमा *pachhima*, 1088.
 पचिबारी *pachhiyāri*, 1005.
 पचुचा *pachhua*, 181, 558, 614, 726,
 900, 912, 914, 1483.
 पचुचार *pachhuār*, 1237
 पचुचारा *pachhuāra*, 1237.
 पचुत *pachhūt*, 1245.
 पचुत के ठाट *pachhūt ke thāt*, 1245.
 पचेचा *pachhea*, 1087, 1092.
 पचेहुन्ना *pachherna*, 172.
 पचेहिचा *pachheliya*, 768.
 पचेह *pachher*, 932.
 पचेहा *pachhela*, 363, 558, 768.
 पचोही *pachhohi*, 125.
 पचौटा *pachhauta*, 335e.
 पचौरा *pachhaura*, 614.
 पंचनी *panjani*, 168, 203.
 पञ्जाबा *pajwāba*, 292.
 पजार *pajāi*, 1263.
 पजावा *pajāwa*, 1264.
 पञ्जिबार *panjiyār*, 1354.
 पञ्जौर *panjaur*, 1194.
 पञ्जौरा *panjaura*, 1196.
 पचक *ponchak*, 1428.
 पचमी *panchami*, 1445.
 पच्चा *panya*, 274.
 पठ *pat*, 843.
 पठकन *patkan*, 477, 654.
 पठकी *patki*, 1004.
 पठदेहर *patdehar*, 1251
 पठदेहल *patdehal*, 1251.
 पठना *patna*, 625, 1486.
 पठपर *patpar*, 788, 901.
 पठपरी *patpari*, 793.
 पठमौरी *patmauri*, 1326.
 पठरा *patra*, 222, 414, 457, 467,
 635.

पठराही *patrāhi*, 1001.
 पठरी *patri*, 248, 587, 600, 768,
 1262.
 पठल *patal*, 878.
 पठवडन *patwatan*, 233, 367.
 पठवा *patwa*, 496, 768.
 पठवार *patwār*, 236.
 पठवारी *patwāri*, 1198.
 पठवाही *patwāhi*, 1326.
 पठवे *patwe*, 30.
 पठवा *patha*, 389.
 पठुआ *patahuā*, 801, 1240.
 पठुऐरा *pathera*, 496.
 पठुऐरी *patheri*, 496.
 पठा *pata*, 1001.
 पठार *patāi*, 233.
 पठाप्र *patāēb*, 915, 1006.
 पठाप्रल *patāēl*, 850, 1001.
 पठाचोल *patāōl*, 801.
 पठाखा *patākha*, 585f.
 पठाही *patārhi*, 1074.
 पठान *patān*, 915.
 पठा लागत वा *pata lāgat vā*, 1001.
 पठावन *patāwan*, 915, 1006, 1007.
 पठिदार *patidār*, 1214.
 पठिदारी *patidāri*, 1214.
 पठिबा *patiya*, 213, 248, 467, 738,
 889, 1265.
 पठिहर *patihar*, 915.
 पठील सोज *patil soj*, 711.
 पठुवा *patua*, 1047, 1073.
 पठेबाज *patēbāj*, 585f.
 पठेर *pater*, 815.
 पठेही *patēhi*, 230.
 पठेवारी *patēwāri*, 1468b.
 पठेही *patāhi*, 230, 233.
 पठोर *patōi*, 1074.
 पठोतन *patotan*, 1262.
 पठोवा *patāua*, 801, 1039, 1210,
 1482.

- पडौंवा *patauhāñ*, 1210.
 पडौरे *pataui*, 801.
 पडौना *patauna*, 801.
 पडौनी *patauni*, 915.
 पडौरी *patauri*, 233.
 पडा *patta*, 11, 128, 213, 317, 574, 1471.
 पडो *patti*, 213, 243, 502, 638, 748, 1214.
 पडा *pattha*, 1125, 1129.
 पठरा *pathra*, 1125.
 पठरु *pathru*, 1122, 1123.
 पठरुनिवा *pathruniya*, 1295.
 पठिवा *pathiya*, 889, 1122.
 पडुबन्धि *parruhi*, 1120.
 पडुब *parru*, 1120.
 पडाक *parāk*, 170, 172.
 पडाका *parāka*, 585f.
 पडे *pare*, 393.
 पडिवा *parhiya*, 745.
 पण्डित *pandit*, 572.
 पतरे *patai*, 1010.
 पतकडा *patkatta*, 1074.
 पतनारी *patnāri*, 271.
 पतनी *patni*, 880, 1211.
 पतनीदार *patnidār*, 1211.
 पतन *patr*, 1085, 1343.
 पतरुपारा *patarpāra*, 292.
 पतरुस *patras*, 1010.
 पतरी *patri*, 721, 1343, 1487.
 पतरौरी *patrauri*, 721.
 पतल्लुवा *patlagua*, 1004.
 पतल्लु *patlaggu*, 1004.
 पतला *patla*, 136, 858.
 पतल्लार *patlār*, 1183.
 पतलो *patlo*, 1010.
 पतवार *patwār*, 236.
 पतवर *pathar*, 120, 1010.
 पतहु *pathūl*, 1010.
 पतहो *pathol*, 1010.
 पता *pata*, 1024.
 पता तुर *pata tūrab*, 1024.
 पतारा *patāra*, 1457.
 पताल *patāl*, 1101.
 पताल सिङ्गी *patāl singhi*, 1101.
 पताली *patāli*, 1101, 1113.
 पतिवा *patiya*, 1018.
 पतिवाग्रह *patiyāḥl*, 1018.
 पतियार *patiyār*, 236.
 पंतियारी *pantiyāri*, 814.
 पतिली *patili*, 668.
 पती *pati*, 1274.
 पतिल *patil*, 858.
 पतीला *patila*, 711, 713.
 पतीली *patili*, 448, 711.
 पतुकी *patuki*, 139, 713.
 पतेन *patain*, 235, 1010.
 पतौड़ी *patauri*, 880.
 पतौतन *patautan*, 1210.
 पतौर *pataur*, 873, 880.
 पतौरा *pataura*, 984, 1010, 1073, 1272.
 पतन *pattan*, 880.
 पतार *pattar*, 178, 268.
 पतल *pattal*, 721, 1029, 1422.
 पता *patta*, 21, 404, 721, 764, 1462.
 पत्ती *patti*, 425.
 पत्तर *patthar*, 565, 593, 1080, 1265.
 पत्तल *patthal*, 404, 565, 1080, 1265.
 पत्र *patra*, 1354.
 पत्री *patri*, 1344, 1487.
 पथरुडिवा *pathratiya*, 786.
 पथरी *pathri*, 565.
 पथरेहर *pathrehar*, 794.
 पथरौठी *pathrauti*, 769, 786, 794.
 पथरौर *pathraur*, 853.
 पथल *pathal*, 318, 389, 404, 549, 1087.
 पथाना *pathāna*, 638.
 पथार *pathār*, 832.

पथारी *pathāri*, 853, 880.
 पथिया *pathiya*, 39, 43, 93, 288.
 पथुषा *pathua*, 1262.
 पथुली *pathuli*, 44.
 पथौनी *pathauni*, 638.
 पदुका *paduka*, 585.
 पंदेनी *pandeni*, 551.
 पन *pan*, 854.
 पनकाठी *pankāthi*, 551.
 पनकी *panki*, 854.
 पनगाथा *panganda*, 1007.
 पनगिजा *panginja*, 1263.
 पनचठी *pancharhi*, 1287.
 पनचाहा *panchāha*, 419.
 पनचोरा *panchora*, 713.
 पनचणी *panchhatti*, 1245.
 पनचण्डा *panchhanda*, 915.
 पनचण्डा *panchhanna*, 915, 945.
 पनचाही *panchhāhi*, 1005.
 पनचोर *panchhor*, 115, 116, 930.
 पनचोकी *panchoki*, 1287.
 पनचडिषा *pandathiya*, 1021.
 पनचूबी *pandūbi*, 1458.
 पनदान *pandān*, 708.
 पनपिचौषा *panpiaua*, 884.
 पनपिचार *panpiyāi*, 1268.
 पनपिचार *panpiyār*, 1268.
 पनपिचाव *panpiyādo*, 1268.
 पनबहा *panbatta*, 660, 708, 711.
 पनबही *panbatti*, 660, 1285.
 पनभरा *panbhara*, 915.
 पनभारा *panbhāra*, 915.
 पनभार *panmār*, 769.
 पनभारा *panmāra*, 721.
 पनभोरवाच *panmorwāh*, 915.
 पनभोरा *panmora*, 945.
 पनवा *panwa*, 767.
 पनवाळा *panwāla*, 553.
 पनसचा *pansacha*, 923.
 पनसारी *pansāri*, 966a, 1005.

पनवाहा *pansaha*, 969.
 पनवाही *ansāhi*, 1005.
 पनसुही *pansūhi*, 231.
 पनसेरा *pansera*, 1500.
 पनसेरी *panseri*, 1500.
 पनसेल *pansel*, 923.
 पनसहा *panhanda*, 419, 465.
 पनही *panahi*, 735.
 पना *pana*, 711.
 पनार *panār*, 365.
 पनाह *panāh*, 711.
 पनिसागर *paniāgar*, 1252.
 पनिसाण्ड *paniyāḍēl*, 915.
 पनियोषा *paniyocha*, Appendix, 16.
 पनियोळें *paniyāuleñ*, 1217.
 पनिसाह *paniwāh*, 915.
 पनिसहा *panihanda*, 419.
 पनिसहा *panihata*, 963.
 पनिसा *paniha*, 922.
 पनिसारा *panihāra*, 419, 915.
 पनिसौवा *panihauwa*, 1064.
 पनुचौ *panuāñ*, 1272.
 पनौठी *panauti*, 660.
 पनौषा *panaula*, 801.
 पन्व *panth*, 1073.
 पन्ना *panna*, 1462.
 पन्नि *pannik*, 363.
 पन्नि *pannikh*, 363.
 पन्नी *panni*, 363, 567.
 पपरा *papra*, 1133, 1272.
 पपरी *papri*, 860.
 पपन *paban*, 1437.
 पपन परिचा *paban parichehha*, 1437.
 पपनकी *pamri*, 1037.
 पपनी *pambhi*, 898.
 पर *par*, 393, 1088, 1394, 1451,
 1478, 1485.
 परकडो *parkattho*, 91, 404, 1141.
 परकड *parkath*, 286, 408.
 परकार *parkār*, 1056.

परन्कास *parkal*, 404, 419, 512,
 519.
 परकिया *parakiya*, 1272.
 परन्कहा *parkhanda*, 740.
 परन्कह *parkhab*, 1484.
 परकिहा *parakhiya*, 1484.
 परन्की *parkhi*, 1484.
 परन्कहनी *pargahni*, 532.
 पॅरन्गा *panrga*, 832, 83.
 परन्कहनी *pargharni*, 532.
 परन्कहूँ *parchhūn*, 924.
 परन्कहो *parchhatti*, 1245.
 परन्कहो *parchhatti*, 1245.
 परन्कह *parchhan*, 1316.
 परन्का *parchha*, 319i, 365, 713,
 952.
 परन्कावन *parchhawan*, 1316.
 परन्कावनी *parchhauni*, 1316.
 परन्का *parja*, 1215.
 परन्कापत *parjapat*, 572.
 परन्तर *partar*, 1028.
 परन्तहा *partaha*, 485.
 परन्ता *parta*, 353, 501, 797, 799,
 1028.
 परन्ताहर *partāhar*, 292.
 परन्ताहा *partāha*, 485.
 परन्ती *parti*, 501, 797, 799, 912,
 1147, 1229.
 परन्थन *parthan*, 630, 1272.
 परन्थनी *parthani*, 630.
 परन्दा *parda*, 216, 223, 246, 467.
 परन्धान *pardhān*, 1450.
 परन्निहार *parnikār*, 292.
 परन्नीहा *parnauha*, 365.
 परन्पेठ *parpeth*, 1487.
 परन्पैठ *parpainth*, 1487.
 परन्बत *parbat*, 1087.
 परन्बल *parbal*, 736.
 परन्मल *parmal*, 1272.
 परन्माज *parmān*, 1487.

परन्वर *parwar*, 1073.
 परन्वल *parwal*, 736.
 परन्वसन्ती *parwasti*, 1209e.
 परन्वाह *parvāh*, 1428.
 परन्साह *parsād*, 975.
 परन्सोती *parsoti*, 787.
 परन्सौती *parsauti*, 1398, 1409, 1412.
 परन्सौती के कामार *parsauti ke kamāi*,
 1412.
 परन्हा *parhata*, 91.
 परन्हाडा *parhattha*, 408.
 परन्वे *parve*, 48.
 परार *parāi*, 713.
 पराप्रब *parāeb*, 1425.
 पराँठ *parānth*, 833.
 पराठा *parātha*, 1272.
 परात *parāt*, 460, 681, 797.
 पराँत *parānt*, 797.
 पराता *parāta*, 797.
 परास *parās*, 124, 234.
 परिचठ *pariath*, 91.
 परिकठ *parikath*, 91.
 परिच *parikh*, 1484.
 परिच्छा *parichchha*, 1437.
 परिचन *parichhan*, 1316.
 परिचावन *parichhāwan*, 1316.
 परिचा *pariya*, 713, 832.
 परिचाप्रब *pariyāeb*, 1115.
 परिचाठा *pariyātha*, 408, 404, 934.
 परिचानी *pariyāni*, 640.
 परिचेठा *pariyetha*, 286.
 परिचत *parihat*, 7.
 परिचत *parihath*, 7.
 परिहर *parihar*, 872, 915.
 परिहार *parihār*, 1456.
 परोठ *parit*, 797.
 परुवा *parua*, 436, 1098.
 परुई *parui*, 436.
 परेकिहा *parekhiya*, 1484.
 परेह *pareh*, 1272.

- परेखन *parekhab*, 1484.
 परेठा *paretha*, 408.
 परेता *pareta*, 353, 501.
 परेह *pareh*, 1001.
 परेड *paraitha*, 91.
 परोसिबा *parosiya*, 1113.
 परोधो *parodho*, 1205.
 परोर *parar*, 1073.
 परोरा *parora*, 1073.
 परोल *parol*, 1073.
 परोहन *parohan*, 393.
 परोहित *parohit*, 1347, 1402, 1422,
 1426.
 परौंवा *paraundha*, 1205.
 पल्ले *palai*, 21.
 पल्लंगरी *palangri*, 636.
 पल्लंगिबा *palangiya*, 636.
 पलङ्ग *palang*, 636.
 पलङ्गा *palanga*, 832.
 पल्लटा *patta*, 846.
 पल्लन्टी *palti*, 291, 846, 915, 872.
 पल्लङ्गा *palra*, 641.
 पल्लन्धी *palthi*, 1429.
 पल्लन्धी बेसन *palthi baisab*, 1492.
 पल्लन्धरबा *palmarua*, 1080.
 पल्लन्धरा *palra*, 641.
 पल्लन्धल *pahwal*, 1073.
 पल्लन्धर *pahwār*, 232.
 पल्लन्धर *palhar*, 1010.
 पल्लान् *palāññ*, 402.
 पल्लान्की *palāñki*, 1073.
 पल्लान *palāñ*, 125, 126, 1131.
 पल्लानी *palāñi*, 72, 1153, 1234,
 1245.
 पल्लिबा *paliya*, 719.
 पल्लिहर *palihar*, 798, 802, 858.
 पलेथन *palethan*, 630, 1272.
 पल्ला *palla*, 21, 35, 416, 739, 938,
 1080, 1092, 1245, 1249.
 पल्लो *pallo*, 1310, 1331.
 पल्लहारी *palhāri*, 880.
 पल्लनी *pawani*, 1193.
 पल्लनी पल्लहारी *pawani pasāri*, 1193.
 पल्लही *pawahi*, 914.
 पल्लहारी *pawāññri*, 29.
 पल्ल *pas*, 1120.
 पल्लंगा *pasanga*, 643.
 पल्लंगी *pasangi*, 1398.
 पल्लंघा *pasangha*, 643.
 पल्लंघी *pasanghi*, 1398, 1400.
 पल्लन्नी *pasni*, 61, 1400.
 पल्लन्धरा *pasra*, 646.
 पल्लन्धरी *pansrauññr*, 1252.
 पल्लन्धिबा *pansahiya*, 1005.
 पल्लन्धी *pasahi*, 882.
 पल्लार *pasār*, 363.
 पल्लहारी *pasāri*, 1193.
 पल्लान्न *pasāwan*, 1165.
 पल्लान्ना *pasāwa*, 1015.
 पल्लिन *pasin*, 978.
 पल्लज *pasūj*, 748.
 पल्लेरी *paseri*, 1204, 1500.
 पल्लेवा *pasewa*, 923, 1032.
 पल्लोर *pasoi*, 923.
 पल्लौंङ्ग *pasaunrar*, 1252.
 पल्लौंता *pasaunta*, 1183.
 पल्ल *pah*, 795, 797, 799, 818, 904.
 पल्लन्ना *pahta*, 832, 846.
 पल्लन्धाना *pahchāna*, 478.
 पल्ल परन्धी *pah parti*, 799.
 पल्लरन्धर *paharwār*, 842.
 पल्लन्धरावा *pahrāwa*, 723.
 पल्लरबा *paharua*, 610.
 पल्लरक *pahruk*, 1184.
 पल्लन्टा *pahta*, 424, 571.
 पल्लन्हा *pahla*, 951.
 पल्लन्हा गार *pahla gār*, 952.
 पल्लन्हुल *pahsul*, 74.
 पल्लहस वर *pahās bar*, 1456.
 पल्लिबा *pahiya*, 151, 1006.

- पहिया वाला हर *pahiya wāla har*,
 1006.
 पहिरे *pahire*, 1090.
 पहिरोप *pahirop*, 1435.
 पहिरोपा *pahiropa*, 1435.
 पहिल *pahil*, 818, 1007.
 पहिल चास *pahil chās*, 818.
 पहिल पटावन *pahil patāwan*, 1007.
 पहिलार *pahila*, 1057, 1092.
 पहिला मॉंटी के बीया *pahila mānti ke
 biya*, 1057.
 पहिलोट *pahiloṭh*, 1114.
 पहिलोट or पहिलौंठ गास *pahiloṭh or
 pahilaunṭh gās*, 1114.
 पहिलौंठ *pahilaunṭh*, 1114.
 पहिलौठा *pahilaunṭha*, 1397.
 पही *pahi*, 797.
 पडंच *pahunch*, 1011, 1487.
 पडंच परमान *pahunch parmān*, 1487.
 पडंचारी *pahunchāri*, 757.
 पडंची *pahunchi*, 757, 768.
 पडंचे *pahunche*, 1487.
 पडंचे दाम *pahunche dām*, 1487.
 पार *pāi*, 362, 1497, 1499.
 पार करव *pāi karab*, 362.
 पारं *pāi*, 1218.
 पाएट *pāēt*, 915, 1098.
 पाएट घुमाएव *pāēt ghumāēb*, 1098.
 पाएठ *pāeth*, 846, 872.
 पाएन *pāēn*, 553.
 पाएर *pāēr*, 858.
 पाक *pāk*, 289.
 पांक *pānk*, 788, 789.
 पाकल *pākal*, 1263.
 पांकी *pānki*, 789, 898.
 पाके *pāke*, 965.
 पाक *pākḥ*, 1251.
 पाका *pākha*, 1251.
 पाग *pāg*, 724, 1272.
 पांगल *pāngal*, 875.
 पागुर *pāgur*, 1143.
 पागुर करव *pāgur karab*, 1143.
 पांच *pānch*, 1138.
 पाचक *pāchak*, 1272.
 पांच कलियान *pānch kaliyān*, 1138.
 पांचक *pānchakkḥ*, 76.
 पाचकू *pāchakū*, 11, 269.
 पाचर *pāchar*, 251, 269, 1251.
 पाँचा *pāncha*, 76.
 पाँचा दूचा *pāncha dūa*, 909.
 पांचे *pānche*, 1445.
 पाँचो *pāncho*, 723, 1456.
 पाँचो दूक कपडा *pāncho tūk kapra*,
 723.
 पाँचो पीर *pāncho pīr*, 1456.
 पाचव *pāchhab*, 1030.
 पाचा *pāchha*, 1087.
 पाचिल *pāchhil*, 1089.
 पाङू *pāchhu*, 1234.
 पाज *pāj*, 1143.
 पाज करव *pāj karab*, 1143.
 पाँजा *pānja*, 882, 884, 1013, 1194,
 1196.
 पाँजी *pānji*, 1354.
 पाँजौ *pānjau*, 884.
 पाजा *pājha*, 1153.
 पाठ *pāt*, 11, 389, 889, 940, 924,
 1098.
 पाठ *pāta*, 29.
 पाठ जोतव *pāt jotab*, 1098.
 पाठ लगएव *pāt lagāēb*, 1098.
 पाटन *pātan*, 233.
 पाटना *pātna*, 233.
 पाटवाला *pātwāla*, 889.
 पाटा *pāta*, 11, 317, 319m, 424.
 पाटी *pāti*, 243, 248, 626, 638, 738,
 843.
 पाटो *pāto*, 11.
 पाठ *pāth*, 429, 889.
 पाठा *pātha*, 1122.

बाढी *pāthi*, 1122.
 बाढ़ *pār*, 1257.
 पाँवर *pānvar*, 853.
 पाढ़ा *pāra*, 1120.
 पाड़ी *pāri*, 1120.
 पाड़ *pārḥ*, 429, 588, 1050.
 पाड़ि *pārhi*, 745.
 पात *pāt*, 764, 767, 868.
 पातन *pātan*, 880.
 पातर *pātar*, 858.
 पाता *pāta*, 21, 237.
 पांता *pānta*, 814.
 पाती *pāti*, 655, 1090.
 पांती *pānti*, 814, 857, 1050.
 पाथक *pāthak*, 1339.
 पाथन *pāthab*, 853.
 पाथर *pāthar*, 162, 858, 1080.
 पाथल *pāthal*, 853.
 पाथा *pātha*, 137, 146.
 पान *pān*, 767, 822, 1049, 1217, 1432.
 पाण पाण *pān āḥās*, 822.
 पाणदार *pāndār*, 475.
 पाण पूल *pān phāl*, 1432.
 पाणि *pāni*, 240, 1234, 1314.
 पाणि तूरल *pāni tūral*, 240.
 पाणि तोड़न *pāni torab*, 240.
 पाणी *pāni*, 919, 922, 1007, 1090,
 1092, 1145, 1159, 1419.
 पाणी देव *pāni deb*, 1419.
 पापर *pāpar*, 1272.
 पांभी *pāmbhi*, 898.
 पाया *pāya*, 638, 1256.
 पार *pār*, 1113, 1205.
 पारकत *pārkhāt*, 777.
 पारचा *pārcha*, 1370.
 पारस नाथ *pāras nāth*, 1456.
 पारन *pārāb*, 865, 873.
 पारा *pāra*, 254, 1205.
 पारा पारी *pāra pāri*, 291.
 पारी *pāri*, 291, 436, 832, 872.

पारीवाला *pāriwāla*, 1184.
 पावेनी *pārbati*, 1443.
 पाल *pāl*, 238, 319m, 920c, 1115,
 1194, 1196, 1204.
 पाल पसेरी *pāl paseri*, 1204.
 पालल *pāla*, 14.
 पालकी *pālki*, 241, 1073.
 पालक *pālak*, 1073, 1209e, 1394.
 पाल काण *pāl khāḥb*, 1115.
 पालल *pālat*, 830.
 पाला *pāla*, 1080, 1249.
 पालो *pālo*, 14, 194, 938, 1308, 1331.
 पाळो मोठवा *pālo motha*, 938.
 पाव *pāv*, 1500.
 पाँव *pāñw*, 771, 1341.
 पाँवजेव *pāñujeb*, 771.
 पावत *pāvat*, 771, 939.
 पावना *pāvna*, 1488.
 पाँव पखारी *pāñw pakhāri*, 1341.
 पाँव सङ्कर *pāñw sankar*, 771.
 पावा *pāva*, 638, 1054, 1500.
 पावे *pāve*, 1088, 1486.
 पाव *pās*, 29, 1050.
 पासंग *pāsangh*, 643, 1484.
 पासंग देखल *pāsangh dekhāl*, 1484.
 पासङ्ग *pāsang*, 60.
 पासा *pāsa*, 29, 866.
 पासी *pāsi*, 74, 115, 374, 638.
 पासो *pāso*, 29.
 पासी *pāhi*, 198, 1215, 1218.
 पासी कास *pāhi kāst*, 1218.
 पाहुर *pāhur*, 1125.
 पाहे *pāhe*, 1050.
 पिचरा *piara*, 1136.
 पिचरी *piari*, 1327, 1348.
 पिचनी *piuni*, 337.
 पिकदाव *pikdān*, 707, 711.
 पिकदावी *pikdāni*, 707.
 पिककड़ा *pichhkara*, 172.
 पिककड़ा *pichhlakra*, 172.

- पिबाड़ी *pichhāri*, 113.
 पिबुषा *pichhua*, 224, 726, 1483.
 पिबुषानी *pichhuāni*, 1237.
 पिबुषार *pichhuār*, 1237,
 पिबुषारा *pichhuāra*, 1237.
 पिबुनी *pichhutti*, 1237.
 पिबुत *pichhūt*, 1237.
 पिबौरा *pichhaura*, 740, 741.
 पिबन्वा *pijwa*, 1264.
 पिबावळ *pijwāl*, 25.
 पिबावा *pijāwa*, 1264.
 पिडन्ना *pitna*, 480.
 पिडन्नी *pitni*, 887.
 पिडावळ *pitāwāl*, 25.
 पिडोर *pitōi*, 1074.
 पिटौषा *pitāua*, 372, 713.
 पिटौर *pitaur*, 103.
 पिडा *pittha*, 1272.
 पिडी *pitthi*, 1272.
 पिठार *pitthār*, 1203, 1272, 1439.
 पिठिया *pithiya*, 126.
 पिंर *pinrar*, 575.
 पिंर *pirhāt*, 341.
 पिंरसरि *pinrhsari*, 337.
 पिंरिया *pirhiya*, 176, 179, 182, 200,
 332, 457, 467, 487, 587, 623,
 634.
 पिंरुरी *pinrhuri*, 575.
 पिंरुर *pirhaur*, 575.
 पिण्ड *pind*, 919.
 पिण्डा *pinda*, 466, 1243, 1425,
 1426, 1427.
 पिण्डा पराण्ड *pinda parāḅ*, 1425.
 पिण्डी *pindi*, 775.
 पितरन्हेली *pitarseli*, 1073.
 पिनिक्क *pinik*, 1035.
 पिनाुरी *pinauri*, 575.
 पिना *pinna*, 1031.
 पिपरा *pipra*, 1075, 1185.
 पिपरा *piyara*, 1264.
 पिषा *piya*, 1087.
 पिषाज *piyāj*, 1073.
 पिषादा *piyāda*, 871.
 पिषादा *piyāla*, 465, 711, 713.
 पिषाली *piyāli*, 711.
 पिरकी *pirki*, 1179.
 पिरगदान *piragdān*, 707.
 पिरगिठी *pirgithi*, 527.
 पिरही *pirhi*, 487.
 पिरिकदान *pirikdān*, 707.
 पिरित *pirit*, 914, 971, 1203.
 पिलण्डा *pilanda*, 466.
 पिलणी *pilhi*, 1171.
 पिलुषा *pilua*, 1074.
 पिल्लु *pillu*, 1074.
 पिसन्ना *pisna*, 625.
 पिसन्वन *piswan*, 625.
 पिषार *pisāi*, 625.
 पिसान *pisān*, 625, 1085, 1272.
 पिहकर *pihkar*, 705.
 पिषिका *pihika*, 1074.
 पी *pi*, 1274.
 पीचनी *piāni*, 1023.
 पीचर *piar*, 1136.
 पीर *pie*, 1026.
 पीच *pich*, 1272.
 पीचर *pichar*, 965g.
 पीटन *pitān*, 575.
 पीटव *pitāb*, 391, 887.
 पीठा *pittha*, 1272, 1378.
 पीठी *pithi*, 1272.
 पींर *pinr*, 575, 268, 917, 953.
 पींरु *pinra*, 1251.
 पींरु *pinri*, 775.
 पीरु *pirha*, 332, 457, 467, 623,
 634.
 पीरि *pirhi*, 634.
 पीरि *pirhi*, 623, 634.
 पीतर *pitār*, 664.

- पीना *pina*, 263, 1031.
 पीना खली *pina khalli*, 263.
 पीनी *pīni*, 337, 1023.
 पीबे *pibe*, 1166.
 पीबर *piyar*, 1003, 1264.
 पीबा *piya*, 1274.
 पीर *pīr*, 337, 1376, 1456.
 पीर का नैजा *pīr ka nuja*, 1376.
 पीरिच *pīrich*, 325.
 पीरिस *pīris*, 325.
 पीरी *pīri*, 1098, 1348.
 पीरी में जोतब *pīri meñ jotab*, 1098.
 पीरो *pīro*, 1074.
 पीला *pīla*, 1264.
 पुबरन्वी *puarsi*, 898.
 पुबरा *puara*, 894.
 पुबाड़ी *puāri*, 1009.
 पुबार *puār*, 894.
 पुबारी *puāri*, 1009.
 पुबारी के जोत *puāri ke jot*, 1009.
 पुस *puis*, 817, 827.
 पुस धरब *puis dharab*, 817.
 पुख *pukh*, 1082, 1086.
 पुख *puchchh*, 726.
 पुखी *puchchhi*, 1285, 1343.
 पुखड़ा *puchhra*, 614.
 पुखारी *puchhāri*, 1428.
 पुखारो *puchhāro*, 1428.
 पुखिया *puchhīya*, 614.
 पुखेठ *puchhet*, 335c.
 पुखेडा *puchheta*, 335e.
 पुखौडा *puchhauta*, 335e.
 पुखमाल *pujmāl*, 388.
 पुजार *pujāi*, 1198.
 पुंजौर *punjaur*, 890.
 पुंजी *punji*, 1485.
 पुंठी *putthi*, 152.
 पुतर् *putr*, 1394.
 पुतर्ना *putra*, 957.
 पुतर्णा *putla*, 67.
 पुतर्णी *putli*, 740.
 पुता *puta*, 990.
 पुतिबा *putiya*, 1248.
 पुता *putta*, 1248.
 पुती *putti*, 344, 957, 990, 1248.
 पुदेना *pudena*, 1073.
 पुनरन्वस *punarbas*, 967, 1082, 1086.
 पुनर *punhar*, 547.
 पुहु *punu*, 719, 741 (footnote), 1272.
 पुपरा *pupra*, 1075, 1183.
 पुर्जा *purja*, 1464, 1480.
 पुर्जी *purji*, 1464.
 पुर्नानो *purnoo*, 1183.
 पुर्ना *purba*, 1082.
 पुर्ना बाद *purba khārkh*, 1082.
 पुर्ना फगुनी *purba phaguni*, 1082.
 पुर्नव *purwat*, 895.
 पुर्ना *purwa*, 1087, 1088.
 पुर्ने *purwe*, 819.
 पुर्नेवा *purwaiya*, 1087, 1088.
 पुर्हिवा *purahiya*, 1114, 1117.
 पुर्वा *puriya*, 1480.
 पुर्ख *purukh*, 1274.
 पुर्खक *purukhak*, 604.
 पुरेषी *puresi*, 898.
 पुरेभ *purain*, 1401.
 पुरोहित *purohit*, 1347.
 पुरौता *purainta*, 1204.
 पुला *pulla*, 894.
 पुली *pulli*, 585, 929.
 पुश्तैल *pushtail*, 335e.
 पुश्तङ्ग *pushtang*, 226.
 पुश्ते *pustai*, 1119.
 पुश्तङ्ग *pustang*, 226.
 पुष्ठी *pusti*, 1248.
 पू *pū*, 1272.
 पूबा *pūa*, 1272.
 पूंज *pūnj*, 890.
 पूजा *pūja*, 1319, 1420, 1434, 1438, 1442.

- पूंजी *pūñji*, 1485.
 पूंजी पहा *pūñji patta*, 226.
 पूत *pūt*, 1043.
 पूतक *pūtāk*, 781.
 पूता *pūta*, 1248.
 पूती *pūti*, 344.
 पूर *pūr*, 1088, 1118, 1201.
 पूरन *pūran*, 1347.
 पूरब *pūrab*, 1082.
 पूरब भद्रपद *pūrab bhadrpad*, 1082.
 पूरा *pūra*, 136, 1118, 1381, 1384.
 पूरि *pūri*, 1002n.
 पूरिस *pūris*, 923, 1493.
 पूरी *pūri*, 884, 1204, 1272, 1405.
 पूसा *pūsa*, 882, 894.
 पूस *pūs*, 1082, 1092.
 पेचासा *pedla*, 713.
 पेकन्धा *pekcha*, 1061.
 पेकन्धी *pekchi*, 1061.
 पेंगनी *pengni*, 168, 203.
 पेचकस *pechkas*, 325, 417.
 पेचन्दार *penchdār*, 473.
 पेचवान *pechwān*, 473, 475.
 पेठन्धली *peṭhālī*, 1171.
 पेठपचरा *peṭpachra*, 251.
 पेठपोङ्गुसा *peṭponchhua*, 1397.
 पेठारहा *peṭārha*, 585, 657.
 पेठारही *peṭārhi*, 657, 963, 1074.
 पेठार *peṭār*, 125, 657.
 पेठारन्धी *peṭārhi*, 1074.
 पेठारा *peṭāra*, 585c, 657.
 पेठारी *peṭāri*, 45, 657, 887, 963.
 पेठारी *peṭāhi*, 963.
 पेठौक *peṭauk*, 1171.
 पेंरुनी *penrni*, 63, 306.
 पेंतावन *peṭāwan*, 1439.
 पेंनेनी *peneni*, 551.
 पेन्हापस *penhāel*, 1164.
 पेपन्धी *pepchi*, 1061.
 पेसाज *peyāj*, 1073.
 पेरन्दार *permdār*, 858.
 पेरन्ना *perwa*, 48.
 पेवन्नी *pevni*, 337.
 पेशगी *peshgi*, 1210.
 पेवन्ना *pehna*, 79.
 पेवान *pehān*, 79, 81.
 पेवानी *pehāni*, 45.
 पेंच *pench*, 325, 473, 726.
 पेचक *pechak*, 498.
 पेठ *peṭ*, 251, 1465.
 पेठन्धली *peṭphullī*, 1176.
 पेठा *peṭa*, 1465.
 पेठावाला *peṭāwāla*, 1219.
 पेठी *peṭi*, 261, 279.
 पेठे *peṭe*, 1043.
 पेठ *peṭh*, 1487.
 पेठा *peṭha*, 1272.
 पेठी *peṭhi*, 872.
 पेदब *perab*, 264.
 पेड़ा *pera*, 814, 1272.
 पेंद *pend*, 80.
 पेंदा *penda*, 80.
 पेंदी *pendi*, 80.
 पेंदो *pendo*, 80.
 पेना *pena*, 98.
 पेनी *peni*, 80.
 पेरब *perab*, 264.
 पेखन *pehan*, 486.
 पेवन *pewan*, 738.
 पेवन्द *pewand*, 738.
 पेंकरा *painkra*, 114.
 पेंजनी *painjni*, 771.
 पेंजनी *painjani*, 168, 169, 170, 203.
 पेंठानी *peṭhāni*, 1043.
 पेंताना *peṭāna*, 638.
 पेंसारी *peṭsāri*, 1350.
 पेंचगा *peṭhta*, 424.
 पेंकड़ *peṭkar*, 198.
 पैकर *paikar*, 105, 114, 198, 1130.
 पैकर *paikar*, 105, 114.

- पेसक *paikal*, 198.
 पेंच *painch*, 846, 1476.
 पेंचा *paincha*, 1476.
 पेंचेदार *painchedār*, 727.
 पैजामा *pajāma*, 727, 746.
 पैठा *paitha*, 424.
 पेंठ *painth* 1487.
 पेंठी *painthi*, 915.
 पैर *pairh*, 105.
 पैदा *pairhā*, 105.
 पैत्रिक *pairtrik*, 1299.
 पैदा *paيدا*, 1028.
 पैम *pain*, 836, 916, 954, 1489.
 पैना *paina*, 23, 98.
 पैनि *paini*, 836, 916, 954.
 पैया *paiya*, 967, 1074, 1076, 1086, 1088.
 पैर *pair*, 891, 892, 959, 1341.
 पैर पखरवा *pair pakharua*, 1341.
 पैर पखारी *pair pakhāri*, 1341.
 पैरा *paira*, 858, 959, 1096.
 पैरी *pairi*, 771.
 पैला *paila*, 24, 343, 398, 714, 914.
 पैस *pais*, 817, 827.
 पैस धरव *pais dharab*, 817.
 पैसा *paisa*, 1500.
 पैसे *paise*, 1479.
 पैसे रुपैया *paise rupaiya*, 1479.
 पैहार *paihār*, 1218.
 पोदार *poār*, 894, 963, 1183.
 पोदारी *poāri*, 1074.
 पोखन्ता *pokhta*, 1235.
 पोखन्ना *pokhra*, 916, 1379.
 पोखन्ना खोदव *pokhra khodab*, 1379.
 पोखारा *pochāra*, 1267.
 पोखारा वाळा *pochāra wāla*, 1267.
 पोखन्नी *pochhni*, 1030.
 पोंचन्नाळा *ponchhwāla*, 1109.
 पोंचिवा *ponchhiya*, 224.
 पोडुवा *pochhua*, 1272.
 पोधानी *pothāni*, 638.
 पोदीना *podina*, 1073.
 पोदेना *podena*, 1073.
 पोरन्नीवो *pornovo*, 1011.
 पोरन्ना *porāna*, 923.
 पोराना *porāna*, 1010.
 पोरैया *poraiya*, 1114.
 पोखिवा *pokhiya*, 353.
 पोखन्ता *posta*, 263, 1028.
 पोखन्नाळक *pospālak*, 1394.
 पोखन्नुत *posput*, 1394.
 पोखन्नाळक *posbālak*, 1394.
 पोखन्नीडा *posbeta*, 1394.
 पोखिवा *posiya*, 1394.
 पोखिवा खेच *posiya leb*, 1394.
 पोळा *posta*, 1183.
 पोंचन्ना *ponhra*, 1008.
 पोळा *poa*, 1024.
 पोर *poi*, 1009, 1010, 1017.
 पोखव *pokab*, 1171.
 पोखर *pokhar*, 916.
 पोखरी *pokhari*, 916 (footnote).
 पोंगी *pongi*, 472.
 पोचो *pocho*, 984.
 पोखव *pochhab*, 1030.
 पोंची *ponchhi*, 614.
 पोड *pot*, 1073.
 पोडो *poti*, 1073.
 पोडा *pora*, 1398.
 पोंडा *ponra*, 1005.
 पोडा *porha*, 1006.
 पोंडा *ponrha*, 1005.
 पोत *pot*, 536, 1220.
 पोता *pota*, 1220.
 पोतेदार *potedār*, 1215.
 पोर *por*, 769, 1010, 1012.
 पोर खोरन्ना *por chhorna*, 1010.
 पोरा *pora*, 894, 1183.
 पोळा *pola*, 353.
 पोळी *poli*, 353.

पोष *pos*, 1235.
 पोसत *posat*, 1028.
 पौदखी *paudandi*, 213.
 पौताना *pautāna*, 638.
 पौतिया *pautiya*, 45.
 पौथाना *pauthāna*, 638,
 पौथी *paunalli*, 372.
 पौनिया *pauniya*, 456, 686, 1193.
 पौषा *paua*, 244, 248, 638, 1054,
 1500.
 पौंछी *paunchhi*, 1074,
 पौंठी *pauti*, 954.
 पौठ *pauth*, 954.
 पौठा *pautha*, 934, 939, 950.
 पौड़ा *paura*, 1247.
 पौंड़ा *paunra*, 308.
 पौंड़ी *paunri*, 646, 1005.
 पौंदा *paunrha*, 309.
 पौंही *paunrhi*, 309.

पौता *pauta*, 656.
 पौतान *pautān*, 363.
 पौती *pauti*, 45, 656.
 पौंठी *paunti*, 656.
 पौदर *paudar*, 280, 614, 941.
 पौदर के माँष *paudar ke mānth*, 941,
 पौधा *paudha*, 949.
 पौना *pauna*, 319, 307, 456, 738,
 686.
 पौनार *paunār*, 365.
 पौनी *pauni*, 1193.
 पौर *paur*, 280, 436, 888, 891,
 959.
 पौरी *pauri*, 262, 280, 436, 891,
 1009.
 पौसर *pausār*, 363 (12).
 पौंसर *paunsār*, 363 (12).
 पौष *pauh*, 797.
 प्रीत *prīt*, 1209a.

॥ फ ph ॥

फधोरा *phaora*, 27.
 फकाह *phakāh*, 858.
 फकिराना *phakirāna*, 1203.
 फकीर *phakīr*, 669, 1203, 1234.
 फगुवाही *phaguvāhi*, 1198.
 फगुनी *phaguni*, 1039, 1082.
 फटकन *phatkan*, 1246, 1262.
 फटका *phatka*, 477.
 फटकी *phatki*, 477, 828.
 फट्ठा *phatha*, 1074, 1105.
 फड़ा *phattha*, 654, 1074.
 फठी *phatthi*, 492, 654.
 फठाह *phathāh*, 1105.
 फठी *phathi*, 224.
 फड़ *phar*, 178, 204, 214.
 फड़का *pharka*, 185.
 फड़की *pharki*, 1416.
 फड़ही *pharhi*, 63.
 फड़वा *pharua*, 63.

फथा *phanda*, 726.
 फतह *phatah*, 473.
 फतह पेंच *phatah pench*, 473.
 फतिङ्गी *phatingi*, 1074.
 फतील सोज *phatil soj*, 711.
 फतेहा *phateha*, 463,
 फँदनी *phandni*, 115.
 फँदिया *phandiya*, 375, 828.
 फनकी *phanki*, 376, 115.
 फनगी *phangi*, 1074.
 फनिगा *phaniga*, 1074.
 फणी *phanni*, 376.
 फर *phar*, 178, 179, 184, 204, 585,
 1024, 1058.
 फरकगुहाड़ा *pharakjhāra*, 1105.
 फरकतिसावन *pharkatiyāvan*, 1198.
 फरका *pharka*, 646, 1183, 1245.
 फरकाना *pharkāna*, 1198.
 फरकिला *pharkilla*, 179, 164.

- फरकिल्लो *pharkill*, 164.
 फरकी *pharki*, 29.
 फरकहत्ती *pharkhatti*, 1485.
 फरगवाव *phārgāwal*, 25.
 फरद *pharad*, 502.
 फरमी *pharni*, 818.
 फरमा *pharma*, 321, 326, 424, 484.
 फरमादस *pharmais*, 1201.
 फरली *pharli*, 1116.
 फरस *pharas*, 750.
 फरसा *pharsa*, 27, 319k.
 फरसी *pharsi*, 473.
 फरसा *pharha*, 335b.
 फरनी *pharhi*, 469, 1272.
 फरा *phara*, 1272.
 फराठा *pharātha*, 1272.
 फराठी *pharāthi*, 654.
 फरिकाणा *pharikāna*, 1198.
 फरिङ्गा *pharinga*, 1074.
 फरिवा *phariya*, 37, 740.
 फरी *phari*, 29, 179.
 फरवा *pharuha*, 27, 63, 319.
 फरुही *pharuhi*, 63, 303, 319, 1272.
 फरेवा *phareha*, 335b.
 फरो *pharo*, 29.
 फरौठा *pharauta*, 335b.
 फल *phal*, 29, 1474.
 फलकर *phalkar*, 1232.
 फलनार *phaltār*, 379.
 फलदान *phaldān*, 1287.
 फलसा *phalsa*, 401.
 फलिवा *phaliya*, 740.
 फलुनी *phalguni*, 1039.
 फली *phalli*, 401, 415.
 फंसरनाली *phansargāli*, 115.
 फसिलाना *phasilāna*, 1200.
 फहुरा *phahura*, 27, 319k, 369.
 फहुरी *phahuri*, 63, 303, 321.
 फहोड़ा *phahora*, 27.
 फहोरा *phahora*, 27.
 फाँक *phānk*, 1014.
 फाँकी *phānki*, 1139.
 फागुन *phāgun*, 1039, 1082, 1083, 1084, 1092.
 फाजिल *phājil*, 1186, 1463b.
 फाठ *phāt*, 1070, 1214.
 फाटक *phātak*, 1249.
 फाठी *phāthi*, 1074.
 फाँड़ *phānr*, 726.
 फाड़न *phāran*, 1161.
 फाँड़ा *phānra*, 726, 1074.
 फाँड़ी *phānri*, 919, 1074.
 फाँद *phānd*, 382.
 फाँदा *phānda*, 382, 648.
 फान *phān*, 646.
 फानी *phāni*, 646, 828.
 फाँफर *phānphar*, 858.
 फार *phār*, 10.
 फार करा साग्रव *phār karā lāēb*, 25.
 फारकहत्ती *phārkhatti*, 1485.
 फारन *phāran*, 818.
 फारसी *phārsi*, 585f.
 फारसी गोला *phārsi gola*, 585f.
 फारा *phāra*, 10.
 फारी *phāri*, 29, 1139.
 फालसाही *phālsāhi*, 1043.
 फाला *phāla*, 10.
 फाल्गुन *phālgun*, 1039.
 फाव *phāo*, 900, 1483.
 फाँस *phāns*, 115.
 फाँसो *phānsa*, 18.
 फिक *phik*, 99.
 फिककिरी *phitkiri*, 425.
 फिरकी *phirki*, 350, 425, 590, 753.
 फिरना *phiranta*, 1474.
 फिरिस *phirist*, 1483.
 फाँचव *phinchab*, 391.
 फुकाठी *phukāthi*, 529, 570.
 फुकाठी *phukhāthi*, 570.

फुचो *phuchchi*, 432, 713.
 फुटना *phutna*, 1011.
 फुटपूरी *phutpūri*, 1272.
 फुटहरा *phutahra*, 1272.
 फुटथा *phutha*, 433, 1272.
 फुटिया *phutiya*, 1183.
 फुटेहरि *phutehri*, 1272.
 फुटना *phudna*, 99.
 फुदना *phundna*, 100.
 फुदेना *phudena*, 1073.
 फुङ्गी *phungi*, 1008.
 फुङ्गा *phunna*, 100.
 फुफुति *phuphuti*, 741.
 फुफुनी *phuphuni*, 741.
 फुफुन्दी *phuphundi*, 741.
 फुलको *phulko*, 987.
 फुलकोबी *phulkobi*, 1073.
 फुलगरना *phulgarna*, 507.
 फुलतार *phultār*, 379.
 फुलदो *phuldo*, 379.
 फुलदाही *phuldāhi*, 45.
 फुलपता *phulpata*, 1028.
 फुलपती *phulpatti*, 1029.
 फुलबघा *phulbagha*, 1176.
 फुलबात *phulbāt*, 1176.
 फुलभङ्गा *phulbhanga*, 1074.
 फुलवारी *phulvāri*, 813.
 फुलहर *phulhar*, 1076.
 फुलाप्रब *phulāēb*, 1018.
 फुलिबा *phuliya*, 213.
 फुलुकी *phuluki*, 44.
 फुलेना *phulena*, 1183.
 फुलौरी *phulauri*, 1272.
 फुली *phulli*, 1178.
 फुँक *phūnk*, 414.
 फुँकि *phūki*, 1166.
 फुँट *phūnt*, 1065, 1066.
 फुटब *phūtab*, 1018.
 फुटे *phutai*, 1090.
 फुरी *phūri*, 713.

फुल *phul*, 590, 666, 688, 975, 977,
 978, 1018, 1029, 1043, 1434.
 फुल दाक *phul dāk*, 1456.
 फुले *phule*, 1091.
 फुस *phūs*, 1235.
 फुस के घर *phūs ke ghar*, 1235.
 फुहा *phūha*, 1042.
 फेंकलकैक *phenkalkaik*, 1004.
 फेंकार *phenkāi*, 1401.
 फेंकैल *phenkail*, 646.
 फेंककिना *phetkina*, 425.
 फेंकनाल *phetwāl*, 1016, 1019.
 फेंगदन *phetdān*, 1118.
 फेंगवाप्रब *phenhāēl*, 1164.
 फेनुसा *phenusa*, 1164.
 फेफना *phephna*, 1183.
 फेफरियाह *phephriyah*, 1098.
 फेरवैक *pherbaik*, 1156.
 फेरवार *pherwār*, 1097.
 फेरहा *pherha*, 942, 1156.
 फेरुवा *pherua*, 140, 756, 769.
 फेरौंठी *pheraunti*, 1246.
 फेका *pheka*, 646.
 फेडा *pheta*, 259.
 फेंटा *phenta*, 259, 271, 724.
 फेंटी *phenti*, 848.
 फेनी *pheni*, 975, 1272.
 फेनुस *phenus*, 1164.
 फेफरि *phephri*, 841.
 फेर *pher*, 1087.
 फेरब *pherab*, 1246.
 फेरल *pherāl*, 1267.
 फेरा *phera*, 831, 889.
 फेरा फारी *phera phāri*, 291.
 फेड़ *phair*, 178.
 फोकना *phokna*, 1272.
 फोकाठी *phokāthi*, 567.
 फोटा *phota*, 1018.
 फोड़ी *phori*, 748.
 फोंफी *phonphi*, 567, 585.

फोर *phor*, 801.
फौड़ी *phauri*, 1499.
फोरन *phoran*, 1272.

फोरल *phoral*, 1018.
फौज *phauj*, 1127.
फौरा *phaura*, 27.

॥ ब ॥

बघ *bae*, 368.
बकगल *baknal*, 528, 545.
बकनार *baknār*, 528, 545.
बकन *bukam*, 1043.
बकरगलसाब *bakarkasāb*, 1141.
बकुरा *bakra*, 1121.
बकुरी *bakri*, 1121.
बकुर *bakru*, 1122, 1123.
बकुरा *bakla*, 1073.
बकुरा *bakwa*, 1263.
बंकुरा *bankwa*, 1263.
बकुरा *baksa*, 372.
बकुरिस *bakst*, 1194.
बंकुरा *bankua*, 61.
बकुचा *bakucha*, 390.
बकुला *bakula*, 1031, 1074.
बकुली *bakuli*, 1073, 1074.
बकेन *baken*, 1114, 1158.
बकेन के दूध *baken ke dūdh*, 1158.
बकेना *bakena*, 1114.
बकेया *bakeya*, 1074.
बकोरवा *bakoiya*, 975.
बकौ *bakau*, 1263.
बंकौ *bankau*, 1263.
बकर *bakkar*, 1121.
बकी *bakki*, 1074.
बकतौर *bakhtaur*, 1456.
बकरदार *bakhardār*, 1214.
बकुरा *bakhra*, 125, 1214.
बकुरी *bakhri*, 1234.
बकार *bakhār*, 77.
बकारी *bakhāri*, 77, 79.
बखिया *bakhiya*, 748.
बखीर *bakhīr*, 1272.
बखेया *bakhea*, 748.

बखोर *bakhor*, 1125.
बकुरवा *bagchhalla*, 1138.
बंगठी *bangthi*, 1017.
बगदोर *bagdor*, 113.
बंगुरा *bangra*, 232.
बगमुची *bagmuchi*, 516.
बंगुरा *bangra*, 1049.
बंगुरा *bangrah*, 799.
बगल *bagal*, 238, 637, 1263.
बगलभरवा *bagalbhara*, 549.
बंगुरा *bangla*, 1049, 1073, 1254.
बगुरी तखिया *bagli takiya*, 637.
बगुरी *bagluti*, 547.
बगुरी *bagsansi*, 516.
बगुरा *bagha*, 116, 930.
बगिया *bagiya*, 813, 1272.
बगुरी *banguri*, 411, 768.
बगुरी *baguli*, 704, 734.
बगेया *bageya*, 1272.
बगेया *bagaiya*, 813, 814.
बगुरी *bangauriya*, 1080.
बगुरी *bangaur*, 329, 1017.
बगुरी *bangaura*, 1017.
बगुरी *bangauri*, 1080.
बकार *baghār*, 1272.
बखेया *baghela*, 363.
बखेया *bagheli*, 469.
बङ्गा *bangā*, 833, 1016.
बकुरा *bachka*, 1272.
बकुरा *bachwa*, 767.
बकाओ *bachāo*, 655.
बखित *bachit*, 1475.
बकुरा *bachcha*, 1116, 1123, 1128.
बकुरा *bachhru*, 1118.

बहवा *bachhwa*, 1118.
 बहिया *bachhiya*, 1118.
 बहेड़ा *bachhera*, 1126.
 बहेड़ी *bachheri*, 1126.
 बजका *bajka*, 1272.
 बजन्दा *bajra*, 985, 987.
 बजार *bajar*, 959.
 बजर बोंग *bajar bong*, 654.
 बजरी *bajri*, 1000.
 बजा *baja*, 959.
 बजाएब *bajæeb*, 1401, 1484.
 बजुला *baiulla*, 767.
 बँभौरा *banjhaura*, 1078.
 बँभौरी *banjhauri*, 1078.
 बन्धड़ *banjhar*, 987.
 बन्धा *banjha*, 1398.
 बटकर *batkar*, 1001.
 बटखरा *batkhara*, 643.
 बटनार *batnāi*, 594.
 बटनी *batni*, 498.
 बंटनु *bantnu*, 902.
 बटरी *batri*, 44, 442.
 बटलोही *batlohi*, 667.
 बटवान *batwan*, 646.
 बटसारी *batsāri*, 1339.
 बटार *batāi*, 913, 902, 903, 914,
 1221, 1468a, 1470.
 बटार खरिहानी *batāi kharihāni*, 914.
 बटाम *batām*, 404, 426.
 बटारी *batāri*, 399.
 बटाही *batāhi*, 399.
 बटियारी *batiyāri*, 382, 646.
 बटिवन *batiwan*, 646.
 बटुषा *batua*, 666, 734.
 बटुई *batui*, 734.
 बटुरी *baturi*, 772, 1000, 1003.
 बटुही *batuh*, 667, 704.
 बटैया *bataiya*, 902.
 बटोरन *batoran*, 899.

बहा *batta*, 43, 44, 288, 627, 692,
 1202, 1474, 1480; Appendix, 14.
 बहा कम्पनी *batta kampani*, 1203;
 Appendix, 14.
 बहा माल *batta māl*, 1202; Appen-
 dix, 14.
 बडू *battu*, 666, 734.
 बड़ *bar*, 741, 1056, 1217.
 बड़ अदमी *bar admi*, 1217.
 बड़का *baraka*, 1263, 1491.
 बड़का गज *baraka gaj*, 1491.
 बड़की *barki*, 1021, 1276.
 बड़गुहमा *barguhuma*, 956.
 बड़गोहमा *baroghuma*, 1075.
 बड़ घोघट *bar ghoghat*, 741.
 बड़गा *banrchha*, 808, 1016.
 बड़द *barād*, 1096.
 बड़धड़ा *barhara*, 768.
 बड़धर *barhar*, 768.
 बड़धरा *barhara*, 280, 891.
 बड़धावन *barhāwan*, 893.
 बड़ही *barhi*, 394, 1074, 1194, 1204.
 बड़ही खाना *barhi khāna*, 394.
 बड़घोड़ा *barhora*, 891.
 बड़ार *barār*, 788.
 बड़ि *bari*, 1087.
 बड़ी *bari*, 503.
 बड़ी सूई *bari sūi*, 503.
 बड़ूचा *bañrūchha*, 1016.
 बड़े *bare*, 478.
 बड़ैरा *bareñra*, 414.
 बड़ैरी *bareñri*, 414.
 बड़ैर *barenr*, 1257.
 बड़ैरा *banrera*, 940.
 बड़ैरी *bareñri*, 1257.
 बड़ैया *baraisa*, 1016.
 बड़नी *barhti*, 1474.
 बड़नी *barhni*, 45, 54, 56, 439, 465.
 बड़ब *barhab*, 1173.

- बर्हान *barhānw*, 893.
 बर्ही *barhi*, Appendix 2a.
 बर्होत्रि *barhotri*, 1475.
 बन्दा *banda*, 1109.
 बन्धा *bandha*, 1109.
 बन्दावत *batāwa*, 1026.
 बन्दास *batās*, 975, 1272.
 बन्दास फेनी *batās pheni*, 975, 1272.
 बन्दासा *batāsa*, 585, 975, 1272.
 बन्दासी *batāsi*, 399.
 बतिसी *batisi*, 558.
 बत्ता *batta*, 224, 179, 1249, 1258.
 बत्ती *batti*, 51, 179, 654, 1258, 1423.
 बथनियारु *bathniyārū*, 1153.
 बथान *bathān*, 1132, 1147, 1153.
 बथानी *bathāni*, 1147.
 बथुआ *bathua*, 1075.
 बद् *bad*, 1125.
 बद् काँम *bad kaum*, 1125.
 बद् खोम *bad khom*, 1125.
 बद्मोहरी *bad mohri*, 1125.
 बद्दरी *badri*, 1088.
 बद्दलै *badlai*, 1461.
 बद्दला *badla*, 548.
 बद्दली *bodli*, 846.
 बद्दलैया *badlāiya*, 846.
 बद्दवान *badwān*, 711.
 बद्दवाँसी *badwānsi*, 808.
 बद्दशगुन *badshagun*, 1454.
 बद्दहा *badha*, 735.
 बद्दहार *badhār*, 828.
 बद्दामी *badāmi*, 769, 1043.
 बद्दारी *badāri*, 77.
 बँदिया *bandiya*, 1098.
 बदीया *badīya*, 417.
 बँदौतनी *bandautni*, 1456.
 बँदौत *bandaut*, 1456.
 बँदौर *bandaur*, 1017.
 बद्धी *baddhi*, 765.
 बधन *badhan*, 432.
- बधना *badhna*, 432, 711, 713.
 बधनी *badhni*, 711.
 बधरना *badharna*, 566.
 बधरा *badhra*, 73.
 बधरिया *badhariya*, 73.
 बधरी *badhri*, 73.
 बधवार *badhwār*, 870.
 बधवारी *badhwāri*, 566.
 बधवाहा *badhwāha*, 870.
 बधार *badhār*, 832.
 बधारू *badhārū*, 73.
 बधिया *badhiya*, 417, 1008, 1112.
 बँधिन *bandhiha*, 829.
 बँधेरी *bandheri*, 121.
 बन *ban*, 158, 178, 268, 478, 558, 813, 815, 842, 844, 852, 869, 874, 1091, 1183, 1185, 1205, 1232, 1254, 1408.
 बन उखाव *ban ukhāo*, 1436.
 बन उसर *ban usra*, 1436.
 बनकर *bankar*, 1232.
 बन्गोरठा *bangoitha*, 852.
 बन घरा *ban ghara*, 1254.
 बन चिहोली *ban chhioli*, 1232.
 बन चिहोली *ban chhihuli*, 815.
 बन्जोवारन *banjowān*, 1073.
 बन्तुलुङ्गी *bantulsi*, 1183.
 बन्नी *banni*, 762.
 बन्पियजुआ *banpiyajua*, 1075.
 बन्पियज *banpiyaj*, 1075.
 बन पोखा *ban posta*, 1183.
 बन्ब *banab*, 1343.
 बन्बुठका *banbhutka*, 1073.
 बन्बसना *banrasna*, 1075.
 बन्बरा *banra*, 236.
 बन्बल *banal*, 1086.
 बन्बवार *banwār*, 1310.
 बन सलुवात *ban salwāt*, 1408.
 बन्बारी *bansāri*, 1075.
 बन्बहार *banhār*, 1480.

बनाप्रब *bandēb*, 25.
 बनि *bani*, 1185.
 बनिज *banij*, 1461.
 बनिचा *baniya*, 1461.
 बनिचाँ *baniyañ*, 914.
 बनिचौटा *baniyauta*, 1188, 1461.
 बनिहार *banihār*, 874, 1184.
 बनिहारा *banihāra*, 842.
 बनिहारी *banihāri*, 869.
 बनी *bani*, 844, 869, 874.
 बनुसार *banusār*, 864, 1436.
 बनौर *banaur*, 1017.
 बनौरी *banauri*, 1080.
 बन्ध *band*, 158, 167, 178, 571, 748,
 1452.
 बन्ध करण *band karab*, 1452.
 बन्धन *bandan*, 1324, 1325.
 बन्धनवार *bandanvār*, 1310.
 बन्धनेवार *bandnevār*, 1310.
 बन्धोबख *bandobast*, 903, 1221.
 बन्धन *bandhan*, 1331.
 बन्धा *bandha*, 1073.
 बन्धा कोपी *bandha kōpi*, 1073.
 बन्धिक *bandhik*, 1480, 1481.
 बन्नी *banni*, 1456.
 बन्सा *bansa*, 24.
 बन्धका *banhka*, 362.
 बन्धखरचा *banhkharcha*, 1207.
 बन्धना *banhna*, 119.
 बन्धनेचा *banhwaiya*, 1201.
 बन्धाप्रब *banhāēb*, 1426.
 बपन्ध *bapans*, 1214.
 बपन्धर *baphar*, 1299.
 बपन्धख *baphans*, 1214.
 बपौती *bapauti*, 1214.
 बपौरी *baphauri*, 1272.
 बबरन्ची *babarchi*, 1248.
 बबरन्ची खाना *babarchi khāna*,
 1248.
 बबुरी *babui*, 1295.

बबुटोला *babutola*, 1217.
 बभन *babhan*, 1285, 1343.
 बभन पुच्छी *babhan puchchhi*, 1285,
 1343.
 बभन्नी *bhabhni*, 787, 1074.
 बभन्नी *babhnaui*, 725.
 बभुखा *babhunta*, 767.
 बभ *bam*, 922.
 बभगोला *bamgola*, 585.
 बभेला *bamaila*, 363.
 बभू *bambu*, 1034.
 बबा *baya*, 914.
 बबाइ *bayāi*, 1201.
 बबाना *bayāna*, 1483.
 बर *bar*, 1005, 1274, 1281, 1287.
 बरई *barai*, 45, 1049.
 बर खल *bar ākh*, 1005.
 बरक *barak*, 1333.
 बरकत *barkat*, 1483.
 बरक बेसाप्रब उठाप्रब *barak baisāēb*
uthāēb, 1333.
 बरन्क *barkas*, 243.
 बरन्का *barka*, 1175.
 बरन्कावर *barkābar*, 727.
 बरन्का बेमारी *barka bemāri*, 1175.
 बरन्की *barki*, 740.
 बरन्का *barkha*, 965, 1083, 1087,
 1088, 1091.
 बरन्की *barkhi*, 1185, 1427.
 बरन्खु *barkhu*, 1117.
 बरग *barag*, 1343.
 बरन्गा *barga*, 1258.
 बरन्गुना *barguna*, 672.
 बरन्गरा *barghara*, 1153.
 बरन्हा *barachchha*, 1287.
 बरन्हा *barchhā*, 102.
 बरन्ही *barchhi*, 102.
 बर हेंका *bar chhenka*, 1287.
 बरन्जौर *barjaur*, 1272.
 बरन्त *bart*, 1442.

- बरत *barat*, 491.
 बरन्ता *barā*, 121, 276.
 बरन्ती *barti*, 121.
 बरन्तुहार *bartuhār*, 1286.
 बरन्तुहारी *bartuhāri*, 1286.
 बरन्तूर *bartūi*, 1285.
 बरन्तूही *bartūhi*, 1286.
 बरन्तूही के भात *bartūhi ke bhāt*, 1286.
 बरद् *barad*, 657, 841, 1087, 1096.
 बरदारी *bardari*, 248, 1236.
 बरद्वनिषा *bardvaniya*, 1456.
 बरद्वान *baradvān*, 702.
 बरदा *barda*, 1118.
 बरदाप्रब *bardāēb*, 1115.
 बरदाप्रब *bardāēl*, 1116.
 बरदाना *bardāna*, 1151, 1201.
 बरदिषा *baridiya*, 1151.
 बरदेकी *bardekhi*, 1285.
 बरध *baradh*, 1096, 1097.
 बरधा *bardha*, 1088, 1094.
 बरधिषाप्रब *barधिषाēb*, 1115.
 बरन *baran*, 12, 784.
 बरनी *barni*, 489.
 बरन्धी *barphi*, 1272.
 बरन्म पिषास *barṁ piṣās*, 1458.
 बरन्मा *barṁa*, 398, 415, 470, 471, 540, 583.
 बरन्मँ *barṁān*, 398.
 बरन्मोतर *barṁotar*, 1209a.
 बररिषा *barariya*, 378.
 बररी *barri*, 1043.
 बररे *barre*, 1043.
 बरल *baral*, 123.
 बरल रस्सी *baral rassi*, 123.
 बरन्वाह *barwāh*, 915, 945.
 बरन्वे *barwe*, 1050.
 बरन्साइन *barsāin*, 1114, 1398.
 बरन्से *barse*, 966, 1084, 1085, 1087, 1090, 1092.
 बरन्से *barsai*, 1088.
 बरन्सेनो *barsaino*, 1398.
 बारह *barah*, 116, 276, 930.
 बारहत्ता *barhattha*, 751.
 बारहत्ती *barhatthi*, 740.
 बारहदारी *barahdari*, 248, 1236.
 बारहब *barhan*, 12.
 बारहम *barham*, 1455, 1456.
 बारहम अस्थान *barham asthān*, 1455.
 बारहम देव *barham deo*, 1456.
 बारहमन् *barahman*, 1217.
 बारहा *barha*, 38, 115, 116, 121, 930.
 बारही *barhi*, 33, 118, 121, 1406.
 बारही *barhai*, 1090.
 बारहौघर *barhaughar*, 1234.
 बरा *bara*, 1272, 1491.
 बराइन *barāin*, 12.
 बराप्रब *barāēb*, 949.
 बरा गज *bara gaj*, 1491.
 बराँटी *brānti*, 975.
 बराठी *barāthi*, 1250.
 बरात *barāt*, 1290.
 बरार *barār*, 788.
 बराखिल *barākhil*, 871.
 बरियात *bariyāt*, 1043, 1290, 1330, 1379.
 बरियार *bariyār*, 800, 808, 922.
 बरियार पानी *bariyār pāni*, 922.
 बरिसे *barise*, 1089.
 बरी *bari*, 994, 1272, 1369, 1381.
 बरुा *barua*, 239, 639, 859.
 बरुका *baruka*, 713.
 बरेन *baren*, 12.
 बरेकी *barekhi*, 767, 1285.
 बरेठा *baretha*, 414.
 बरेव *bareo*, 1050.
 बरेठा *baraittha*, 1050.
 बरैन *barain*, 12.
 बरैनी *baraini*, 12.
 बरौकी *baraukhi*, 1005.

बरौंही *baraunchhi*, 536.
 बलकट *balkat*, 875, 1198, 1223.
 बलकसी *balkasi*, 785.
 बलको *balko*, 984.
 बलखा *balkha*, 388.
 बलखोरवा *balkhoiwa*, 984.
 बलखार *balkhar*, 379.
 बलथर *balthar*, 785.
 बलधूस *baldhūs*, 785.
 बलमन्दार *balamdar*, 767.
 बलरक्खा *bal rakkha*, 870, 871.
 बलरखी *balrakhi*, 870.
 बलरी *balri*, 984.
 बलवा *balwa*, 785.
 बलवाह *bahoāh*, 785.
 बलवार *balsār*, 1008.
 बलसुंदरी *balsundri*, 785.
 बलसुन *balsun*, 785.
 बलसुन्दर *balsundar*, 785, 787.
 बलसुम *balsum*, 785.
 बलसुमी *balsumhi*, 785.
 बलार *balāi*, 1165.
 बलान *balān*, 788.
 बलिदान *balidān*, 1457.
 बलिखा *balista*, 687.
 बलिहा *balīha*, 379.
 बलुथ *baluath*, 377, 785.
 बलुवा *bahua*, 785, 802, 1074.
 बलुवा बाँगर *bahua bāngar*, 802.
 बलुवा भौठ *bahua bhith*, 802.
 बलुर *bahui*, 1074.
 बलुखा *bahukha*, 1004.
 बलुरी *bahuri*, 984.
 बलुवाही *balusāhi*, 1272.
 बलेवा *balea*, 757.
 बलेठा *baletha*, 377.
 बल्लम *ballam*, 102.
 बल्ला *balla*, 183, 185, 200, 322, 940,
 1258.
 बल्लो *balli*, 217, 1258.

बँवरिया *bamwariya*, 363.
 बँवारी *bamwāri*, 363.
 बस *bas*, 1025.
 बसगित *basgit*, 796.
 बँसजोती *banajoti*, 33.
 बँसजोर *banjor*, 931.
 बसती *basti*, 784.
 बसदौरी *basdauri*, 1407.
 बसनी *basni*, 693, 713.
 बँसफँटा *bansphenta*, 654.
 बसन्ती *basanti*, 379.
 बँसफहा *bansphattha*, 654.
 बँसबल्लो *bansballi*, 183.
 बसन्तिया *basmatiya*, 976, 979.
 बसन्वडा *baswanta*, 1183.
 बँसवार *banswār*, 814.
 बँसवारी *banswāri*, 814.
 बसवा *basaha*, 1111.
 बसाह *basār*, 814.
 बसाँही *basānrhi*, 1075.
 बसावन कुँवर *basāwan kuḥar*, 1456.
 बसिया *basiya*, 1272.
 बसिखा *basila*, 395.
 बसुही *basurhi*, 1201.
 बसुला *basula*, 394, 395, 470.
 बसुली *basuli*, 421.
 बसुला *basūla*, 395.
 बसे *base*, 393.
 बसेह *baser*, 814.
 बसाँता *basāunta*, 1075, 1183.
 बँसौरा *bansaura*, 183.
 बल *bast*, 1218.
 बलार *bastar*, 723, 965.
 बह *bah*, 954, 1275.
 बहकल *bahkal*, 1132.
 बहका *bahka*, 533.
 बहखा *bahkha*, 32.
 बहंगी *bahangi*, 651, 657.
 बहगुना *bahguna*, 674.
 बहत *bahat*, 1132.

बहट जाणव *bahat jāḥb*, 1132.
 बहना *bahna*, 713, 954.
 बहव *bahab*, 817.
 बहर *bahar*, 1254.
 बहरगहरा *baharghara*, 1153, 1254.
 बहरन्नी *baharni*, 972.
 बहरन्ने *baharbhām*, 784b, 790.
 बहरन्नी *baharsi*, 784b, 1147.
 बहरिया *bahariya*, 1203, 1458.
 बहरैया *bahraiya*, 1203.
 बहरो *bahro*, 1162.
 बहल *bahal*, 148, 207.
 बहली *bahli*, 148, 207.
 बहलीली *bahloli*, 769.
 बहसल *bahsali*, 356.
 बहारन *bahāran*, 848.
 बहारल *bahāral*, 58.
 बहाने *bahāwe*, 1088.
 बहिंगा *bahinga*, 651, 657.
 बहिया *bahiya*, 1184.
 बहियार *bahiyār*, 3, 784, 832, 1147.
 बहिरा *bahera*, 379.
 बहिला *bahila*, 1114, 1398.
 बही *bahi*, 280, 941, 1462, 1463b
 and c, 1485.
 बही खाता *bahi khāta*, 1462.
 बही पर से नाम उतर गेल *bahi par se
 nām utar gel*, 1485.
 बहुसाधिन *bahuśāsin*, 1293.
 बहुता *bahutta*, 767.
 बहुता *bahunta*, 767.
 बहुत *bahut*, 240, 829, 841, 1002.
 बहुरा *bahura*, 1294, 1443.
 बहुरी *bahuri*, 1272.
 बहू *bahu*, 1275.
 बहैलिया *baheliya*, 381.
 बहै *bahe*, 1087, 1088.
 बहैली *baheli*, 148, 207.
 बहै *bahai*, 1087, 1088.
 बहोरन्नी *bahorni*, 972.

बहोर *bahor*, 1456.
 बहोर *bahor*, 1294.
 बा *ba*, 741, 957, 987, 1001, 1089.
 बाहुन *bāḥg*, 855.
 बाहुग *bāḥg*, 855, 964.
 बैंक *bānk*, 233, 325, 416, 583, 754,
 767, 977.
 बैंकटा *bānkta*, 1077.
 बैंक रुखानी *bānk rukhāni*, 400.
 बाकल *bākal*, 233.
 बाकस *bākas*, 656.
 बैंका *bānka*, 1074.
 बाकी *bāki*, 1463b, 1468a, 1472.
 बैंकी *bānki*, 583, 1074.
 बाकी तबली *bāki tabli*, 1463b.
 बाग *bāg*, 813, 978, 1124.
 बांग *bāng*, 1019, 1020.
 बाग डोर *bāg dor*, 113.
 बाग नर *bāgnar*, 978.
 बांग सखनात *bāng saḥāt*, 1408.
 बांगर *bāngar*, 204, 786, 802.
 बांगर करील *bāngar karail*, 786.
 बांगा *bānga*, 329, 1016, 1017, 1018,
 1019.
 बांगा फूटव *bānga phūtab*, 1018.
 बांगो *bāngo*, 1016, 1017, 1018, 1019.
 बांगो फूटव *bāngo phūtab*, 1018.
 बाहा *bāchha*, 1118.
 बाही *bāchhi*, 1118.
 बाज *bāj*, 585.
 बाजन *bājan*, 1026.
 बाजू *bāju*, 767.
 बांज *bānjh*, 1398.
 बांज बहिला *bānjh bahila*, 1398.
 बांजिन *bānjhin*, 1398.
 बांजी *bānjhi*, 1078.
 बाट *bāt*, 643.
 बांट *bānt*, 902, 1214.
 बांटल *bāntal*, 123.
 बांटल रसी *bāntal rassi*, 123.

बाढी *bāḍī*, 677, 692, 1084.
 बाँडी *bāṅḍī*, 902.
 बाढोतसरग्य *bātotsarg*, 1459.
 बाँड़ *bānr*, 789, 987, 1109.
 बाड़ा *bāra*, 1272.
 बाँड़ा *bānra*, 1109.
 बाड़ी *bāri*, 784, 1040.
 बाड़ों *bāriñ*, 1275.
 बाड़ *bārḥ*, 588, 1080.
 बाड़न *bārhan*, 54.
 बाड़नि *bārhani*, 54.
 बाड़व *bārhab*, 58.
 बाड़ि *bārhi*, 1080.
 बात *bāt*, 478, 1088, 1181.
 बात *bāta*, 233, 1174, 1249, 1258.
 बातो *bāti*, 51, 1258, 1423.
 बादर *bādar*, 1088.
 बादिषा *bādiya*, 417.
 बाध *bādh*, 639, 784, 1147.
 बाँध *bāndh*, 77, 833, 919, 953.
 बाँधव *bāndhab*, 1378.
 बाधा *bādha*, 642, 735.
 बाधी *bādhi*, 184.
 बान *bān*, 167, 478, 585, 639, 864,
 982, 1113.
 बानर *bānar*, 834.
 बाना *bāna*, 1042, 1195.
 बानी *bāni*, 849, 1195.
 बान्ह *bānh*, 741, 919, 953.
 बान्हल *bānhal*, 444.
 बाप *bāp*, 393, 1043.
 बापक *bāpak*, 356, 781.
 बाँबू *bāmbu*, 1034.
 बाभन *bābhan*, 964, 1451.
 बाभन *bāman*, 999 (note).
 बाबा *bāya*, 914.
 बारन्ता *bārta*, 375.
 बारह *bārḥ*, 1020.
 बारन्तो *barho*, 1086.
 बारा *bāra*, 562, 1205, 1272.

बारी *bāri*, 753, 807, 832, 1016,
 1148, 1218.
 बारी बस *bāri bast*, 1218.
 बाल *bāl*, 788, 958, 984, 986, 990,
 1189, 1411.
 बाल चढ़ *bāl chhar*, 1381.
 बाल तराशी *bāl tarāshi*, 1411.
 बालन *bālam*, 1070.
 बालन खीरा *bālam khira*, 1070.
 बाला *bāla*, 757, 768, 785, 936,
 1074, 1258.
 बालिस *bālis*, 1266.
 बाली *bāli*, 753, 764, 958.
 बालीस *bālis*, 637.
 बालू *bālu*, 324, 1074.
 बालूचर *bālūchar*, 1037.
 बालू मेज *bālu mej*, 324.
 बालू घासी *bālu sāhi*, 1272.
 बाले *bālai*, 1376.
 बाले मोर्षा *bālai mōyān*, 1376.
 बावग *bāwag*, 818, 855, 857, 863,
 964, 1008, 1039.
 बावग करव *bāwag karab*, 855.
 बावली *bāwli*, 215, 224, 704, 920.
 बास *bās*, 356.
 बाँस *bāns*, 183, 242, 249, 814, 931,
 978, 1491.
 बाँसक *bānsak*, 814.
 बाँसक पीठ *bānsak pīth*, 814.
 बाँस के कोठी *bāns ke kōṭhī*, 814.
 बासन्घर *bāsgar*, 1320.
 बाँस फूल *bāns phūl*, 978.
 बासन्मती *bāsmati*, 973, 975, 977,
 978, 979.
 बासा *bāsa*, 978, 1236.
 बाँसा *bānsa*, 24.
 बासा पसिन *bāsa pasin*, 978.
 बासी *bāsi*, 1272.
 बाँसी *bānsi*, 1075.
 बासी कुशी *bāsi kūsi*, 1272.

- बाँह *bānh*, 533, 568, 817.
 बाहब *bahab*, 1115.
 बाहा *baha*, 954.
 बाँही *bānhi*, 558.
 बाँहू *bānhu*, 768.
 बिअरन *biahan*, 1121, 1189.
 बिकर्री *bikri*, 1346, 1468a, 1470,
 1472, 1479; Appendix, 14.
 बिकर्री आम *bikri am*, Appendix, 14.
 बिकर्री के भाव *bikri ke bhāv*, 1479.
 बिकौआ *bikaua*, 1346.
 बिकिया *bikhiya*, 1281.
 बिकेया *bikheya*, 1281.
 बिगन्ना *bigral*, 1077.
 बिगन्ना खादिह *bigral hāsīl*, 1077.
 बिगन्नी *bighati*, 1194.
 बिगन्ना *bigha*, 1020, 1495, 1496.
 बिगन्ना *bichra*, 862.
 बिहार *bichār*, 1088.
 बिहा *bichcha*, 856, 878.
 बिहो *bichchi*, 533, 1024.
 बिहरनी *bichharni*, 392.
 बिहरन *bichharab*, 391.
 बिहन्निआ *bichhucatiya*, 1075.
 बिहाखोन *bichhāon*, 637.
 बिहिया *bichhiya*, 772.
 बिहुआ *bichhua*, 196.
 बिहुडी *bichhuti*, 726.
 बिहौतिया *bichhautiya*, 1075.
 बिहौना *bichhauna*, 637.
 बिजन्ध *bijhant*, 776.
 बिजन्मार *bijmār*, 859, 1078.
 बिजन्नी *bijli*, 764.
 बिजाप्रठ *bijāeth*, 767.
 बिजावठ *bijāwath*, 754, 767.
 बिजुली *bijuli*, 767.
 बिजौठा *bijautha*, 754, 767.
 बिटन *bitan*, 233.
 बिट्ठा *bittha*, 652.
 बिठर *bitthai*, 209.
 बिँरा *binra*, 894.
 बिँरुनी *birnri*, 652.
 बिरार *birār*, 798, 818, 862, 982.
 बिँरिया *binriya*, 149, 196, 652, 1096.
 बिँरुआ *binrua*, 652.
 बिआ *binda*, 937.
 बिओ *bindi*, 924.
 बिआ *bitta*, 1489, 1490.
 बिआर *bithār*, 713.
 बिदहनी *bidahni*, 824, 826.
 बिदागरी *bidāgri*, 1294.
 बिदागी *bidāgi*, 1291, 1294.
 बिदाब *bidāb*, 824, 826.
 बिदिह *bidih*, 1090.
 बिदेसी बरन् *bidesi barm*, 1456.
 बिदहनी *bidhkarī*, 1355.
 बिधवा *bidhwa*, 1088, 1279.
 बिन *bin*, 1025, 1085, 1088.
 बिनगिहार *binnihār*, 878.
 बिनगाद् *binhāi*, 856.
 बिनगाओ *binhāmo*, 1095.
 बिना *bina*, 1090.
 बिनाद् *bināi*, 639.
 बिनाव *bināw*, 639.
 बिनावठ *bināwat*, 248, 639.
 बिनिआ *binian*, 877.
 बिनुआ *binua*, 852.
 बिनुआ गोरठा *binua goītha*, 852.
 बिनौठ *binaut*, 639.
 बिन्दी *bindi*, 747.
 बिन्ना *bindha*, 1176.
 बिबाह *bibah*, 1273.
 बिअहती *biyahuti*, 241.
 बिअहती पाखन्नी *biyahuti pālki*, 241.
 बिआज *biyāj*, 1475.
 बिआजू *biyāju*, 1485.
 बिआन *biyān*, 1116.
 बिआना *biyāna*, 1116.
 बिआमार *biyāmār*, 859.
 बिआर *biyār*, 862, 982.

बिबाह *biyāh*, 1194, 1273.
 बिबाह दानी *biyāh dāni*, 1194, 1201, 1273.
 बिबाही *biyāhi*, 1276, 1338.
 बिबाही भात *biyāhi bhāt*, 1338.
 बिबाही *biyāhi*, 1196.
 बिरन्धी *birkhī*, 767.
 बिरन्धीतसरग *birkhotsarg*, 1459.
 बिरन्धियाप्रह *birniyāḍi*, 1076.
 बिरन्धा *birwa*, 1056.
 बिरन्दा *birwāḍi*, 1073.
 बिरन्धरा *birahra*, 660, 1055.
 बिरन्धा *birha*, 1154.
 बिराह *birāh*, 826.
 बिरित *birīṭ*, 1194, 1209, 1209d.
 बिरितद्वार *birīṭdār*, 1209.
 बिरितिहा *birīṭiḥa*, 1209.
 बिरिया *birīya*, 196, 335f, 1055.
 बिरेंटी *birenti*, 767.
 बिलस *bilast*, 1489.
 बिलसा *bilasta*, 637, 1489.
 बिलसस *bilhast*, 1489.
 बिबाप्रती *bilāṭi*, 328, 1021, 1059, 1073.
 बिबाप्रती पट्टा *bilāṭi patua*, 1073.
 बिबाप्रती बैंगन *bilāṭi baingan*, 1073.
 बिलेया *bilaiya*, 175, 183, 1250.
 बिल्ली *billi*, 1250.
 बिशुन *bishun*, 1209a.
 बिशुन चरणन *bishun arpan*, 1209a.
 बिशुन प्रीत *bishun prīṭ*, 1209a.
 बिसन्हाव *bisakhāb*, 1158.
 बिसन्डी *bisti*, 726.
 बिसन्दाही *bismāḍi*, 867.
 बिसन्मिह *bismīl*, 1499.
 बिसन्राँव *bisrāñw*, 1416.
 बिसन्री *bisri*, 646.
 बिसन्वा *biswa*, 1496.
 बिसन्धरा *bisahra*, 1456.
 बिसाखा *bisākha*, 1082.

बिसाही *bisārhi*, 1183.
 बिसार *bisār*, 646.
 बिसारी *bisāri*, 646.
 बिसुखन *bisukhāb*, 1158.
 बिसुन *bisun*, 914, 971, 1203.
 बिसुन चन्स *bisun ans*, 1203.
 बिसुनटिहा *bisunatiya*, 971.
 बिसुन बिरित *bisun pirīṭ*, 914, 971, 1203.
 बिसुकर्मा *biswakarma*, 299.
 बिहड़ *bihar*, 791.
 बिहन्धीया *bihandhoa*, 864.
 बिहन्दा *bihndā*, 856, 859, 862, 982.
 बिहन्तार *bihantar*, 862.
 बिहँसि *bihāñsi*, 1088.
 बिहा *biha*, 1273.
 बिहान *bihān*, 362.
 बिही *bīhi*, 1276.
 बिहौती *bihauti*, 1322.
 बीच *bīch*, 833, 1451.
 बीतक *bīyak*, 1483.
 बीमल *bījhal*, 1074.
 बीट *bit*, 233.
 बीटो *bīto*, 814.
 बीठ *bīṭh*, 814.
 बीठा *bīṭha*, 652.
 बीठो *bīṭho*, 652.
 बीड़ *bīr*, 764.
 बींड़ *bīnr*, 149, 924, 1096.
 बीड़ा *bīra*, 1055.
 बींड़ो *bīnro*, 652.
 बीन *bīn*, 585, 1073.
 बीनन *bīnan*, 639.
 बीबी *bībi*, 1377.
 बीबी के सन्मक *bībi ke sahnak*, 1377.
 बीम *bīm*, 322.
 बीमा *bīma*, 1483.
 बीयड़ *bīyar*, 1121.
 बीया *bīya*, 856, 862, 982, 1057, 1070, 1078, 1189.

- बीबा बे बाबू *biya ke āla*, 1057.
 बीबा बाबू *biya bāl*, 1189.
 बीबा बेंगा *biya bengā*, 1189.
 बीबा मार *biya mār*, 1078.
 बीर *bir*, 409, 965a, 1456.
 बीरी *biri*, 335f, 409, 1272.
 बीबा *biñwa*, 1483.
 बीरहू *bihanr*, 791.
 बीहन *bihan*, 856, 862, 982, 1008,
 1189.
 बुदनाम *buiyām*, 372.
 बुकुषा *bukua*, 1320.
 बुकुषा उद्वार *bukua urā*, 1320.
 बुकी *bukki*, 737.
 बुहारण *bujhārath*, 1485.
 बुहौता *bujhauta*, 1485.
 बुट्टा *butta*, 959.
 बुदुबक *burbak*, 741.
 बुदुवा *burhwa*, 969.
 बुदिषा *burhiya*, 1074.
 बुदुबुदाय *budhudday*, 1084.
 बुनियॉ *buniyān*, 1272.
 बुरज्जी *burji*, 585.
 बुरिबक *buribak*, 394.
 बुरज *buruj*, 399, 402.
 बुरज चाप *buruj khāp*, 402.
 बुरज चाब *buruj khāb*, 402.
 बुलाक *bulāk*, 763.
 बर *bū*, 1458.
 बुजब *būjhab*, 1484.
 बूट *būnt*, 994, 1002.
 बुटी *būti*, 475.
 बुंटी *būnti*, 1003.
 बुदुल *būral*, 1477.
 बुदुल भेले *būral bhelai*, 1477.
 बुड़ा *būra*, 1458.
 बूत *būt*, 724.
 बूत के पगन्गी *būt ke pagri*, 724.
 बुनब *būnab*, 855.
 बुनल *būnal*, 855.
 बेबाक *beāj*, 1475.
 बेबाजू *beāju*, 1485.
 बेबागा *beāga*, 1483.
 बेबाबू *beālu*, 1270.
 बेबंगा *beānga*, 486.
 बेबोपार *beopār*, 1461.
 बेबोंगा *beonga*, 486.
 बेबोंगी *beongi*, 486.
 बेबोतब *beotab*, 1371.
 बेकत *bekat*, 1275.
 बेगुवा *bengua*, 785.
 बेगार *begār*, 844, 1184.
 बेगारी *begāri*, 1184.
 बेजहरा *bejhra*, 959.
 बेडुवा *betua*, 1281.
 बेडिया *betiya*, 1282.
 बेराठी *berāthi*, 1250.
 बेरिया *berīya*, 414.
 बेरिषा *berhiyān*, 1183.
 बेतन्त्री *bentri*, 121.
 बेदामी *bedāmi*, 1043.
 बेधवार *bedhwār*, 566.
 बेनाठी *benāthi*, 1250.
 बेनिया *beniya*, 747, 1272.
 बेनियॉ *beniyān*, 529, 1249.
 बेबाक *bebāk*, 1485.
 बेबाक भैल *bebāk bhāl*, 1485.
 बेमारी *bemāri*, 1175.
 बेयाद *beyāi*, 914.
 बेयापार *beyāpār*, 1461.
 बेरर *berāi*, 959.
 बेररा *berra*, 959.
 बेरहण्डिया *berhatiya*, 1270.
 बेरहिन *berhin*, 1272.
 बेरही *berhi*, 1272.
 बेरहीया *berhiya*, 1272.
 बेराठी *berāthi*, 1250.
 बेरुवा *berua*, 96, 239.
 बेलना *belna*, 346, 457, 628.
 बेलनी *belni*, 611.

बेहानन behwan, 1183.
 बेहहरा behahra, 660, 768, 1055.
 बेहहररी behahri, 660, 1049.
 बेहहररी सॉकी behahri sānoki, 1049.
 बेहोन्हा behonha, 1183.
 बेहौंधन behaundhan, 1183.
 बेहौंधा behaundha, 1183.
 बेहौर behaur, 965h.
 बेहवरा behavra, 1250.
 बेहवहरमत behahargat, 1461.
 बेहवहरिया behahariya, 1481.
 बेहवहार bewhār, 1461.
 बेसन्ना besna, 78.
 बेससिचठ besahiha, 1113.
 बेरन्हा पाँचे behra panche, 1445.
 बेसाकी besakhi, 654.
 बेसाहे besāhai, 1113.
 बेहन्ना पाँचे behra pānche, 1445.
 बेहरी behri, 1303.
 बेहवन्दिवा behwariya, 1461.
 बेहव्वाह behwāl, 1094.
 बे be, 796.
 बेँ ben, 490.
 बेँगा bengā, 486, 785, 862, 982, 1173, 1189.
 बेँच bencha, 1088.
 बेँचो bencho, 1087.
 बे चप्पर be chhappar, 796.
 बेँट bent, 29, 60, 75, 87, 88.
 बेँगा beta, 1451.
 बेँगा का सिर पर सॉँव पैँ बेँ beta ka sir par hānth dhai kan, 1451.
 बेँठन bethan, 889.
 बेँरु benr, 1250.
 बेँरा benra, 1250.
 बेरी beri, 1130.
 बेरु berh, 1148.
 बेरी berhi, 77.
 बेँती benti, 121.
 बेद bed, 1090.

बेदाय bedām, 1002.
 बेदि bedi, 1332.
 बेदि घुमाग्रुय bedi ghumāgru, 1332.
 बेना bena, 1249.
 बेनी beni, 747, 1249.
 बेर ber, 1234.
 बेरा bera, 757, 768, 1234.
 बेरी beri, 1183.
 बेरो bero, 814.
 बेरु bel, 198, 749, 1052.
 बेरुव belan, 498, 595, 628.
 बेसि beli, 154.
 बेसी beli, 154.
 बेँव beñw, 490.
 बेवा bewa, 1279.
 बेसन besan, 1272.
 बेसर besar, 763.
 बेँगनी baingni, 1043.
 बेँठका baithka, 1239.
 बेँठकी baithki, 442, 1320.
 बेँठनी baithni, 623.
 बेँठाचोळ baithāöl, 795.
 बेँठार baithār, 1153.
 बेँतरनी baitharni, 973.
 बेरिया bairiya, 1113, 1135.
 बेरिया गोळ bairiya gol, 1118, 1135.
 बेँसका baiska, 623.
 बेँसको baisko, 623.
 बेँसक्या baissakkha, 1084.
 बेँसनी baismi, 623.
 बेँसाग्रुय baissāēb, 1328, 1333, 1429.
 बेँसाळ baissakh, 1039, 1082.
 बेँसाचोळ baissāöl, 851.
 बेँ बै, 363.
 बेँगन baingan, 1073.
 बेँठ baith, 1113.
 बेँठल baithal, 1076.
 बेँठल हासिल baithal hasil, 1076.
 बेँठे baithe, 568.
 बेँदार baidār, 1214.

बैदिक *baidik*, 1459.
 बैद्य *baidhab*, 1279.
 बैना *baina*, 1113.
 बै बिल बघा *bai bil wapha*, 1482
 बैर *bair*, 1430.
 बैरानी *bairāgi*, 733.
 बैरी *bairi*, 1073.
 बैलट *bailat*, 491.
 बैलठ *bailath*, 491.
 बैल *bail*, 128, 261, 572, 841, 889,
 999n, 1096, 1097, 1113, 1118.
 बैस *bais*, 416, 1343.
 बैसक *baisak*, 78.
 बैसन *baisan*, 623.
 बैसब *baisab*, 1429.
 बैसे *baise*, 1089.
 बैहार *baihār*, 784.
 बोकन्दा *bokra*, 963, 1121.
 बोकन्दा *bokla*, 984, 1031, 1073.
 बोकन्दा बीन *bokla bin*, 1073.
 बोगन्दा *bogda*, 1141.
 बोगन्दा *bogha*, 863, 964, 968.
 बोगिया *bogiya*, 49.
 बोगेड़ा *bogera*, 964.
 बोहनिया *bojhaniya*, 321.
 बोहनिया चौद *bojhaniya haud*, 321.
 बोहनवटार *bojhatāi*, 913.
 बोभार *bojhāi*, 321, 372.
 बोभार के चौद *bojhāi ke haud*, 321.
 बोहन्नी *borhni*, 53, 439.
 बोन *bon*, 844.
 बोनी *boni*, 1185.
 बोरन्सी *borsi*, 1247, 529.
 बोहन्नी *bohni*, 1480.
 बोहन्नी बट्टा *bohni batta*, 1480.
 बोहारब *boharab*, 58.
 बोहनी *boāni*, 855, 863.

बोबल *boāl*, 855.
 बोबार *boāi*, 855.
 बोहन *boin*, 1017.
 बोहन् *boiha*, 1084.
 बोए *boe*, 967, 1085, 1086.
 बोका *boka*, 1121.
 बॉन *bong*, 654.
 बोभा *bojha*, 882, 884, 885, 886,
 913, 1013, 1145, 1194, 1196.
 बोहन *borhan*, 53.
 बोना *bota*, 472, 1131.
 बोनू *botu*, 1121.
 बोनो *boto*, 1121.
 बोहर *bodar*, 951.
 बोनी *boni*, 855.
 बोर *bor*, 1272.
 बोर बोर *bor bor*, 1272.
 बोरस *boras*, 1247.
 बोरा *bora*, 130, 982.
 बोरो *boro*, 980.
 बोली *boli*, 1091.
 बोले *bole*, 1088.
 बोहा *boha*, 1080.
 बोहन्दी *baudandī*, 213.
 बोहा *baua*, 1088.
 बौंका *baunkha*, 32, 768.
 बौड़ी *bauri*, 1499.
 बोघा *baugha*, 858.
 बोघेर *baupher*, 1458.
 बौरा *baura*, 1294.
 बौली *bauli*, 224.
 बौह *bauh*, 1275.
 ब्रह्मन्मोज *brambhroj*, 1426.
 ब्राह्मन् *brāhman*, 1286, 1426.
 ब्राह्मन् के गोड़ हूँ *brāhman ke gor
 chhu kañ*, 1451.
 ब्राह्मन् जेवन्तार *brahman jeonār*, 1426.

॥ भ bh ॥

भदधारा *bhaiara*, 1345.
 भदधारी *bhaiāri*, 1345.

भदधारे *bhaiāre*, 1345.
 भदधारो *bhaichāro*, 1345.

भई *bhain*, 1120.
 भप्र *bhae*, 1026, 1085.
 भच चट्टा *bhakh chatua*, 1076.
 भचड *bhakhhar*, 1078.
 भचड जाप्रब *bhakhhar jāēb*, 1078.
 भखिषाप्रब *bhakhhiyāēl*, 1076.
 भगई *bhagai*, 726.
 भगत *bhagat*, 1453.
 भगन्तार *bhagtāi*, 1453.
 भगतिषा *bhagatiya*, 1453.
 भंगरा *bhangra*, 1075.
 भंगरिषा *bhangariya*, 1075.
 भंगरैषा *bhangraiya*, 1075.
 भगवा *bhagwa*, 726.
 भगाड *bhagār*, 920c.
 भगेखिया *bhagehiya*, 1486.
 भङ्ग *bhankh*, 1074.
 भङ्ग *bhang*, 1036.
 भंजनी *bhanjani*, 363.
 भंजवरिषा *bhanjhariya*, 291, 846.
 भंजवा *bhajha*, 1172.
 भंजावाला *bhānjā wāla*, 846.
 भंजेठ *bhanjeth*, 846.
 भंजेत *bhanjait*, 846.
 भंजीती *bhanjauti*, 846.
 भञ्जा *bhanja*, 846.
 भटकुषाँ *bhatkuān*, 1073.
 भटकोँषा *bhatkoñā*, 1073.
 भटरङ्ग *bhatrang*, 1264.
 भट्टी *bhatti*, 529.
 भट्टा *bhattha*, 312 920c, 1264.
 भट्ठी *bhatthi*, 371, 454, 562.
 भट्ठीदार *bhatthidār*, 371.
 भठाप्रब *bhathāēb*, 857.
 भठौनी *bhathāuni*, 1006.
 भठारी *bhandāri*, 197.
 भड्डर *bhaddar*, 1087.
 भड्डरि *bhaddari*, 1087, 1088.
 भड्डक *bharkachh*, 726.
 भड्डका *bharkāchh*, 726.

भड्डकू *bharkūi*, 920b.
 भड्डभूजा *bharbhūja*, 433.
 भड्डकी *bhānrūki*, 920b.
 भड्डा *bhanta*, 1073.
 भड्डार *bhandār*, 1433.
 भटवान *bhatwān*, 1341.
 भटवानी *bhatwāni*, 1341.
 भटार *bhatār*, 1088, 1274, 1279.
 भटुषा *bhatua*, 1071.
 भटा *bhatta*, 252.
 भठ्ठे *bhathkhai*, 1286.
 भठ्ठकूषाँ *bhatkhūān*, 920c.
 भड्डर *bhadr*, 1418.
 भड्डर करारब *bhadr karāeb*, 1418.
 भड्डवी *bhadvi*, 996.
 भडेषा *bhadaiya*, 965, 1016.
 भड्डपड *bhadrapad*, 1082.
 भड्डसा *bhansa*, 1248.
 भड्डसा घर *bhansa ghar*, 1248.
 भड्डसार *bhansār*, 435.
 भड्डसारी *bhansāri*, 434.
 भड्डका *bhabhka*, 713.
 भड्डरा *bhabhra*, 994.
 भड्डरा *bhambhra*, 1249.
 भड्डरी *bhabhri*, 1272.
 भड्डरा *bhamra*, 1249.
 भडे *bhaye*, 1991.
 भर *bhar*, 262, 867, 1010, 1092, 1174.
 भरक *bharkachh*, 726.
 भरका *bharka*, 1074.
 भरकाषा *bharkāha*, 1098.
 भरकी *bharki*, 1074.
 भर खुरपी सोहब *bhar khurpi sohab*, 867.
 भर जाप्रब *bharjāēb*, 1174.
 भर ठेडना *bhar thehuna*, 1010.
 भरन्ता *bharta*, 1272.
 भरन्ती *bharti*, 372.
 भरन्तीना *bhardāna*, 842.

भरण *bharan*, 920c.
 भरणथ *bharnath*, 1251.
 भरणा *bharna*, 731, 1251, 1477,
 1482.
 भरणी *bharni*, 1082.
 भरन्त *bharant*, 1091.
 भरत *bharab*, 1388, 1390.
 भरन्नाङ्क *bharbhānr*, 1075.
 भरत *bharat*, 850, 915.
 भरन्वन *bharban*, 833.
 भरन्सलिया *bharsaliya*, 842.
 भरन्साँ *bharsāin*, 434, 435.
 भरान्त *bharānth*, 1251.
 भराना *bharāna*, 731.
 भरानी *bharāni*, 179.
 भरान *bharāw*, 731.
 भरानत *bharāwat*, 475.
 भरिच *bharith*, 666.
 भरुका *bharuka*, 713.
 भरुकी *bharuki*, 713.
 भरे *bhare*, 1087.
 भरेत *bhareth*, 1251.
 भरेथ *bharait*, 1251.
 भरेया *bharaiya*, 801.
 भँवन्रा *bhāñwara*, 1074.
 भँवन्री *bhāñwari*, 1332.
 भवानो *bhawāni*, 1456.
 भवानी *bhawāni*, 1249.
 भसनी *bhasni*, 831.
 भसन *bhasam*, 414.
 भसल *bhasal*, 920c.
 भसुराही *bhasurāhi*, 786.
 भँ *bhān*, 1085.
 भाइ *bhāi*, 1089.
 भाङ्कुर *bhākur*, 1458.
 भाँक *bhānk*, 1074.
 भाँकी *bhānki*, 1074.
 भाँग *bhāng*, 1036.
 भागर *bhāgar*, 788.
 भागलपुर *bhāgalpūr*, 1486.

भाँज *bhānj*, 291, 363, 846, 872, 1205.
 भाँजा *bhānja*, 872.
 भाँजा सिरे *bhānja sire*, 291.
 भाजी *bhāji*, 1001.
 भाँजो *bhājyo*, 846.
 भाँडा *bhānta*, 1073.
 भाँडिन *bhāntin*, 965i.
 भाड *bhāth*, 802, 901.
 भाठी *bhāthi*, 1264.
 भाँङ्क *bhānr*, 713.
 भाँङ्क *bhānra*, 138.
 भाँङ्का *bhānra*, 136, 138, 140, 467,
 713.
 भाँङ्की *bhānri*, 495.
 भात *bhāt*, 963, 990, 1084, 1087,
 1272, 1286, 1338.
 भादब *bhādab*, 1087.
 भादों *bhādon*, 1082, 1087, 1088,
 1092.
 भाँधी *bhānhi*, 414.
 भाधी *bhāthi*, 414, 510, 554, 560,
 545.
 भाहन *bhān*, 1087.
 भाहानस *bhānas*, 1248, 1268.
 भाहानस घर *bhānas ghar*, 1248.
 भाह *bhār*, 435, 444.
 भाहारा *bhāra*, 1483.
 भाहारी *bhāri*, 657, 737.
 भाहरो *bhāro*, 444.
 भाहल *bhāl*, 972.
 भाहल सरी *bhāl sari*, 972.
 भाहला *bhāla*, 102.
 भाहो *bhāo*, 1479.
 भाह के भाह *bhāo ke bhāo*, 1479.
 भाँव *bhāñwar*, 912, 1194, 1196,
 1332.
 भावन्ही *bhāohi*, 902, 1198, 1221, 1225.
 भाँवाँ डेरा *bhāwān dera*, 1110.
 भास *bhās*, 789, 923.
 भासे *bhāse*, 834.

- भिच्चा *bhichchha*, 1203.
 भिठगारा *bhithgara*, 1000.
 भिठारा *bhithara*, 811.
 भिष्ठा *bhinda*, 917, 1050.
 भिन्दी *bhindi*, 1073.
 भित्तभेड़ा *bhitbhera*, 1256.
 भितभेरा *bhitbhera*, 363.
 भिरंगी *bhirngi*, 999.
 भिरुकी *bhirukhi*, 1173.
 भिलोर *bhilor*, 1183.
 भिलारि *bhillari*, 1084, 1085.
 भीख *bhikh*, 1203.
 भीजे *bhije*, 737.
 भीजे *bhinjai*, 1087.
 भीठ *bhith*, 784, 802, 811, 1050.
 भीठा *bhitha*, 784, 793, 811.
 भीठो *bhitho*, 784.
 भीड़ *bhinr*, 917.
 भीम *bhit*, 1235, 1251.
 भीम घर *bhit ghar*, 1235.
 भीता *bhita*, 836, 1251.
 भीस *bhis*, 785.
 भुषापाग *bhuapag*, 1272.
 भुँषोखरी *bhuñakhari*, 612.
 भुर चम्पा *bhuin champa*, 585b.
 भुरसा *bhuila*, 1074.
 भुरली *bhuili*, 1074.
 भुरलोट *bhuilot*, 1263.
 भुरसीकर *bhuinsikar*, 966b.
 भुगन्तान *bhugtān*, 1487.
 भुचप्पा *bhuchappa*, 585b.
 भुचम्पा *bhuchampa*, 585b.
 भुजग्ना *bhujna*, 1272.
 भुँजग्ना *bhunjna*, 433.
 भुँजग्नाही *bhunjnāhi*, 56, 439.
 भुजबगरा *bhunjabra*, 1941.
 भुटका *bhutka*, 1073.
 भुटा *bhutta*, 984.
 भुङ्की *bhurki*, 1253.
 भुङ्की *bhunki*, 612.
 भङ्गा *bhunra*, 1107.
 भुङ्गिया *bhuriya*, 612.
 भुँङ्गिया *bhuñriya*, 956.
 भुष्ठा *bhunda*, 1107.
 भुष्ठी *bhundi*, 729, 1173.
 भुष्ठी *bhundo*, 729.
 भुत्तिएलाह *bhutiailah*, 356.
 भुन्दो *bhundo*, 612.
 भुसन्तान, *bhubhtān*, 1485, 1487.
 भुसन्तान हो गैस *bhubhtān ho gait*,
 1485.
 भुरका *bhurka*, 713.
 भुरकी *bhurki*, 713.
 भुरफुट *bhurphut*, 922.
 भुररी *bhurri*, 1074.
 भुरली *bhurli*, 1005, 1074.
 भुरहा *bhurha*, 922.
 भुरियाँ *bhuriyān*, 431.
 भुरिला *bhurila*, 1074.
 भुरिली *bhurili*, 1074.
 भुरा *bhurra*, 1014.
 भुसकार *bhuskār*, 895.
 भुसकारी *bhuskāri*, 895.
 भुसकार *bhuskār*, 895.
 भुसघर *bhusghar*, 895.
 भुसगा *bhusna*, 1023.
 भुसनी *bhusni*, 785.
 भुसरङ्गा *bhusaranga*, 1264.
 भुँसडस *bhuñsahul*, 895.
 भुसुरिया *bhusuriya*, 1264.
 भुसुरी *bhusuri*, 786.
 भुँसौर *bhunsaur*, 895.
 भुसौस *bhusaul*, 895.
 भुसौस घर *bhusaul ghar*, 895.
 भुसुसुसुगा *bhusbhulba*, 895.
 भुष्ठा *bhussa*, 894, 990, 1004, 1145.
 भुष्ठा *bhūa*, 284, 1071, 1074.
 भुष्ठा *bhūja*, 1272.
 भुँजा *bhūja* 433, 1272.
 भुँड *bhanr*, 922.

- भूडा *bhūna*, 1107.
 भूदी *bhūndri*, 729.
 भूत *bhāt*, 1457, 1458.
 भूमल *bhūnal*, 963, 1272.
 भूमलखिचन्दी *bhūnal khichri*, 963, 1272.
 भूप *bhūp*, 1073.
 भूप सेम *bhūp sem*, 1073.
 भूमि *bhūmi*, 1203.
 भूमि गनेस *bhūmi ganes*, 1203.
 भूर *bhūr*, 156, 922.
 भूरा *bhūra*, 1014, 1052, 1071.
 भूला *bhūla*, 1132.
 भूला जारल *bhula jāil*, 1132.
 भूष *bhūṣ*, 994, 995, 997, 1092.
 भूषा *bhūṣa*, 894, 895, 990, 994, 995, 1004, 1145.
 भूषा *bhūṣa*, 894, 1004, 1145.
 भूषा घर *bhūṣā ghar*, 895.
 भूषी *bhūṣi*, 990, 1183.
 भूषी *bhūṣi*, 894.
 भेकरी *bhekhri*, 1183.
 भेनरिया *bhengariya*, 1075.
 भेनवाँस *bhentwāns*, 999, 1076.
 भेनकाबर *bhenrkābar*, 973.
 भेनघुरे *bheṅrdhurai*, 1150.
 भेनगा *bhenra*, 1074, 1104.
 भेनड़ी *bhenṛāri*, 848.
 भेनरिहार *bhenrihar*, 488, 1150.
 भेनरिहार *bheṅrihār*, 1150.
 भेनरिहारा *bheṅrihāra*, 1150.
 भेनारी *bhenāri*, 848.
 भेनरा *bhemra*, 1074.
 भेलाह *bheiahūn*, 604.
 भेले *bhelai*, 1477.
 भेजिये *bhejiye*, 655.
 भेंट *bhent*, 999.
 भेंद *bheṅr*, 1104, 1123.
 भेंडा *bhenra*, 1074, 1123.
 भेंदिक *bheṅrik*, 1123.
 भेंदिक चहा *bhenrik bachcha*, 1123.
 भेंदी *bhenri*, 851, 1123.
 भेंदी बेसाबोस *bhenri baisāol*, 851.
 भेंदी हिराबोस *bhenri hirāol*, 851.
 भेंदो *bheṅro*, 1123.
 भेर *bher*, 832, 1214.
 भेल *bhel*, 864, 957, 987, 990.
 भेली *bheli*, 1014.
 भेबाँट *bhaibānt*, 1214.
 भेसबेट *baislet*, 965j.
 भेसाण *bhainsāḅ*, 1115.
 भेसाँटा *bhainsāuta*, 1139.
 भेसाँटा *bhainsautha*, 1139.
 भेसाँटा *bhainsōḅḅa*, 1151.
 भेचक *bhaiyak*, 1446.
 भेचा *bhaiya*, 1088, 1214.
 भेचा बाँट *bhaiya bānt*, 1214.
 भेरब *bhairab*, 1456.
 भैरो *bhairō*, 1456.
 भैल *bhail*, 957, 1485.
 भैव *bhaiwadh*, 1214.
 भेंस *bhains*, 1120.
 भेंसा *bhainsa*, 1120.
 भेंसी *bhainsi*, 1120.
 भोकसवा *bhokasua*, 1458.
 भोकिला *bhokila*, 954.
 भोकौसा *bhokaua*, 818.
 भोगिला *bhogila*, 1016, 1019.
 भोचरी *bhochri*, 1016, 1019.
 भोजनी *bhojni*, 1197, 1201, 1435.
 भोजनरी *bhojāri*, 713.
 भोंटिया *bhontiya*, 646.
 भोथरा *bhothra*, 637.
 भोरणा *bhorha*, 984.
 भोराह *bhorāh*, 984.
 भोरियाण *bhonriyāḅ*, 1132.
 भोसाँला *bhoṣāula*, 895.
 भोग *bhog*, 972, 975.
 भोज *bhoj*, 1341, 1345, 1426, 1435.
 भोर *bhor*, 1217.
 भोर *bhor*, 1026, 1076.

भौरा *bhoira*, 1249.
 भोसा *bhosa*, 1183.
 भोक्ता *bhaukatia*, 913.
 भौरकाली *bhaunrkali*, 595.
 भौरिया *bhaunriya*, 828.
 भौरा *bhaurāñ*, 1110, 1113.
 भौरा डेर *bhaurāñ ter*, 1110, 1113.
 भौरा डेर *bhaurāñ der*, 1110.

भौरा *bhaunki*, 49, 442.
 भौरा *bhaunta*, 898.
 भौरा *bhauntho*, 252.
 भौरा *bhaunta*, 252.
 भौरा *bhaunti*, 346.
 भौरा *bhaunr kali*, 261.
 भौरा *bhaunri*, 1194, 1332.

॥ म m ॥

मं *mañ*, 1234.
 मण्डा *maëda*, 1272.
 मकर *makai*, 983, 984, 1183.
 मकर के दाँत *makai ke dānt*, 1183.
 मकरा *makra*, 1075.
 मकरना *makna*, 1382.
 मकरपल *makphāl*, 1481.
 मकरा *makra*, 993, 1183.
 मकरा *makri*, 7, 331, 346, 375, 585,
 587, 933, 940, 1250.
 मकान *makān*, 1234.
 मकारबौर *makārbir*, 299, 1456.
 मकुना *makuna*, 1129.
 मकुनी *makuni*, 1272.
 मकुन्दी *makundi*, 1272.
 मकुन्दी दाना *makundi dāna*, 1272.
 मकैया *makaiya*, 983.
 मकोय *makoe*, 1073.
 मक्खन *makghan*, 1166.
 मखदुमाना *makhdumāna*, 1441.
 मखदूम शाह *makhdūm shāh*, 1441.
 मखाना *makhāna*, 1419.
 मगजी *magji*, 748.
 मंगतीका *mangtika*, 762.
 मंगनी *mangni*, 912, 1196, 1366,
 1483.
 मंगनी चंगनी *mangni changni*, 1483.
 मंगरा *mangra*, 161, 713, 1074,
 1262.

मंगरी *mangri*, 1257.
 मगवासी *magvāsi*, 335c.
 मगही *maghi*, 1049.
 मग्घा *maggha*, 1082, 1084, 1087.
 मग्घा *maghra*, 805, 818.
 मग्घा चास *maghra chās*, 818.
 मग्घाट *maghwat*, 818.
 मग्घा *magha*, 1086.
 मग्घा *maghār*, 805, 818.
 मग्घा जोतव *maghār jotab*, 818.
 मग्घाट *maghāt*, 805.
 मग्घार *maghār*, 798, 805.
 मग्घुवा *maghua*, 805.
 मङ्गर *mangar*, 152, 161.
 मखान *machān*, 70, 233, 327, 429,
 890.
 मचिया *machiya*, 632.
 मचोला *machola*, 632.
 मच्छर *machchhar*, 1183.
 मच्छक *machhkachh*, 1419.
 मच्छक ला *machhkachh la*, 1419.
 मच्छरिया *machhariya*, 764.
 मच्छरिया *machhaliya*, 764.
 मच्छली *machhli*, Appendix, 14.
 मच्छुवा *machhua*, 232.
 मच्छती *machhaiti*, 1075.
 मजना *majna*, 362.
 मजनी *majni*, 575.
 मजरी *majri*, 1074.

- मजिह majil, 1416.
 मजिह ले जानिहार majil le jānihār,
 1416.
 मजिहिया majiliha, 1416, 1417.
 मजुसी majusi, 322.
 मजूर majūr, 420, 1184.
 मजूरा majūra, 293, 842.
 मजूरी majūri, 1185.
 मज्जमी majhni, 1341.
 मज्जवा majhwa, 332.
 मंजवारत manjhāra, 19.
 मज्जोतर majhotar, 33.
 मंजोला manjholā, 422.
 मंजोली manjhōli, 148, 482.
 मंजोला manjhautā, 252.
 मज्जोतर majhautar, 33.
 मंजो manji, 507.
 मज्जा manjha, 179, 889.
 मज्जार manjhar, 1098.
 मटका matka, 713, 1173, 1458.
 मटकी matki, 83.
 मटकुरी matkuri, 139, 465.
 मटकुरी matkūhi, 139.
 मटकोरवा matkorwa, 1306, 1311.
 मटकोर matkor, 578.
 मटखना matkhana, 578.
 मटखना matkhabha, 578.
 मटखन matkham, 578.
 मटपर matpar, 1247.
 मटमहनी matmahni, 143.
 मटर matar, 1000.
 मटरा matra, 959.
 मटरी matri, 1272.
 मटरो matro, 1001.
 मटरी सग matro sḡ, 1001.
 मटथा matha, 792.
 मटिखान matikhān, 129, 578.
 मटिगर matigar, 786.
 मटिया matiya, 572.
 मटिहार matiyār, 578, 786, 802.
 मटिहार बाँगर matiyār bāngar, 802.
 मटिहार बीठ matiyār bhith, 802.
 मटिहम matiham, 414.
 मटुका matuka, 83, 372, 696, 713.
 मटुकी matuki, 308.
 मटोर mator, 45, 1052.
 मट्टा mattha, 1166.
 मठ math, 1234.
 मठगर mathgar, 1161.
 मठजाउर mathjaur, 1272.
 मठना mathna, 552.
 मठरना matharna, 499.
 मठरनी matharni, 523.
 मठार mathār, 499.
 मठादा mathdha, 1161.
 मठादी mathāhi, 1161.
 मठिया mathiya, 757, 768, 1234.
 मठिहार māthiyār, 1161.
 मट्टा mattha, 1272.
 मट्टर marai, 72, 407, 879.
 मट्टर mātṛai, 1234.
 मट्टर marar, 488.
 मट्टर manrar, 1450, 1452.
 मट्टर marar, 1075.
 मट्टर māṛrar, 1217.
 मट्टरा marra, 603.
 मट्टरी marri, 585a.
 मट्टरो marro, 268.
 मट्टरच manricanē, 1201.
 मट्टवा marwa, 1051.
 मट्टवा manrwa, 1307, 1355.
 मट्टरका marsatka, 1272.
 मट्टरी marhi, 1307.
 मट्टिया mariya, 523.
 मट्टुवा marua, 362, 877, 990, 1257.
 मट्टुवा māṛrua, 990, 1257.
 मट्टुवाटी maruati, 1183.
 मट्टुका maruka, 1234. ✽
 मट्टेर manrer, 1075.
 मट्टैया maraiya, 394.

महुवा *marhua*, 1307, 1308, 1309,
 1310, 1311, 1322, 1326, 1327,
 1828, 1332.
 महुची *marhhi*, 1234.
 मणप *mandap*, 1307.
 मन्तर *mantar*, 1000.
 मन्था *mantha*, 1272.
 मन्दा *manda*, 823, 955.
 मन्तो ज्योत *manço jot*, 828.
 मण्डू *mandu*, 1183.
 मण्डू के नारा *mandu ke nara*, 1183.
 मति *mati*, 1113.
 मथई *mathai*, 142.
 मथनी *mathni*, 144, 541, 895,
 1251.
 मथबोजा *mathbojha*, 886.
 मथार *mathai*, 142.
 मथानी *mathani*, 769.
 मथार *mathar*, 941.
 मदक *madak*, 1033.
 मदत *madat*, 1201.
 मंदरा *mandra*, 203, 204.
 मद्दाम *madān*, 1451.
 मद्दियान *madiyān*, 1126.
 मधनारी *madhnari*, 372.
 मध *man*, 790, 1263, 1383, 1498.
 मन्कांटा *mankānta*, 640.
 मन्कोडी *mankorki*, 1098.
 मन्काणी *mankauni*, 1045.
 मन्कणप *mankhap*, 903, 1221.
 मन्कणम *mankham*, 275.
 मन्गो *mango*, 1005.
 मन्गार *manjhāi*, 341.
 मन्चलब *manchalab*, 1399.
 मन्ठीका *manthika*, 903, 1221.
 मन्पई *manpai*, 914.
 मन्पौषा *manpaua*, 914.
 मन्वॉ *manwān*, 808, 1016.
 मन्सरा *mansara*, 978.
 मन्सरी *manasari*, 972.
 मन्सा राम *mansa rām*, 1456.

मन्हर *manhar*, 1140.
 मन्हुण्डा *manhunda*, 903, 1221.
 मन्धानो दानो *mandno dāno*, 1456.
 मन्किथम *maniktham*, 275.
 मन्किथम *manikthamh*, 1256.
 मन्हार *manihār*, 561.
 मनी *mani*, 903, 1185, 1221.
 मनी बन्दोबस्त *mani bandobast*, 903,
 1221.
 मनुस *manus*, 1026.
 मनुसदेबा *manusdeba*, 1458.
 मनुस देव *manus deo*, 1456.
 मनोरी *manori*, 766.
 मन्त्र *mantr*, 1457.
 मन्त्री पूजा *mantri pūja*, 1308.
 मन्हर *mamhar*, 1298, 1300.
 ममुहर *mamuhar*, 1300.
 ममोर्नी *mamorni*, 325.
 मरई *marai*, 1234.
 मरकन *markan*, 1262.
 मरकहा *markaha*, 1098.
 मरकी *marki*, 912.
 मरकी गरकी *marki garki*, 912.
 मरकहा *markhanda*, 1098.
 मरकन *markhan*, 1098.
 मरकनो *markhanno*, 1098.
 मरकहा *markhāh*, 1098.
 मरघट *marghat*, 1418.
 मरघटी *marghatti*, 1418.
 मरचिरीया *marchiriya*, 1458.
 मरचुवा *marachhuva*, 1397, 1400.
 मरजाद *marjād*, 1290, 1339.
 मरजाद राख *marjād rākhāb*, 1339.
 मरतबान *martabān*, 713.
 मरतवान *martawān*, 713.
 मरथम *marthamh*, 258, 275.
 मरद *marad*, 1274.
 मरदाना *mardāna*, 1254.
 मरदानी *mardāni*, 726, 1254.
 मरदावा *mardāwa*, 1274
 मरन *maran*, 789.

मरुवट *marvat*, 1209a.
 मरुविष्ठा *marhinna*, 1074, 1077.
 मरुवेजा *marhena*, 1077.
 मरा *mara*, 1076, 1077.
 मरादल *marāil*, 1004.
 मराप्रल *marāil*, 1076.
 मराह *marāchh*, 1397, 1400.
 मरिखर *marikhar*, 33.
 मरिषा *maricha*, 1073.
 मरिषा *mariya*, 233, 397, 410, 523,
 541, 552.
 मरी *mari*, 1074, 1094.
 मरुषा *marua*, 1252, 1257.
 मरुका *maruka*, 71, 879.
 मरेषा *mareya*, 233, 523.
 मरेन *maren*, 1075.
 मरै *marai*, 1234.
 मरोषा *marochha*, 1397.
 मरौषती *marauati*, 1217.
 मरौटी *marauti*, 1209c.
 मर्रा *marra*, 72.
 मलङ्कङ्गमी *malkangmi*, 1045.
 मलङ्कठी *malkāthi*, 347, 348, 351.
 मलङ्कौनी *malkauni*, 1045.
 मलङ्गिया *malangiya*, 680.
 मलङ्गिया थारी *malangiya thāri*, 680.
 मलङ्गुजारी *malgujāri*, 1207, 1220.
 मलङ्ग *malang*, 235.
 मलङ्गदिया *maldahiya*, 1057.
 मलङ्गदिया कनकपुरिया *maldahiya
 kanakpuriya*, 1057.
 मलङ्गानो *maldāno*, 1456.
 मलङ्गार *malmar*, 1477.
 मलङ्गास *malmas*, 1081.
 मलङ्गा *mahwa*, 24, 238, 663, 713,
 719, 1257.
 मलङ्गी *malsi*, 663.
 मलार *malāi*, 1165.
 मलार *malāh*, 1456.
 मलिकथम *maliktham*, 258.
 मलिकथम *malikthambh*, 1256.

मलिकार *malikāi*, 1201.
 मलिकार चुटकी *malikāi chutki*,
 1201.
 मलिषा *maliya*, 663, 701, 713.
 मलीदा *malida*, 1384.
 मलुषा *malua*, 1023.
 मलौ *malau*, 110.
 मलिषा *malhiya*, 701.
 मवेशी *maveshi*, 1094.
 मसक *masak*, 655, 720.
 मसकली *maskali*, 602.
 मसतूल *mastul*, 238.
 मसन्द *masnad*, 637.
 मसर *masar*, 959.
 मसाहू *masārhu*, 742.
 मसांत *masānt*, 1499.
 मसान *masān*, 1456.
 मसालची *masālchi*, 720.
 मसालदार *masāldār*, 1023.
 मसाला *masāla*, 423, 1119, 1267.
 मसाह *masāh*, 824, 981.
 मसाह करव *masāh karab*, 981.
 मसियार *masiyār*, 1087.
 मसी *masi*, 1183.
 मसुरिया *masuriya*, 985.
 मसुरिया जनेर *masuriya janer*, 985,
 987.
 मसुरी *masuri*, 998.
 मसूर *masūr*, 998.
 मसूल *masul*, 1488.
 महकार *mahkār*, 299.
 महकार बीर *mahkār bir*, 299.
 महकावा *mahkava*, 1023.
 महताव *mahtāb*, 585.
 महताबी *mahtābi*, 585.
 महतोषाडा *mahtoāra*, 1217.
 महतोन *mahton*, 1217, 1288, 1450,
 1452.
 महथिन दाह *mahtthin dāi*, 1456.
 महदेवा *mahdeva*, 19, 938.
 महन *mahan*, 142, 251, 256, 273.

महान भोग *mahan bhog*, 1272.
 महानिया *mahaniya*, 321.
 महानिया हौद *mahaniya haud*, 321.
 महानी *mahni*, 144.
 महप्पा *mahappa*, 247.
 महाब *mahab*, 142.
 महामाया *mahmāya*, 1175, 1456.
 महार *mahar*, 1349, 1362, 1363.
 महारदार *mahardār*, 373.
 महरन *mahrān*, 1161.
 महरम *mahrām*, 744.
 महरार *mahrāi*, 1154.
 महरू *mahrū*, 1033.
 महल *mahal*, 142.
 महसूल *mahsūl*, 1488.
 मँहा *mañha*, 995.
 महार *mahāi*, 142, 321.
 महार के हौज *mahāi ke hauj*, 321.
 महाजन *mahājan*, 1456, 1461, 1481.
 महाजनी *mahājni*, 1461.
 महाजाल *mahājāl*, 646.
 रुहाड़ा *mahāra*, 138.
 मँहाड़ा *mañhāra*, 143.
 महादे *mahāde*, 893.
 महादेवो *mahādeo*, 19.
 महादेव *mahādeb*, 893, 1456.
 महादेवा *mahādewa*, 19, 938.
 महान *mahān*, 144, 1450.
 महाबामन *mahābābhan*, 1425.
 महाबीर *mahābīr*, 1456.
 मँहा मूंग *mañha mūng*, 995.
 महार *mahār*, 912.
 महाल *mahāl*, 1499.
 महि *mahi*, 1087.
 महिनवारी *mahinwāri*, 1185.
 महिना *mahina*, 1081.
 महिना *mahinna*, 1081, 1185.
 महिया *mahiya*, 1015, 1161.
 महियाउर *mahiyaūr*, 1272.
 महिस *mahis*, 1120.

महिसा *mahisa*, 1120.
 महिची *mahisi*, 1120.
 मही *mahi*, 142, 1272.
 महीना *mahina*, 1081.
 महुक्क *mahuak*, 1338.
 महुवर *mahuar*, 1135, 1272.
 महुवा *mahua*, 372, 1045.
 महुल *mahul*, 1135.
 महुलका *mahulakha*, 1135.
 महु *mahu*, 1045.
 महेर *maher*, 1272.
 महेला *mahela*, 1119.
 महोनी *mahonni*, 144.
 माह *māi*, 1433, 1456.
 माई *māin*, 639.
 मारन *māin*, 639.
 माउग *māug*, 1275.
 माँचो *māñon*, 1458.
 माख *mākh*, 1084.
 माँग *māng*, 235.
 माँगन *māngan*, 912, 1198.
 माँगनी *māngni*, 1201.
 माँगी *māngi*, 235, 335c.
 माँगे *mānge*, 1025.
 माघ *māgh*, 1082, 1092.
 माघी *māghi*, 818.
 माघी चास *māghi chās*, 818.
 माँच *mānch*, 70, 429.
 माँची *mānchi*, 182.
 माँजन *mānjan*, 362.
 माँजी *mānji*, 507.
 माजूम *mājūm*, 1036.
 माछी *māchhi*, 990.
 माँची *manchhi*, 1074.
 माँज *mānjh*, 1248.
 माँजघर *mānjghar*, 1248.
 माँजा *mānjha*, 179, 214, 224, 195,
 279, 362, 431, 611, 933, 1368,
 1379.
 माँजी *mānji*, 236, 507.

माठ *māt*, 77, 83, 310, 372, 505.
 माँठ *mānt*, 505, 713.
 माटी *māti*, 1089, 1306.
 माठ *māth*, 505, 1161.
 माठा *mātha*, 1161, 1166, 1272.
 माह *mār*, 991.
 माँह *mānr*, 362, 1272.
 माहब *mārab*, 1051.
 माहा *māra*, 630, 1178.
 माहा डडो *māra phulki*, 1178.
 माहो *māro*, 1051.
 माँहो *mānro*, 1051, 1234, 1307.
 माहा *mārha*, 991.
 माँहा *mānrha*, 991.
 माता *māta*, 1440, 1456.
 माता दाँर *māta dāi*, 1456.
 मात्रिक *mātrik*, 1298.
 माँथ *mānth*, 9, 941, 1251.
 माथा *mātha*, 335c.
 माँथा *mānthā*, 9, 408.
 माँदर *māndar*, 259, 271.
 माहब *mādhāb*, 688.
 माहब सिङ्घी *mādhāb singhi*, 688.
 माहवा *mādhwa*, 975.
 मान *mān*, 849.
 मानन्जन *mānjan*, 1450, 1452.
 मानिकन्धम *māniktham*, 275.
 मनिक्कम *mānikham*, 275.
 माफ *māph*, 1217, 1230.
 माफो *māphi*, 912, 1209b, 1217.
 मामस *māmas*, 788.
 मायूँ *māyūn*, 1368.
 मार *mār*, 655, 1078, 1085, 1120.
 मारताँड *mārtaul*, 388, 397, 589.
 मारब *mārab*, 1098, 1246.
 मारल *māral*, 859, 1004, 1011.
 मारल गेल *māral gel*, 1004.
 मारसा *mārsa*, 1074.
 मारा *māra*, 1072.
 मारि *māri*, 1272.

मारी *māri*, 726 (note).
 मारे *māre*, 1089.
 माळ *māl*, 324, 347, 972, 973,
 1028, 1029, 1094, 1202, 1221,
 1272, 1456, 1488.
 माळगुजारी *mālgujāri*, 1207, 1214.
 माळजादी *māljādi*, 1183.
 माळ जाळ *māl jāl*, 1094.
 माळ जडो *māl jhari*, 323.
 माळ देची *māl dehi*, 973.
 माळ पूसा *māl pāsa*, 1272.
 माळ भोग *māl bhog*, 972.
 माळ मेज *māl mej*, 324.
 माळवा *māhwa*, 1087.
 माळा *māla*, 24, 566, 663, 755,
 765, 781, 1257, 1354.
 माळिक *mālik*, 1208.
 माळी *māli*, 24.
 माळ *māl*, 347.
 मास *mās*, 1081, 1086, 1087, 1089.
 माँस *māns*, 1081, 1085.
 मास कलदी *mās kalāi*, 996.
 मासा *māsa*, 1498, 1499.
 मासी *māsi*, 1043.
 माँह *mānh*, 1248.
 माँह घर *mānh ghar*, 1248.
 मापी *māpi*, 1232.
 माँपी *mānpi*, 639.
 मिजनी *mijni*, 887.
 मिजरा *mijra*, 1019.
 मिडिया *mitiya*, 713.
 मिडो *mitti*, 786, 1429, 1431.
 मिडि देव *mitti deb*, 1429, 1431.
 मिठार *mithāi*, 1014, 1440.
 मिठुर *mithur*, 1163.
 मिटो *mitti*, 1487.
 मिन्हा *minhai*, 1209b.
 मिमियार *mimiyāi*, 1045, 1458.
 मिमियार के तेल *mimiyāi ke tel*, 1045,
 1458.

मिवादी *miyādi*, 1487.
 मिर्गिदाह *mirgiddāh*, 1082.
 मिरगंसिरा *mirgsira*, 1082, 1084.
 मिरगी *mirgi*, 1177.
 मिरचा *mircha*, 1073.
 मिरचाह *mirchāi*, 1073.
 मिरजाई *mirjai*, 728, 1272.
 मिरजापुरी *mirjāpuri*, 680.
 मिरतवान *mirtawān*, 713.
 मिरचा *mirča*, 507.
 मिरसिकार *mīrsikār*, 381.
 मिरारब *mirāib*, 1332.
 मिरिच *mirich*, 1073.
 मिसकियत *milkiyat*, 1207.
 मिसनी *milni*, 1339.
 मिसल *milab*, 1343.
 मिसा *mila*, 1485.
 मिसाप्रब *mīlādeb*, 1343.
 मिसान *milān*, 1485.
 मिसाप *milāp*, 1159.
 मिसा लेब *mīlā leb*, 1485.
 मिसावा *mīlāwa*, 1339.
 मिसिह *mīhī*, 282.
 मिसौना *mīlāuna*, 575.
 मिसतिरी *mīstīri*, 389.
 मिसरी *mīsi*, 1014.
 मिसिरी *mīsi*, 1062.
 मिसिरी कन *mīsi* *kan*, 1062.
 मिसर *mīstar*, 427.
 मिसिरी *mīstīri*, 420.
 मिसी *mīsi*, 1384, 1483.
 मिसतर *mīhtar*, 1197.
 मीठा *mītha*, 372, 1365.
 मीठा चाउर *mītha chāur*, 1365.
 मीठी *mīthī*, 1272, 1377.
 मीठी कंदूरी *mīthī kandūri*, 1377.
 मीठी पूरी *mīthī pūri*, 1272, 1377.
 मीड़ा *mīra*, 894.
 मीन *mīn*, 990.
 मीची *mīyan*, 1376.

मीर फसुला *mīr phāiula*, 1456.
 मील *mīl*, 1492.
 मीलन *mīlan*, 1339.
 मीहाँ *mīhān*, 889.
 मीहाँ *mīhān*, 889.
 मुचल *mūal*, 1077.
 मुचला *mūala*, 414.
 मुषार *mūār*, 1074, 1077.
 मुसल *mūil*, 1118.
 मुका *mukka*, 1249, 1253.
 मुकसुध *mukhsudh*, 1046.
 मुकसुधि *mukhsudhi*, 1056.
 मुकसुधी *mukhsudhi*, 1056.
 मुगदर *mugdar*, 102.
 मुंगरा *mungra*, 106, 431, 457, 390,
 1262.
 मुंगरी *mungri*, 87, 106, 424, 555,
 390, 781.
 मुंगवा *mungwa*, 755.
 मुङ्ग *mung*, 994, 995.
 मुङ्गर *mungar*, 886n.
 मुङ्गा *munga*, 1073.
 मुजवानो *mujwāni*, 815.
 मुजवान *munjwān*, 815.
 मुजेरा *mujera*, 1461, 1477, 1481.
 मुटमुर *mutmur*, 1183.
 मुटनी *mutuni*, 973.
 मुठा *muttha*, 882, 1489.
 मुठी *mutthi*, 337.
 मुठरा *muthra*, 225, 1106.
 मुठरिया *muthariya*, 1106.
 मुठरी *muthri*, 1272.
 मुठवारा *muthwāra*, 335g.
 मुठल *muthāl*, 1106.
 मुठिया *muthiya*, 7, 89, 1106.
 मुठैल *muthail*, 1106.
 मुककटा *murkatāca*, 1485.
 मुकला *murla*, 956, 1107.
 मुकली *murli*, 956.
 मुकवार *murwār*, 269.

मुकुन्दारी *murwāri*, 256, 269.
 मुड़िया *muriya*, 414, 987.
 मुँड़िया *munriya*, 956.
 मुड़ियारी *muriyāri*, 1011.
 मुड़ियारी मारल *muriyāri māral*,
 1011.
 मुँड़िसन्वा *munrilca*, 956.
 मुँड़ेरा *munrera*, 1107.
 मुड़ेर *murer*, 939.
 मुँड़ेरा *munrera*, 939.
 मुँड़ेरी *mureri*, 939.
 मुडा *munda*, 725, 1107.
 मुडा *mundha*, 749.
 मुदती *mudati*, 1487.
 मुँदरी *mundri*, 60, 756, 769.
 मुदेखौनी *mudekhauni*, 1347.
 मुदेखी *mudekhi*, 1347.
 मुडी *muddhi*, 115.
 मुनगा *munga*, 1073, 1183.
 मुनधी *mundhi*, 115.
 मुनमुन *munmun*, 1183.
 मुनहर *munhar*, 77.
 मुन्दन *mundan*, 84, 554.
 मुन्दा *munda*, 860.
 मुन्दी *mundhi*, 767.
 मुरई *murai*, 1073.
 मुरुका *murka*, 1074, 1183.
 मुरुघटिया *murghatiya*, 1418.
 मुरुघट्टी *murghatti*, 1418.
 मुरुतहिन *murtahin*, 1481.
 मुरुती *murti*, 777.
 मुरुथारी *murthāri*, 638.
 मुरुदहट्टी *murdhatti*, 1418.
 मुरुदारी *murdāri*, 1139.
 मुरुधी *murdhi*, 975.
 मुरुरा *murra*, 585.
 मुरुरी *murri*, 1272.
 मुरुहा *murha*, 585.
 मुराद *marāi*, 1073, 1089.
 मुरिया *muriya*, 1074.

मुरिया *munriya*, 343.
 मुँरी *mānri*, 343.
 मुरेठा *muretha*, 724.
 मुरेना *morena*, 1183.
 मुरेरा *murera*, 269.
 मुल्लान *mullan*, 1087.
 मुली *mullā*, 1073.
 मुलावा *mushāta*, 1364, 1385.
 मुसद *musad*, 457.
 मुसरा *musra*, 416, 431, 464, 610.
 मुशर *mushar*, 1203, 1429, 1435.
 मुसकाए *musukāē*, 1088.
 मुष *muh*, 301.
 मुँष *muṣh*, 81, 301, 557, 454, 621,
 1247, 1428.
 मुँषखर *munhkhār*, 79.
 मुषचूर *muhchūr*, 963.
 मुँषड़ा *munhra*, 186.
 मुँषड़ा के नारी *munhra ke nāri*, 225.
 मुँषपण्डा *munhthapra*, 193.
 मुँषघोपण्डा *munhthopra*, 193.
 मुँष देख *munh dekhāb*, 1428.
 मुँषपसिया *muṣhpasija*, 1173.
 मुए *mūe*, 1084.
 मुंग *mūng*, 995.
 मुंगा *mūnga*, 755, 966c.
 मुँज *mūnj*, 815, 1422.
 मुठ *mūth*, 7, 29, 88, 89, 398, 1200,
 1434, 1437.
 मुँठ *mūnth*, 1433.
 मुठ पूजा *mūth puja*, 1434.
 मुठ लागल *mūth lāgal*, 1437.
 मुठा *mūtha*, 29, 543, 597, 882.
 मुठी *mūthi*, 88.
 मुड़ *mūr*, 269.
 मुँड़ *mūnr*, 274.
 मुड़ा *mūra*, 414, 1107.
 मुँड़ा *mūnra*, 274, 1107.
 मुँड़ी *mūri*, 343, 414.
 मुँड़ी *mūnri*, 251, 274.

मूर *mūr*, 1010.
 मूरदा *mūrha*, 585, 939.
 मूही *mūrhi*, 414, 726, 1272.
 मूत *mūt*, 848.
 मूंदन *mūndan*, 81.
 मूर *mūr*, 1073, 1475.
 मूरत *mūrat*, 777.
 मूरी *mūri*, 1119.
 मूरो *mūro*, 1073.
 मूल *mūl*, 1082, 1475.
 मूली *mūli*, 1073.
 मूसर *mūsar*, 431, 464, 610, 617.
 मेकराज *mekrāj*, 474, 588.
 मेसाना *mešana*, 247.
 मेसाना *mešana*, 247.
 मेसार *meār*, 689.
 मेसारी *mekhāri*, 388.
 मेघरा *meghra*, 161.
 मेहतर *mehtahar*, 1247.
 मेथिया *metiya*, 136, 713.
 मेरुटा *merura*, 936.
 मेरुरा *merura*, 585a.
 मेरुराय *meurrāy*, 1089.
 मेरुराया *merurarua*, 414.
 मेरुराया भाँची *merurarua bhānchi*,
 414.
 मेरुवा *mendhwa*, 1104.
 मेरुनी *medni*, 1037, 1129.
 मेसना *memna*, 1122, 1123.
 मेसनी *memni*, 1122.
 मेरखुन *merkhun*, 1272.
 मेहोआनी *mehoāni*, 801, 952.
 मेहान *melān*, 918.
 मेहानी *melāni*, 801.
 मेहनी *melhni*, 230.
 मेहटा *mehta*, 889.
 मेहटा *menhta*, 889.
 मेहतर *mehtar*, 1452.
 मेहराव *mebrāru*, 1275.
 मेहराव *meharāv*, 188.

मेहरी *mehri*, 1276.
 मेहिबाटी *mehibāti*, 677.
 मेहियाँ *mehiyān*, 889.
 मेहियाँ बैल *mehiyān bail*, 889.
 मेहीटी *meḥauti*, 889.
 मे *meñ*, 69, 655, 741, 478, 904,
 990, 1020, 1084, 1088, 1098,
 1263, 1275, 1350.
 मेख *mekh*, 1449.
 मेघ *megh*, 1092.
 मेघा *megha*, 1087, 1088.
 मेघु दाक *meghu dāk*, 1456.
 मेच *mench*, 633.
 मेज *mej*, 324.
 मेडा *meta*, 713.
 मेटी *meti*, 713.
 मेटुन *metum*, 414.
 मेद *menr*, 832, 953.
 मेदन *merhan*, 33.
 मेदा *menrha*, 889.
 मेथी *methi*, 1073.
 मेथी *menthi*, 1073.
 मेदनि *medani*, 1037.
 मेरु *meru*, 1033.
 मेल *mel*, 1042.
 मेह *meñh*, 889.
 मेहा *meha*, 889.
 मेहा *meñha*, 889.
 मेगिरी *maigiri*, 403.
 मेजनी *mañjni*, 887.
 मेखण्णा *mailchhanna*, 307.
 मेका *maika*, 1297.
 मेगर *maigar*, 161.
 मेदा *maida*, 1272.
 मेन *main*, 689, 1103, 1346.
 मेना *maina*, 1103, 1113.
 मेया *maiya*, 1456.
 मेरन *mairan*, 33.
 मेय *mail*, 1015, 1492.
 मेया *maila*, 848, 1015.

- मोचर *modr*, 1077.
 मोकदम *mokadam*, 1217.
 मोकररी *mokarari*, 1212.
 मोकरी *mokri*, 1209c.
 मोकन्हा *mokhra*, 924.
 मोकन्ही *mokhri*, 414.
 मोकन्हार *mokhtār*, 1183, 1208.
 मोकन्तिहार *mokhtiyār*, 1208.
 मोचडी *mochatti*, 1075.
 मोचन्ना *mochna*, 383, 474.
 मोचन्ना *mojamma*, 113.
 मोचरी *mojri*, 119.
 मोटन्डरवा *motāharwa*, 943.
 मोटरी *motri*, 318.
 मोटवाहा *motwāha*, 944.
 मोट्वाही *motwāhi*, 801.
 मोटन्हा *motha*, 938, 941, 1097.
 मोटन्हा जोड़ी *motha jori*, 941.
 मोटन्हा बरध *motha baradh*, 1097.
 मोटिया *motiya*, 730.
 मोट्हे किनाड़ी *mothre kināri*, 225.
 मोंदिवा *monrhiya*, 631.
 मोतरन्हा *motarpha*, 1201; Appendix, 14.
 मोतन्मन्ना *motmanna*, 1394.
 मोतल्के *motalke*, 1233.
 मोतन्धरन्हा *motharpha*, 1201.
 मोतिया *motiya*, 533.
 मोथपन्हा *mothapra*, 225.
 मोथापन्हा *mothāpra*, 193.
 मोनाफा *monāpha*, 1475.
 मोफरीद *mophrīd*, 1468 a & b, 1470, 1471; Appendix, 3, 9.
 मोरन्का *morka*, 1234.
 मोरन्नी *morni*, 238, 325.
 मोरन्वार *morwār*, 269.
 मोरन्वाह *morwāh*, 269, 283, 295, 945.
 मोंरन्वाह *monrwāh*, 283, 295.
 मोरन्सा *morassa*, 475.
 मोरन्ह *morhan*, 1022, 1024, 1039, 1194.
 मोरानी *morāni*, 954.
 मोरिया *morīya*, 233.
 मोहन्हाकी *molhaki*, 1468c, 1472; Appendix, 13.
 मोहन्हा *mohkhā*, 81, 301, 414.
 मोहन्हा *mohra*, 562.
 मोहन्वन्हा *mohanthambha*, 274.
 मोहन्देशार *mohdekhāi*, 1347.
 मोहन्दी *mohandi*, 159.
 मोहन्री *mohanri*, 159, 160.
 मोहब्बत *mohabbat*, 1252.
 मोहरन्हन *moharkan*, 540.
 मोहरम *moharam*, 1449.
 मोहरम के सिपाही *moharam ke sipāhi*, 1449.
 मोहरा *mohra*, 186.
 मोहरिदर *mohridār*, 727.
 मोहरी *mohri*, 1125.
 मोहन्ही *mohli*, 538.
 मोहन्ही खोहार *mohli lohār*, 538.
 मोहान *mohān*, 865.
 मोहरी *mohri*, 94.
 मोहैन *mohain*, 256.
 मोका *moka*, 922.
 मोंका *monka*, 1249.
 मोख *mokh*, 1250.
 मोखा *mokha*, 1250.
 मोच *moch*, 984.
 मोचा *mocha*, 984.
 मोची *mochi*, 479.
 मोंची *monchi*, 479.
 मोंछ *monchh*, 984.
 मोछा *mochha*, 984.
 मोजर *mojar*, 119.
 मोट *mot*, 14, 720, 936, 941, 1145.
 मोंट *mont*, 936.
 मोट चलाएव *mot chaldēv*, 941.
 मोटि *moti*, 720, 936.

मोटेहें *motailen*, 1002 (footnote).
 मोदा *morha*, 186.
 मोदा *monrha*, 631.
 मोही *morhi*, 990.
 मोती *moti*, 753, 765.
 मोती चूर *moti chūr*, 1272.
 मोती माळा *moti māla*, 765.
 मोती राम *moti rām*, 1456.
 मोथा *moth*, 997.
 मोथा *motha*, 1188.
 मोथा *montha*, 1075.
 मोथी *mothi*, 997.
 मोदक *modak*, 1272.
 मोना *mona*, 656.
 मोमिन *momin*, 355.
 मोर *mor*, 585f, 664 (footnote).
 मोर चक्कर *mor chakkar*, 585f.
 मोर बाज *mor bāj*, 585f.
 मोरी *mori*, 323, 823, 862, 963, 982,
 1435.

मोरी पेंगरी *mori petāri*, 963.
 मोल *mol*, 1113, 1419.
 मोहन *mohan*, 256, 755.
 मोहन माळा *mohan māla*, 755.
 मोहर *mohar*, 755, 918, 1284.
 मोहर देन *mohar den*, 1284.
 मोहर माळा *mohar māla*, 755.
 मौनिवा *mauniya*, 44, 442.
 मौरूसी *maurāsi*, 1215.
 मौवार *mauār*, 1154.
 मौगी *maugi*, 1275.
 मौजा *mauja*, 1499.
 मौन *maun*, 713.
 मौना *mauna*, 1075.
 मौनी *mauni*, 442.
 मौनी *maunni*, 44, 656.
 मौर *maur*, 1119, 1321, 1326.
 मौरी *mauri*, 1326.

॥ य y ॥

यों *yon*, 356.

॥ र r ॥

रर *rai*, 1037, 1272.
 रकसा *raksa*, 985, 991.
 रकसी *raksi*, 985.
 रकेबी *rakebi*, 713.
 रकनी *rakhni*, 1280.
 रकनब *rakhabak*, 1087.
 रकवार *rakhwār*, 870.
 रकवारी *rakhwāri*, 870.
 रकवाही *rakhwāhi*, 870.
 रकात *rakhāt*, 1147.
 रकांत *rakhānt*, 877, 1147.
 रकेलिन *rakhelin*, 1280.
 रकेही *rakhehi*, 1280.

रकौर *rakhaur*, 786.
 रग *rag*, 1486.
 रंगरेज *rangrej*, 504.
 रंगरेजी *rangreji*, 504, 509.
 रंगसाज *rangsāj*, 504, 509.
 रंगेहरी *rangehri*, 535.
 रघुनी डाक *raghuni dāk*, 1456.
 रघु *raghu*, 1456.
 राजपूत *rajpūt*, 964.
 राजार *rajāi*, 731.
 राजील *rajil*, 1217.
 राची *ranchi*, 1045.
 रातनी *ratni*, 1183.

रङ्गा *ratwa*, 967h.
 रङ्गार *rafrār*, 1426.
 रङ्गारी *rafrāri*, 1426.
 रहिषा *rarhiya*, 808, 1016, 1019.
 रधा *randa*, 1278.
 रधी *randi*, 1280.
 रज्ज्या *ratjagga*, 1372.
 रज्जु *ratral*, 1011.
 रता *ratāēl*, 1011.
 रतार *ratār*, 1058.
 रताळू *ratālu*, 1058.
 रती *ratti*, 1498, 1499.
 रथ *rath*, 148, 206.
 रदा *radda*, 1251.
 रङ्गिल्ली *rankilli*, 164, 929.
 रङ्गी *ranki*, 611.
 रथ *ranth*, 148, 206.
 रथी *ranthi*, 1416.
 रन्दा *randa*, 399, 401, 602.
 रङ्गनी *raphani*, 1488.
 रङ्गीदा *raphida*, 451.
 रबी *rabi*, 858.
 रबिळ *rabbil*, 426.
 रङ्गरङ्गा *ramkarwa*, 713.
 रङ्गुळा *ramchukka*, 713.
 रङ्गुळा *ramjūa*, 973.
 रमिषा *ramaniya*, 978.
 रमरमी *ramrammi*, 1339.
 रमुनी *ramuni*, 972.
 रम्पा *rampa*, 481.
 रम्बा *ramba*, 399.
 ररेठा *rāretha*, 896, 994.
 रवाई *rawāñ*, 1275.
 रवाईवाळा *rawāiswāla*, 580.
 रस *ras*, 366, 568, 1014, 1015, 1272.
 रस गोळा *ras gola*, 1272.
 रसगारा *rasghāra*, 270.
 रसगाडर *rasjāūr*, 1440.
 रसहन्ना *raschhanna*, 284.
 रसपाळ *raspāl*, 585.

रसपैव *raspāin*, 269.
 रसभङ्गा *rasbānta*, 595.
 रसरी *rasri*, 115, 145, 1492.
 रसवळ *rasvat*, 234.
 रसाण *rasāēl*, 1011.
 रसिदावा *rasidāna*, 1198.
 रसिदावन *rasidāwan*, 1198.
 रसिषा *rasiya*, 1272.
 रसिषाव *rasiyāo*, 1272.
 रसीद *rasid*, 1467, 1488.
 रसुवडू *rasuar*, 1203.
 रसून *rasūn*, 1073.
 रसुली *rasūli*, 1203.
 रसीडू *raser*, 270.
 रसोया *rasoiya*, 1248.
 रसोया घर *rasoiya ghar*, 1248.
 रसो *rasoi*, 1268.
 रसोळी *rasoli*, 140.
 रसा *rassa*, 115, 184, 375, 1272.
 रसी *rassi*, 115, 196, 123, 464, 613, 1492.
 रसुन *rassun*, 1073.
 राह *rahat*, 947.
 राहवार *rahatwār*, 533.
 राह्या *rahya*, 339.
 राह्या *rahna*, 478.
 राहर *rahar*, 994, 995, 1073.
 राहिया *rahariya*, 1073.
 राहिया सेम *rahariya sem*, 1073.
 राहरी *rahri*, 994.
 राहरेठा *rahretha*, 994.
 राहरेठा *rahraitha*, 994.
 राहल *rahal*, 987, 1043, 1234.
 राहाठ *rahāth*, 994.
 राहिला *rahila*, 1002.
 राही *rahi*, 144.
 राहे *rahe*, 1085, 1088.
 राहेठा *rahetha*, 896, 994.
 राई *rāi*, 1045, 1089, 1402.
 राईस *rāis*, 137, 140, 713.

राउत *rāut*, 1456.
 राउ *rāu*, 1084.
 राउस *rākas*, 1458.
 राँकी *rānki*, 371.
 राख *rākh*, 849.
 राख *rākhāb*, 1339.
 राखिबे *rākhiye*, 655.
 राँगा *rānga*, 511.
 राँगी *rāngi*, 969.
 राज *rāj*, 420, 1207.
 राज मजूर *rāj majūr*, 420.
 राज मिस्तिरी *rāj mistiri*, 420.
 राजा *rāja*, 1085, 1092, 1450.
 राटन *rātan*, 640, 1183.
 राड़ *rār*, 1217.
 राँड़ *rānr*, 1088, 1279.
 राड़ जाति *rār jāti*, 1217.
 राड़ भोर *rār bhor*, 1217.
 राँड़ा *rāñra*, 1278.
 राड़ी *rāri*, 1075, 1183.
 राड़ी *rārhi*, 1183.
 रात *rāt*, 965, 966, 1087, 1091.
 रातल *rātal*, 640.
 रातुक *rātuk*, 1088, 1091.
 रातुल *rātul*, 640.
 रादा *rāda*, 1251.
 राधे चक्कर *rādhe chakkar*, 585.
 रान *rān*, 289, 1272.
 रानी *rāni*, 1084.
 रान्ह *rānh*, 289.
 रापी *rāpi*, 481.
 राँपी *rānpi*, 481.
 राफ *rāph*, 1485.
 राफ साफ *rāph sāph*, 1485.
 राब *rāb*, 311, 1014, 1272.
 राम *rām*, 965c, 978, 1062, 1073.
 राम करहन्नी *rām karhanni*, 966d.
 राम केशौर *ram kesaur*, 1062.
 राम गोसाँई *rām gosāñin*, 1456.
 राम ठाकुर *rām thākur*, 1456.

राम नरोर *rāmtaroi*, 1073.
 राम दुलारी *rām dulāri*, 965c, 966e.
 राम दुलार *rām dular*, 978.
 राम परोर *rām paror*, 1073.
 राम बीर *rām bir*, 1456.
 राम राहर *rām rahar*, 1073.
 राम राम *rām rām*, 1339, 1419.
 राय *rāy*, 655.
 रायी *rāri*, 815.
 राह *rāl*, 737.
 रावा *rāwa*, 1014.
 रास *rās*, 82, 137, 226, 893, 1015, 1094, 1343, 1394.
 रास कड़ी *rās kari*, 226.
 रास के रास *rās ke rās*, 1015.
 रास पर लेब *rās par leb*, 1394.
 रास बरन बैस जेख *rās barag bais gel*, 1343.
 रासा *rāsa*, 1272.
 रासि *rāsi*, 137.
 राह *rah*, 456.
 राहट *rāhat*, 920.
 राहठ *rāhath*, 994.
 राहर *rāhar*, 994.
 राहरि *rāhari*, 994.
 राहिन *rāhin*, 1481.
 राह *rahu*, 1456.
 रिकाबी *rikābi*, 449, 711, 713.
 रिकेबी *rikebi*, 713.
 रिकौंच *rikaunch*, 1272.
 रिनिका *riniha*, 1461.
 रिरिबाव *ririyāy*, 1089.
 रिहम *riham*, 1372.
 रीत *rit*, 1381.
 रीत के जोड़ा *rit ke jora*, 1381.
 रुआरा *ruāra*, 1075.
 रुआरी *ruāri*, 1075.
 रुआह *ruāh*, 1422.
 रुआह काहब *ruāh kārhāb*, 1422.
 रुकन *rukñ*, 1465.

- रुकन *rukan*, 1465.
 रुका *rukka*, 1367.
 रुकसती *rukhsati*, 1389.
 रुकान *rukhan*, 394, 399.
 रुकानी *rukhani*, 399.
 रुद्राक्ष *rudrākh*, 755, 781.
 रुनी *runni*, 799, 800.
 रुपायी *rupaiyas*, 1133.
 रुपै *rupai*, 1479.
 रुपैया *rupaiya*, 1475, 1478, 1479, 1485.
 रुपै सेकड़ा *rupai saikra*, 1479.
 रुपौठी *rupauti*, 768.
 रुली *rulli*, 799.
 रु *rū*, 33.
 रूना *rūna*, 1017.
 रूई *rūi*, 333, 511.
 रूना *rūna*, 801.
 रूपधर *rūpdhar*, 1133.
 रूपधर *rūpdhaur*, 1133.
 रूपधौर *rūpadhaur*, 1113.
 रेखाप्रत *redet*, 1217.
 रेकाना *rekāna*, 1465.
 रेकानी *rekāni*, 713.
 रेगनी *regni*, 649.
 रेगनी *rengni*, 1075.
 रेनुवारी *renrudari*, 1045.
 रेवती *revti*, 267.
 रेवड़ा *rehura*, 1005.
 रेवती *reoti*, 1082.
 रेवड़ा *rehra*, 816.
 रेहन *rehan*, 1481.
 रेहार *rehār*, 816.
 रेहाक्ष *rehāh*, 816.
 रे *re*, 740, 1086.
 रेह *reh*, 957, 1045.
 रेह गैल *reh gail*, 957.
 रेहल *renral*, 957.
 रेहल बा *renral ba*, 957.
 रेहल *renra*, 956, 957, 987.
 रेहल भैल बा *renra bhail ba*, 957.
 रेहल भैल है *renra bhel hai*, 987.
 रेहल *renri*, 1045.
 रेह *ret*, 388.
 रेहली *reli*, 403, 418, 470, 471, 552, 560, 583, 591.
 रेवती *revti*, 260.
 रेह *reh*, 816, 1006.
 रेहनी *rainchi*, 1045.
 रेह *rain*, 269.
 रेहनी *rainsi*, 1087, 1091.
 रेहल *raiyat*, 1215.
 रेहनी *raiyati*, 1040.
 रेहल *raiyān*, 1217, 1226.
 रेहल *raihar*, 994.
 रोकरिया *rokariya*, 1484.
 रोकसत *roksat*, 1339.
 रोकसत कर *roksat karab*, 1339.
 रोकसति *roksati*, 1339.
 रोकसती *roksati*, 1291, 1294.
 रोकसदी *roksaddi*, 1291.
 रोजनामचा *rojnāmcha*, 1463a and b, 1464.
 रोजनामचा बही *rojnāmcha bahi*, 1463c.
 रोजबन्धी *rojbandhi*, 1185.
 रोजहा *rojha*, 1184.
 रोजीना *rojina*, 1185.
 रोपनिहार *ropnihār*, 864.
 रोपबा *ropba*, 1088, 1091.
 रोपवा *roppha*, 964.
 रोहवा *rorha*, 786.
 रोहवाक्ष *roriyāh*, 786.
 रोसकति करि देव *roskati kari deb*, 1339.
 रोसकती *roskati*, 1291.
 रोहनी *rohni*, 1082.
 रोहिनी *rohini*, 1082, 1084.
 रोक *rok*, 1488.
 रोकड़ *rokar*, 1463b.
 रोकड़ बही *rokar bahi*, 1463b.

रोकड़ बाकी *rokar baki*, 1463b.
 रोकड़ *rokar*, 871.
 रोग *rog*, 1173.
 रोगन *rogan*, 509.
 रोज *roj*, 1185.
 रोटी *roti*, 994, 1029, 1272.
 रोटीवाला *rotiwāla*, 445.
 रोड़ा *rora*, 269.
 रोड़ा *roda*, 335d.
 रोप *rop*, 964, 1008.
 रोपन *ropan*, 864.

रोपड़ *ropahu*, 1088.
 रोपा *ropa*, 964.
 रोपे *rope*, 1088.
 रोर *rora*, 269, 1037, 1266.
 रोह *roh*, 35, 424, 1207.
 रौंजी *raunji*, 815.
 रौड़ी *rauri*, 1499.
 रौंदा *raunda*, 1005.
 रौन *raun*, 269.
 रौना *rauna*, 115, 376.
 रौल *raul*, 424.

॥ ख १ ॥

खर *lai*, 480.
 खरन *lain*, 1266.
 खकंडो *laktho*, 1272.
 खकड़ी *lakri*, 35.
 खखनवाला खखाफ *lakhnavāla san-jāph*, 748.
 खखनौवाख खखाफ *lakhnavāl sanjāph*, 748.
 खखरौंख *lakhraṁo*, 814.
 खखौरी *lakhauri*, 1263.
 खंगड़ा *langra*, 301, 758, 1456.
 खगन *lagan*, 711, 1289, 1344.
 खगन पत्नी *lagan patri*, 1344.
 खगना *lagnā*, 7.
 खगन्याचे *lagpānche*, 1445.
 खंगरा *langra*, 274.
 खगवान *lagwān*, 1157.
 खगहर *laghar*, 1157.
 खगार *lagāi*, 1319, 1336.
 खगाप्रब *lagāeb*, 857, 1098, 1157, 1337, 1351, 1435.
 खगा के *lagā ke*, 69.
 खगान *lagān*, 1220.
 खगानी *lagāni*, 1479.
 खगाम *lagām*, 226.
 खगामी *lagāmi*, 96.
 खगार *lagār*, 26.

खगवान *lagāwan*, 1119.
 खगानरी *lagāwri*, 30.
 खगवख *lagāwas*, 1084.
 खगवे *lagāwe*, 1084.
 खगि *lagi*, 1087.
 खगुषा *lagua*, 842, 844.
 खगुषा जन *lagua jan*, 842.
 खगुसी *lagūsi*, 41.
 खंगोटा *langota*, 726.
 खंगोटी *langoti*, 726.
 खगौरी *lagauri*, 71, 128.
 खगा *lagga*, 40, 237, 1491.
 खगित *laggit*, 1468a and b, 1470, 1471 ; Appendix, 4, 10.
 खगुरी *laghuri*, 41, 237, 1491, 1492, 1496.
 खगौ *laggi*, 768.
 खङ्गड़ *langar*, 748.
 खङ्गर *langar*, 239.
 खङ्गोट *langot*, 726.
 खखनी *lachni*, 363.
 खखनिमिया *lakhminiya*, 1074.
 खखरी *lajuri*, 652.
 खट *lat*, 1400.
 खटक *latak*, 473.
 खटखोखार *latdhoāi*, 1400.
 खटल *latal*, 1094.

- लठम्बा *latwa*, 353, 501.
 लठौर *latāin*, 498.
 लठा *latta*, 1272.
 लठू *lattu*, 538.
 लठा *lattha*, 928, 1491.
 लठ *lath*, 653.
 लठङ्गर *lathangar*, 1323.
 लठम्बाची *lathwādi*, 915.
 लठापन्ची *lathābandi*, 1028.
 लठींगर *lathaungar*, 1323.
 लड्डू *laddu*, 1272, 1358.
 लङ्गुरिया *larhiya*, 147, 201.
 लड्डूचा *larua*, 1272.
 लधा *landha*, 1109.
 लव *lat*, 1183.
 लतकोरा *lathkora*, 225, 341, 1250.
 लतमरम्बा *latmarwa*, 1250.
 लतमरा *latmara*, 614, 939, 950, 1250.
 लतग्री *latri*, 735, 999.
 लतम्बा *latha*, 1098.
 लतार *latār*, 1058.
 लतिचौलें *latiyauleñ*, 1217.
 लतिधानी *latihāni*, 807.
 लते दा *latera*, 225.
 लता *latta*, 723.
 लती *lati*, 353.
 लथराव *lathrah*, 1117.
 लथेर *lather*, 896, 983, 1145.
 लदम्बा *ladna*, 882.
 लदम्बा *ladha*, 17.
 लदाव *ladāv*, 224.
 लदाुरी *ladauri*, 128.
 लदी *laddi*, 916, 954.
 लधी *ladhi*, 17.
 लपम्बा *lapta*, 1183.
 लपन्ची *lapei*, 1272.
 लपेटन *lapetan*, 363.
 लप्पा *lappa*, 184, 119.
 लप्पू *lappu*, 184, 191.
 लप्पो *lappo*, 622.
 लव गड्डूची *lab gachhuti*, 814.
 लवन्दा *labda*, 654.
 लवम्बा *labna*, 713.
 लवन्नी *labni*, 376, 713.
 लवव *labay*, 1084.
 लवेर *laber*, 419.
 लवेरी *laberi*, 419.
 लवम्बा *lamka*, 1059.
 लवम्बा चड्डूचा *lamka akua*, 1059.
 लवन्नी *lamti*, 828.
 लमरन्दार *lamardār*, 1208.
 लमेरा *lamera*, 861, 980.
 लम्बरन्दार *lambardār*, 1208.
 लम्बव *lambhab*, 1132.
 लम्बेर *lamher*, 861.
 लर *lar*, 595.
 लरन्डिया *larkatiya*, 985.
 लरन्का *larka*, 1074.
 लरन्किनी *larkini*, 1282.
 लरन्चा *larchha*, 1048.
 लरन्चोंका *larjonka*, 1183.
 लरत *larat*, 585.
 लरत देव *larat deb*, 585.
 लरम्बा *larna*, 56, 346, 439, 508, 571.
 लरन्नी *larni*, 17, 817.
 लरम *laram*, 786.
 लरम्बा *larma*, 1016.
 लरन्डो *larlo*, 270.
 लरम्बाचा *larwāha*, 915.
 लरम्बा *larha*, 40.
 लरन्ची *larhi*, 996, 1183, 1257.
 लरन्डो *larho*, 996.
 लरिका *larika*, 1281, 1286, 1401.
 लरिका खोज *larika khoj*, 1286.
 लरिका लोकाग्रव *larika lokāeb*, 1401.
 लरिची *lariki*, 1282.
 लरी *lari*, 363.
 लरुचा *larua*, 195, 990.
 लरीठा *larētha*, 896.

लरेठो *laretho*, 994.
 लकवा *lalka*, 956, 1057, 1059.
 लकवी *lalki*, 786.
 लकवी मिट्टी *lalki mitti*, 786.
 ललगोंदिया *lalgondiya*, 968.
 ललगोंड़ी *lalgonri*, 1005.
 ललदेरवा *laldeiya*, 967, 972.
 ललरी *lalri*, 765.
 ललहात वा *lalhāt ba*, 987.
 ललठा *lawtha*, 2, 825.
 ललठा के जोत *lawtha ke jot*, 825.
 ललस *lasam*, 480.
 ललग्ना *lanhgu*, 743.
 ललठी *lahthi*, 571.
 ललना *lahna*, 1477.
 ललनाप्रल *lahnāēl*, 1079.
 ललबेटा *lahbeta*, 1279.
 ललहर *lahar*, 1173.
 ललहरी *laharni*, 383, 1030.
 ललरैठा *lahraiṭha*, 994.
 लललहा *lahlaha*, 987.
 लललहा रहल है *lahlaha rahal hai*,
 987.
 ललवाड़ *lahwāi*, 303.
 ललसुन *lahsun*, 1073.
 ललसुर *lahsur*, 574.
 ललहास *lahās*, 115.
 ललहासी *lahāsi*, 115, 239.
 ललहरी *lahuri*, 1276.
 ललहेरिया *laheriya*, 533.
 ललहेरा *lahera*, 570.
 ललहेरी *laheri*, 570.
 ललहौंगा *lahaunga*, 480.
 ललहौरी *lahauri*, 1263.
 ला *la*, 444, 572, 1272, 1419.
 लाइ *lai*, 1272.
 लाइठ *lāith*, 346.
 लाइलि *lāili*, 740.
 लाउर *laur*, 653.
 लाइड *laed*, 92.

लाइब *laeb*, 25, 1478.
 लाइ *lakh*, 570.
 लाइराज *lākhraj*, 1209b.
 लाग *lag*, 1445.
 लागत वा *lagat ba*, 1001.
 लागन *lagan*, 7.
 लागनि *lagani*, 331.
 लाग पचमी *lag panchami*, 1445.
 लागल *lagal*, 1001, 1004, 1437.
 लाँगल *lāngal*, 1.
 लागी *lāga*, 1383.
 लागी *lāgi*, 1482.
 लागे *lāge*, 1026.
 लाँजी *lānji*, 965k.
 लागौ *lāgau*, 45.
 लाट *lat*, 1207.
 लाटा *lāta*, 1272.
 लाठ *lāth*, 273, 346, 414, 431, 917,
 928, 931.
 लाठा *lātha*, 116, 414, 928, 931.
 लाठी *lāthi*, 362, 390, 653, 655,
 833, 1085.
 लाठीन्दोर *lathidor*, 362.
 लाइनि *lārani*, 439.
 लाँहा *lānrha*, 1109.
 लाइ *lād*, 92, 713.
 लाइ *lādh*, 258, 276.
 लाधा *lādha*, 17.
 लाबर *lābar*, 419.
 लाभ *lābh*, 900, 1483.
 लाँभव *lāmbhab*, 1132.
 लाभ लाभ *lābh sābh*, 1483.
 लाभ *lām*, 861.
 लाँभव *lāmbhab*, 1132.
 लार *lār*, 75, 60, 90, 880, 894, 963,
 990, 1183, 1259.
 लारन *lāran*, 17.
 लारनि *lārani*, 346.
 लारी *lāri*, 529, 570.
 लारु *lāru*, 60.

- लाल *lal*, 585, 975, 1135, 1138,
 1306, 1499.
 लाल केशर *lal kesar*, 975.
 लाल देरवा *laldeiya*, 972.
 लाल बगच्छा *lal bagchhalka*, 1138.
 लाल माटी *lal māti*, 1806.
 लालमी *lālmi*, 1065.
 लाला *lāla*, 585.
 लालन *lāwan*, 1477.
 लालन भावन *lāwan jhāwan*, 1477.
 लावा *lāwa*, 493, 1272, 1309, 1332,
 1445, 1483.
 लावा घोली *lāwa ghōli*, 1483.
 लावा चिटार *lāwa chhitāi*, 1309, 1332.
 लावा दूबा *lāwa dūa*, 1483.
 लावा मिरारब *lāwa mirāib*, 1332.
 लासा *lāsa*, 381.
 लाह *lāh*, 570, 713.
 लाहखर *lākhkar*, 482.
 लाहाउरी *lāhāuri*, 1263.
 लाही *lāhi*, 1045, 1074.
 लिबावन *liāwan*, 1292.
 लिख *likh*, 655.
 लिख गहनी *likh gahni*, 747.
 लिखन्नी *lijhri*, 1401.
 लिटी *litti*, 466, 994, 1272.
 लिटी *liddi*, 848.
 लिपार *lipāi*, 1402, 1413.
 लिपे *liye*, 655.
 लिहार *lihāi*, 408, 526.
 लिहार *lihāwar*, 397.
 लीद *lid*, 848.
 लीदी *lidi*, 848.
 लील *lil*, 1038, 1040.
 लीला *lila*, 1043.
 लीला डोम *lila dom*, 1456.
 लीलू *lihu*, 585(f).
 लुकनारी *lukwāri*, 1448.
 लुकान *lukān*, 957.
 लुकारी *lukāri*, 1448.
 लुकुम *lukum*, 1268.
 लुकर्री *lukhri*, 1091.
 लुगरिबे *lugriye*, 740.
 लुगरी *lugri*, 740.
 लुग्गा *lugga*, 723.
 लुङ्गी *lungi*, 383, 726, 733, 1430.
 लुण्डा *lunda*, 710.
 लुचुई *luchui*, 1272.
 लुतिवा *lutiya*, 1073.
 लुपन्धी *lupdhi*, 977.
 लुरका *turka*, 1074.
 लूकहिँ *lūkahiñ*, 1087.
 लूका *lūka*, 1419.
 लूगा *lūga*, 723, 740.
 लूंगी *lūngi*, 733, 1430.
 लूँडा *lunra*, 121, 710.
 लूँदर *lenrai*, 1075, 1183.
 लूँद्वारी *lenrwāri*, 1045.
 लूँद्वी *lenruri*, 984.
 लूँद्विवाण *lūrhiyaēl*, 1153.
 लूँतार *letāhar*, 1292.
 लूँदरा *ledra*, 731.
 लूँदरा *lendra*, 637, 731.
 लूँदाल *ledāl*, 1267.
 लूँवारी *leyāri*, 1292.
 लूँववा *lerua*, 990.
 लूँवनिहार *lewmihār*, 874.
 लूँवार *lewār*, 376.
 लूँवारा *lewāra*, 154.
 लूँवनिवाला *lenhriwāla*, 1156.
 लूँवना *lehna*, 1144.
 लूँवनी *lehni*, 512, 555, 557, 880.
 लूँवपुर *lehsur*, 574.
 लूँवार *lehāi*, 408.
 लूँवाण *lehāe*, 549.
 लूँवाण *lehāph*, 731.
 लूँवाडी *lehāk*, 731.
 लूँवोंगा *lehonga*, 480.
 ले *le*, 572, 919, 1025, 1084, 1416.
 लेर *lei*, 423, 480.

लेखा *lekha*, 1463c.
 लेखा बही *lekha bahi*, 1463c.
 ले जाग्रव *le jāēb*, 919.
 लेंद *lenr*, 1045.
 लेंरी *lenri*, 848.
 लेंद *lenrh*, 1153.
 लेंदा *lenrha*, 984, 1074.
 लेन *let*, 568.
 लेद *led*, 932.
 लेदा *leda*, 932.
 लेदी *ledi*, 932.
 लेध *ledh*, 932.
 लेधत *ledha*, 258.
 लेधा *ledha*, 17, 276.
 लेधो *ledho*, 932.
 लेन *len*, 1461
 लेन देन *len den*, 1461.
 लेने *lene*, 3.
 लेने चाव *lene āw*, 3.
 लेब *leb*, 915, 1394, 1419, 1429, 1435,
 1478, 1484, 1485.
 लेरु *leru*, 1118.
 लेलें *lelēn*, 1217.
 लेव *leo*, 709, 824, 915, 981.
 लेव करव *leo karab*, 981.
 लेवत *lewat*, 645.
 लेवन *lewan*, 709.
 लेवा *lewa*, 126, 233, 637, 709, 824,
 858, 915, 1032, 1259.
 लेवा खान्ही *lewa khānhi*, 1259.
 लेसो *leso*, 1054, 1055.
 लेंहर *leñhar*, 1124.
 लेहन *lehan*, 880.
 लेहला *lehala*, 904.
 ले *lai*, 604, 763, 1451.
 लेधा *laidha*, 17.
 लेन *lain*, 1160.
 लेनु *lainu*, 1161, 1166.
 लोकनाथा *loknātha*, 1293.
 लोकनिथा *lokaniya*, 1293.

लोकनी *lokani*, 1293.
 लोकाग्रव *lokaēb*, 1401.
 लोकाना *lokāna*, 1140, 1141.
 लोङ्गवूरा *longchāra*, 973.
 लोङ्गिया मरिचा *longiya maricha*, 1078.
 लोङ्गिया मिरिच *longiya mirich*, 1073.
 लोचनी *lochni*, 363.
 लोङ्गकी *lotki*, 690.
 लोटःली *lotli*, 1339.
 लोङ्गियारी *loriyaro*, 1154.
 लोङ्गाहर *lorhtāhar*, 878.
 लोङ्गनिहार *lorhnihar*, 878, 1017.
 लोङ्गिया *lorhiya*, 878.
 लोभेरुवा *lobherua*, 769.
 लोरकार *lorkāi*, 1154.
 लोरिका *lorika*, 1154.
 लोचङ्गा *lohanga*, 480.
 लोहङ्ग *lohanra*, 929.
 लोहरा *lohra*, 878, 967j.
 लोहरना *lohra*, 695.
 लोहररी *lohri*, 695.
 लोहलङ्गर *lohlangar*, 239.
 लोहसारी *lohsāri*, 407.
 लोहामा *lohāma*, 10.
 लहार *lohār*, 407, 538, 1194, 1204.
 लोहिया *lohiya*, 466, 480, 673, 695.
 लोहया *lōiya*, 1251, 1272.
 लोखर *lokhar*, 383, 482, 734.
 लोग *log* 1217, 1275.
 लोचर *lochar*, 1120.
 लोट *lot*, 1052.
 लोटा *lota*, 115, 687, 711.
 लोटी *loti*, 1052.
 लोडा *lora*, 1266.
 लोद *lorh*, 421.
 लोहन *lorhan*, 899.
 लोदा *lorha*, 627, 878, 914, 1317.
 लोदा बिचा *lorha bichcha*, 878.
 लोही *lorhi*, 627, 748, 878.

लौंदा *londa*, 466, 1251.
 लौंदी *londi*, 1251.
 लोथा *lotha*, 318.
 लोपन *lopan*, 551, 705.
 लोर *lor*, 753, 764.
 लोह *loh*, 414.
 लौंगरा *laungra*, 758.
 लौंगरी *laugāchhi*, 814.
 लोहूषा *lakhua*, 1326.

लौंगार *laungāhar*, 1292.
 लौषा *laua*, 1068.
 लौका *lauka*, 1068.
 लौकी *lauki*, 585.
 लौंग *laung*, 763.
 लौठा *lautha*, 377.
 लौनी *launi*, 873.
 लौनी करल *launi karal*, 873.
 लौर *laur*, 653.

॥ व w ॥

वजू *waju*, 1430.
 वजू करारण *waju karāēb*, 1430.
 वषा *wapha*, 1482.
 वादा *wāda*, 1367.
 वादा का रुक्का *wāda ka rukka*, 1367.

वारजा *wārja*, 1470, 1471.
 वाला *wāla*, 502, 832, 889, 1006,
 1267.
 वासिल *wāsil*, 1468a, 1472.
 वासिल बाकी *wāsil bāki*, 1468a, 1472.

॥ श sh ॥

शगुन *shagun*, 1454.
 शरार *sharai*, 1361, 1362.
 शलुका *shaluka*, 729.
 शादी *shādi*, 1273.
 शाम *shām*, 1183.
 शाम तुलसी *shām tulsi*, 1183.

शाहाना *shāhāna*, 1381.
 शिकमी *shikmi*, 1225, 1226.
 शतुर *shutur*, 1131.
 शमङ्गली *shumangali*, 1273, 1328.
 शोर *shoi*, 1369.
 शौहर *shauhar*, 1274.

॥ स s ॥

सं सॉ, 1113.
 सरल *sail*, 938.
 सकरई *sakrai*, 1474.
 सकरकण्ड *sakarkand*, 1059.
 सकरचीनी *sakarchini*, 1005.
 सकरपाळा *sakarpāla*, 1272.
 सकारन *sakarab*, 1487.
 सकार *sakkar*, 318, 1014, 1089.
 सखारी *sakhari*, 657.
 सगपहिना *sagpahita*, 1272.

सगरदिना *sagardina*, 837.
 सगना *sagra*, 1091.
 सँगना *sangra*, 922.
 सगहम *sagaham*, 1279.
 सगडुषा *sagahua*, 1279.
 सँगडुषा *sañghua*, 1279.
 सगार *sagāi*, 1279.
 सँगहा *sangāha*, 1201.
 सँगिया *sangiya*, 73.
 सगुन *sagun*, 1454.

सगुनी *saguni*, 177, 193.
 सगुन *sagun*, 177, 178, 179, 184,
 190, 191, 193, 195, 200, 204.
 सग्वर *saggar*, 147, 201, 203, 204.
 सङ्कर *sankar*, 771, 1014.
 सङ्कल्प *sankalp*, 1209a.
 सङ्ग *sankh*, 776.
 सङ्ग *sang*, 655, 990, 1184.
 सज्जना *sajwa*, 1163.
 सैक्यहरिया *sanjhariya*, 837.
 सजाव *sajao*, 1163.
 सजाव दही *sajao dahi*, 1163.
 सजिवन *sajivan*, 1068.
 सजुद *sajui*, 1162.
 सजेचा *sajea*, 636.
 सजोर *sajor*, 858.
 सज्जा *sajjha*, 846.
 सज्जिया *sajhiya*, 291.
 सैज्जिया *sanjhiya*, 837.
 सज्जियेती *sajhyaiti*, 291.
 सैज्जीचा *sanjhausa*, 1270.
 सञ्चा *sancha*, 576, 984.
 सञ्जाफ *sanjaph*, 748.
 सटक *satak*, 473.
 सटका *satkā*, 99, 653.
 सटिया *satiya*, 762.
 सटौचा *sataua*, 1482.
 सटौचा पटौचा *sataua pataua*, 1482.
 सठोरा *sathora*, 1399.
 सडुका *sarka*, 1074.
 सडुन्ही *sanrsi*, 404, 411, 511, 515,
 539, 546, 557, 560, 552, 704.
 सडुन्ही *sanrāri*, 330.
 सडुन्हा *sanrusa*, 32.
 सडे *sare*, 1087.
 सडुी *saddhi*, Appendix, 2a.
 सण्ठी *santhi*, 896, 1048.
 सत *sat*, 12, 1332.
 सतधरन्वा *satgharwa*, 442.
 सतधर *satattar*, 1118.

सतदन्ता *satdanta*, 1118.
 सतदर *satdar*, 1118.
 सत धरिया *sat dhariya*, 12.
 सतन्नाहप्रब *satnahāeb*, 1424.
 सतन्पुतिचा *satputiya*, 1069.
 सतन्भीचा *satbhikha*, 1082.
 सत भौरी *sat bhauri*, 1332.
 सतन्मसुचा *satmasua*, 1396.
 सतन्मास *satmās*, 1396.
 सतन्रङ्गी *satranji*, 750.
 सतरिया *satariya*, 965f.
 सतन्लरी *sātlari*, 765.
 सतन्वनिचाँ *satwaniyañ*, 238.
 सतन्वाँस *satwāns*, 1396
 सतन्वाँसा *satwānsa*, 1396.
 सतन्वाँसु *satwānsu*, 1396.
 सती *sati*, 1456.
 सतुचा *satua*, 1272.
 सतुन्चारन *satuañ*, 1449.
 सतुन्चानी *satuañi*, 1449.
 सतुर् *satui*, 1272.
 सत्तर *sattar*, 1118.
 सती *satti*, 572.
 सतू *sattu*, 1272, 1443, 1449.
 सधन्धर *sathdhar*, 1118.
 सदर *sadar*, 1249.
 सदर दरन्वाजा *sadar darwāja*, 1249.
 सदरी *sadari*, 729.
 सदा *sada*, 655.
 सदिघात *sadiyāt*, 1201.
 सदिघाना *sadiyāna*, 1201.
 सडुकची *sandukchi*, 656.
 सधन्वा *sadhwa*, 1277.
 सधोर *sadhor*, 1399.
 सधौचा *sadhaua*, 1210, 1482.
 सधौचा पटौचा *sadhaua pataua*, 1210,
 1482.
 सन *san*, 29, 165, 886n, 984, 1047,
 1089.
 सनर *sanar*, 1048.

सङ्कोची *sanki*, 713.
 सन्धोचा *sandhoa*, 542.
 सन्सनाठी *sansanāthi*, 1048.
 सन्सा *sansa*, 546, 557.
 सन्सी *sansi*, 552, 554.
 सन्सोगिला *sansogila*, 661.
 सन्सक *sanhak*, 713.
 सन्सकी *sanhaki*, 713.
 सना *sana*, 1272.
 सनाठी *sandthi*, 1048.
 सनिचरा *sanichra*, 1456.
 सनीचर *sanichar*, 1088.
 सनुक्की *sanukchi*, 656.
 सनुक *sanukh*, 656.
 सनुक *sanuk*, 656.
 सनेस *sanés*, 1347.
 सने *sanai*, 1048.
 सनेठा *sanattha*, 1048.
 सनौठा *sanauta*, 685.
 सन्डूख *sandukh*, 656.
 सन्दूक *sundūk*, 656.
 सन्देह *sandeh*, 1272.
 सन्यासी *sanyāsi*, 1203, 1429.
 सपरी *sapari*, 309.
 सपट *sapat*, 860.
 सपट कारख *sapat jāil*, 860.
 सपटा *sapta*, 860
 सपटा कारख *sapta jāil*, 860.
 सपनाद *sapnāi*, 1234.
 सपरी *sapri*, 662.
 सपुरा *spura*, 1050.
 सप्तमी *saptami*, 1087.
 सफ *saph*, 751.
 सफर *saphai*, 305.
 सफगोल *saphgol*, 1073.
 सफार *saphāi*, 1485.
 सफेद *saphed*, 976.
 सफैचा *saphaiya*, 305.
 सपन्जा *sabja*, 1036.
 सपञ्जी *sabji*, 996.

सभडेती *sabthasti*, 291.
 सभरा *sabra*, 513, 549.
 सभरी *sabri*, 513, 549.
 सभुजा *sabuja*, 1043.
 सभुजी *sabuji*, 1036.
 सभ *sabh*, 12, 1026, 1085, 1089.
 सभन्धर *sabhdhar*, 12.
 सभ धरिबा *sabh dhariya*, 12.
 सभदान *samdān*, 524, 549.
 सभध *samadh*, 1279.
 सभधिम *samdhin*, 1302.
 सभधी *samdhi*, 1302, 1339.
 सभधी मिलावा *samdhi milāwa*, 1339.
 सभधो *samdho*, 1339.
 सभन *saman*, 1210.
 सभन्सान *samsān*, 1418.
 सभन्सेबन्ड *samseband*, 768.
 सभन्सेर *samsēr*, 502.
 सभन्सेरक *samsērak*, 502.
 सभन्डत *samhut*, 839, 877, 1433,
 1439.
 सभा *sama*, 989.
 सभाचारी *samāchāri*, 1487.
 सभाचारी चिट्ठी *samāchāri chīthi*,
 1487.
 सभाठ *samāth*, 431, 464, 610, 617.
 सभाँठ *samānth*, 610.
 सभाध *samādh*, 1429.
 सभाध में बैसाध *samādh men baisādh*,
 1429.
 सभाधि *samādhi*, 1429.
 सभाधि (or सभाध) लेब *samādhi (or
 samadh) leb*, 1429.
 सभार *samār*, 819, 826, 828, 857.
 सभाही *samāhi*, 726.
 सभाह *samāh*, 826.
 सभियाँ *samiyān*, 618.
 समुक *samukh*, 1249.
 समुक दरोजा *samukh daroja*, 1249.
 सभेख *samel*, 18.

- समैया *samaiya*, 16.
 समैल *samail*, 15, 16, 194, 18, 938.
 समैला *samaila*, 16, 938.
 समोसा *samosa*, 1272.
 समौचा *samaua*, 610, 618.
 समौच *samaudh*, 818, 839.
 सम्बन्ध *sambandh*, 1279.
 सम्मान *samman*, 568.
 सम्मल *sammal*, 194.
 सर *sar*, 358, 949.
 सरई *sarai*, 1051.
 सरक *sarak*, 1174.
 सरक जाग्रव *sarak jāēb*, 1174.
 सरकण्डा *sarkanda*, 1051.
 सरकण्डी *sarkandi*, 565.
 सरका *sarka*, 358.
 सरकार *sarkār*, 1208.
 सरकाँनी *sarkauni*, 363.
 सरकाँनी के खूँटी *sarkauni ke khunti*,
 363.
 सरकहत *sarkhat*, 1464.
 सरग *sarag*, 105, 1101, 1113.
 सरगपताळी *saragpatāli*, 1101, 1113.
 सरगाँ *sargān*, 494.
 सरङ्गपताळी *sarangpatāli*, 1101.
 सरङ्गा *saranga*, 230.
 सरन्दर *sardar*, 1028, 1257.
 सरन्दर परन्तर *sardar partar*, 1028.
 सरन्दार *sardār*, 1450, 1452.
 सरपंच *sarpanch*, 1450.
 सरपत *sarpat*, 120.
 सरपोस *sarpos*, 700, 711.
 सरबत *sarbat*, 1015, 1272.
 सरबी *sarbi*, 713.
 सररा *sarra*, 940.
 सरवा *sarva*, 438.
 सरसी *sarsi*, 511.
 सरसों *sarson*, 1045.
 सरह *sarah*, 1220.
 सरहन्ची *sarhanchi*, 1183.
 सरहज *sarhaj*, 1386.
 सरहथ *sarhath* 55.
 सरहबन्दी *sarahbandi*, 1220.
 सरहिया *sarahiya*, 438.
 सराई *sarāi*, 551, 705, 775.
 सराफ *sarāph*, 1461.
 सरासर *sarāsar*, 475.
 सरिकदार *sarikdār*, 1214.
 सरिन्ना *sarinna*, 230.
 सरिया *sariya*, 740.
 सरिया के *sariyā ke*, 817.
 सरिया के जोतल *sariyā ke jotal*, 817.
 सरिया के धरल *sariya ke dharal*, 817.
 सरिसो *sariso*, 896, 1045.
 सरिसों *sarison*, 1045.
 सरिहन *sarihan*, 969, 972.
 सरि *sari*, 972.
 सरे *sare*, 1220.
 सरेस *sares*, 404.
 सरेस कन्ना *sares kannā*, 404.
 सरेस कागज *sares kāgaj*, 404.
 सरेस पत्ता *sares patta*, 404.
 सरेह *sareh*, 784b.
 सरेला *saraila*, 48.
 सरौंची *saraunchi*, 1183.
 सरौता *sarauta*, 1056.
 सखण्डो *salkho*, 1456.
 सखगम *salgam*, 1073.
 सखगा *salga*, 730.
 सखगम *saljam*, 1073.
 सखवात *sahvāt*, 1408.
 सलाई *salāi*, 221, 386, 499, 539,
 546.
 सलाग *salāg*, 566.
 सलाम *salām*, 1393.
 सलामी *salāmi*, 1201, 1205, 1347,
 1474.
 सलीना *salina*, 230, 1185.
 सलेस *sales*, 592, 1456.
 सलैया *salaiya*, 221.

- सल्लेस *salhes*, 1455, 1456.
 सल्लेस सल्लान, *salhes asthān*, 1455.
 सवार *sawāi*, 1092, 1475, 1479.
 सवार डेदी *sawāi derhi*, 1475.
 सवामी *sawāmi*, 1274.
 सवार *sawār*, 235.
 सवारी *sawāri*, 1275.
 सवासिन *sawāsīn*, 1277.
 सवेसा *sawaiya*, 1203, 1479, 1500.
 ससुरा *sasura*, 1296.
 ससुरार *sasurār*, 1296, 1300.
 ससुराल *sasurāl*, 1296.
 ससुरैतिन *sasuraitin*, 1277.
 संकार *sanskār*, 1416.
 संकार देव *sanskār deb*, 1416.
 सहज *sahjan*, 1073, 1183.
 सहजना *sahjana*, 1073.
 सहजादी मार *sahjādi māi*, 1456.
 सहजा मार *sahja māi*, 1456.
 सहतौर *sahṭir*, 322.
 सहदेरवा *sahdeīya*, 966e.
 सहन *sahan*, 235.
 सहनक *sahnak*, 1377.
 सहरी *sahri*, 887.
 सहरोस *sahras*, 1117.
 सहस *sahal*, 414.
 सहसर *sahasar*, 604.
 सहार *sahār*, 1203.
 सहिजन *sahijjan*, 1073.
 सही *sahi*, 990.
 सहेर *saher*, 1124.
 सही *sāhiñ*, 1183, 1274.
 सासत *sāut*, 1276.
 साप्रबान *sāēbān*, 1242, 1430.
 सासोंख *sāonkh*, 842.
 सासोन *sāon*, 1082, 1087, 1088.
 सांभोर *sāñor*, 1113.
 साक *sak*, 1486.
 साक उखरु गेलेनि *sak ukhar gelainhi*,
 1486.
 सांखा *sānkha*, 538.
 साग *sāg*, 1001, 1073.
 सांग *sānga*, 3, 1255.
 सागड़ *sāgar*, 147, 201.
 सागर *sāgar*, 782.
 सांगह *sāngah*, 3, 1255.
 सांघुत *sāñghut*, 1279.
 साचक *sāchak*, 1381.
 सांचा *sāncha*, 419, 557, 560, 565,
 570, 576, 600.
 सांची *sānchi*, 726, 1049, 1163.
 साज *sāj*, 1371.
 साजन *sājan*, 372.
 साज बेचोतब *sāj beotab*, 1371.
 साजी *sāji*, 45.
 सांज *sāñjh*, 226.
 सांज ले *sāñjh le*, 837.
 साटा *sātā*, 99.
 सांटा *sānta*, 99.
 साटी *sāti*, 477, 843, 1155.
 साटी पाटी *sāti pāti*, 843.
 साठ *sāth*, 965, 966.
 साठी *sāthi*, 965, 966f, 1085, 1089.
 साड़ी *sāri*, 740.
 सांर *sānrh*, 5, 1095, 1112.
 सादा *sāda*, 468, 585f, 1023, 1250.
 सादा चादर *sāda chādar*, 585f.
 सादियात *sādiyāt*, 1201.
 सादी *sādi*, 1273.
 साध *sādh*, 1484.
 साधव *sādhav*, 1484.
 साधा लेव *sādh leb*, 1484.
 साधनी *sādhni*, 426.
 साधू *sādhu*, 782.
 सान *sān*, 538, 539, 1025, 1086.
 सानि *sāni*, 1272.
 सानी *sāni*, 1144, 1145, 1279.
 सानी पानी *sāni pāni*, 1145.
 सानी पानी करव (or देव) *sāni pāni*
karav (or deb), 1145.

सापट *sāpat*, 847.
 साँपुर *sāmpur*, 1050.
 साफ *sāph*, 1485.
 साफी *sāphi*, 401, 404, 733, 1430.
 साफी रत्तां *sāphi randa*, 401.
 साबर *sābar*, 549, 1139.
 साबल *sābal*, 513.
 साबुन *sabun*, 393, 740.
 साभ *sābh*, 1483.
 साम *sām*, 60, 221, 618, 975.
 साम जीरा *sām jira*, 975, 979.
 सामा *sāma*, 221, 989, 1183.
 साँमा *sāmma*, 221.
 सामी *sāmi*, 60, 221, 249, 1088,
 1183, 1274.
 सायर *sāyar*, Appendix, 16.
 सायाबन्दी *sāyābandī*, 1373.
 साहीं *sārhi*, 1163.
 सार *sār*, 977, 978, 1087, 1153.
 सारंगी *sarangi*, 276.
 सारजी *sārji*, 748.
 सारा *sāra*, 611, 1419.
 सारि *sāri*, 1087.
 सारी *sāri*, 740, 766, 1385.
 सारू *sāru*, 1173.
 साल *sāl*, 379, 1118.
 सालक *sālak*, 414.
 सालग्राम *sālgrām*, 1451.
 सालियाना *sāliyāna*, 1185.
 सालिस *sālis*, 913.
 साली *sāli*, 1089, 1194.
 सालीना *sālina*, 1185, 1207.
 सालीना खर्च *sālina kharch*, 1207.
 सालू *sālu*, 742, 1042.
 साव *sāo*, 1461.
 साँवगी *sāmvgi*, 208, 212, 213, 224.
 साँवगी गाड़ी *sāmvgi gāri*, 148, 208.
 सावन *sāwan*, 1082.
 साँवर *sāmvar*, 1134.
 सावाँ *sāwāñ*, 989.

साँवाँ *sāwāñ*, 989, 1074, 1183.
 सालिग्राम *sāligrām*, 1451.
 साँस *sāns*, 1272.
 सासन *sāsat*, 495.
 साँसन *sānsat*, 495.
 साँसर *sānsar*, 495.
 साँसी *sānsi*, 301.
 सासुर *sāsūr*, 1296.
 साह *sāh*, 1250, 1461, 1474.
 साहबगंज *sāhabganj*, 1183.
 साहवाला *sāhwāla*, 1250.
 साहिल *sāhil*, 965m, 966f.
 साही *sāhi*, 1005.
 साडकार *sāhukār*, 1461.
 साडल *sāhul*, 425.
 साहेब *sāheb*, 1456.
 सिअंठा *siānthā*, 703.
 सिकन्हा *sikanja*, 587.
 सिकन्हा *sikra*, 793.
 सिकन्ही *sikri*, 1262.
 सिकन्हीर *sikraur*, 793.
 सिकन्दरी *sikandri*, 1491.
 सिकन्दरी गज *sikandri gaj*, 1491.
 सिकन्पटरी *sikpatai*, 657.
 सिकन्मी *sikmi*, 1212, 1213, 1214,
 1219, 1225.
 सिकन्रा *sikra*, 107.
 सिकन्री *sikri*, 107, 755, 762, 764,
 765, 767.
 सिकस *sikast*, 788.
 सिकन्हर *sikhar*, 648, 651, 1422.
 सिकहती *sikahuti*, 41.
 सिकार *sikār*, 1232.
 सिकार माही *sikār māhi*, 1232.
 सिकियो *sikio*, 1087.
 सिकिलगर *sikilgar*, 602.
 सिकौती *sikauti*, 44.
 सिकड़ *sikkar*, 107.
 सिकर *sikkar*, 107.
 सिक्का *sikka*, 651, 235.

- सिङ्गचा *sinkhcha*, 711.
 सिङ्गजुहा *singjutta*, 1102.
 सिङ्गजूटल *singjūtal*, 1102.
 सिङ्गठा *singtha*, 480.
 सिङ्गता *sigta*, 786.
 सिङ्गरा *singra*, 965n.
 सिङ्गचा *singha*, 954.
 सिङ्गासन *singāsan*, 777.
 सिङ्गेसर *singesar*, 1456.
 सिङ्गट्टा *singhtutta*, 1108.
 सिङ्गारा *singhāra*, 1073.
 सिङ्गारा *singhāra*, 748, 1055.
 सिङ्गासन *singhāsan*, 777.
 सिङ्गौटा *singhauta*, 602.
 सिङ्गा *singa*, 483.
 सिङ्ग *singh*, 483, 1087.
 सिङ्गा *singha*, 784.
 सिङ्गी *singhi*, 688, 1101.
 सिङ्गवाहा *sinchwaha*, 915.
 सिङ्गकोहवा *sijkoḥhwa*, 1071.
 सिङ्गो *sinjo*, 489.
 सिङ्गोच *sinjoy*, 489.
 सिङ्गी *sitthi*, 1012.
 सिङ्गाह *sinrah*, 789.
 सिङ्गाहा *siraha*, 789.
 सिङ्गी *sirhi*, 319j.
 सिङ्गाना *sirhāna*, 638.
 सिङ्गानी *sirhāni*, 687, 638.
 सिङ्गल *sitlak*, 1449.
 सिङ्गलपाटी *sitalpāti*, 751.
 सिङ्गलबुक्नी *sitalbukni*, 1272.
 सिङ्गला *silla*, 765, 1449.
 सिङ्गला देवी *sila debi*, 1449.
 सिङ्गली *silli*, 1456.
 सिङ्गारा *sitāra*, 585.
 सिङ्गी *sili*, 977.
 सिङ्गी सार *siti sār*, 977.
 सिङ्गुचा *situa*, 319, 1030, 1267.
 सिङ्गुरिवाण्ड *situriyāḍ*, 1076.
 सिङ्गुचा *situha*, 535, 1030, 1267, 1408.
- सिङ्गु *sittu*, 1267.
 सिङ्गवार *sidhwāi*, 195.
 सिङ्गवानी *sidhwāni*, 639.
 सिङ्गा *sidha*, 1272.
 सिङ्गांत *sidhānt*, 1354.
 सिङ्गोरा *sindhora*, 662.
 सिङ्गेच *sineh*, 1314.
 सिङ्गेर के पानि *sineh ke pāni*, 1314.
 सिङ्गुर *sindur*, 1334.
 सिङ्गुर दान *sindur dān*, 1334.
 सिङ्गवा *sipwa*, 195, 243, 1256.
 सिङ्गवा *sipāwa*, 195, 200, 243.
 सिङ्गवा *sipāha*, 243.
 सिङ्गवाही *sipāhi*, 1449.
 सिङ्गौचा *sipāua*, 248.
 सिङ्ग *sib*, 1429, 1455, 1456.
 सिङ्ग चान्द *sib ans*, 1203.
 सिङ्ग नारैनी *sib nārāni*, 1429.
 सिङ्गोतर *sibotar*, 1209a.
 सिङ्गल *simal*, 20.
 सिङ्गल *simmal*, 194.
 सिङ्गार *siyār*, 1088.
 सिङ्गाह *sigāh*, 976, 996.
 सिङ्गाहा *siyāha* 1468a and b, 1470, 1471, 1472 ; Appendix, 6, 12.
 सिङ्गानी *sirhāni*, 637.
 सिङ्ग *sir*, 1451.
 सिङ्गी *sirki*, 815, 1234.
 सिङ्गाना *sirnāma*, 1487.
 सिङ्गी *sirni*, 1440.
 सिङ्गपचर *sirpachar*, 839.
 सिङ्गपचमी *sirpanchmi*, 839.
 सिङ्गपाना *sirpāya*, 195.
 सिङ्गमा *sirma*, 638.
 सिङ्गमान *sirmān*, 871.
 सिङ्गवा *sirwa*, 243.
 सिङ्गवाँची *sirwānsi*, 638.
 सिङ्गहटी *sirhatti*, 967k, 969.
 सिङ्गहण्ड *sirhant*, 966.
 सिङ्गहत *sirhat*, 57.

- सिरहथ *sirhath*, 55.
 सिरहान *sirhān*, 638.
 सिरहाना *sirhāna*, 688.
 सिरा *sira*, 1014, 1272.
 सिरावर *sirāur*, 885, 1006.
 सिरार *sirār*, 362.
 सिरारा *sirāra*, 364.
 सिरारी *sirāri*, 362.
 सिरौ *siri*, 973.
 सिरौ केबल *siri kebul*, 973.
 सिरुवा *sirua*, 1272.
 सिरुका *siruka*, 1074.
 सिरोर *siror*, 835.
 सिरोरा *sirora*, 1074.
 सिरौर *siraur*, 835.
 सिर *sir*, 404.
 सिरफन्ची *siraphchi*, 699.
 सिरुवट *siruat*, 626.
 सिरुवे *sirue*, 30.
 सिरुहट *sirhat*, 972.
 सिरुहन्ना *sirahra*, 749.
 सिरुवावट *sirawat*, 626.
 सिरुवेबा *siruba*, 1134.
 सिरुवे *sirube*, 1134.
 सिरुलौट *siraut*, 626.
 सिरुवा *sirua*, 383, 487, 573.
 सिरुली *siruli*, 82, 383, 539, 892; 894, 1265.
 सिरुवानी *sirvāni*, 1082, 1084.
 सिरुवकटनी *sirkatni*, 875.
 सिरुवकोहन्ना *sirkohra*, 1071.
 सिरुवफल *sirphul*, 762.
 सिरुवुवा *sirua*, 985.
 सिरुवुवा गोहमा *sirua gohuma*, 985.
 सिरुवन्ना *sirua*, 1381, 1384.
 सिरुवोर्नी *sirorni*, 319e.
 सिरुवोड़ा *sirora*, 1183.
 सिरुवोर *siror*, 1183.
 सीक *sik*, 648, 652.
 सीक *sink*, 447, 546.
 सीकर *sikar*, 33, 107, 198.
 सीकर *sinkar*, 33.
 सीका *sika*, 648, 651.
 सीका *sinka*, 648.
 सीख *sikh*, 447, 711.
 सीख *sinkh*, 447, 474, 546.
 सीठ *sith*, 848.
 सीठा *sitha*, 937, 952.
 सीड़ा *sira*, 789.
 सीही *sirhi*, 429.
 सीतल *sital*, 1449.
 सीधा *sidha*, 1272.
 सीना *sina*, 1011.
 सीपतनी *sipatni*, 1211.
 सीपी *sipi*, 770, 1267.
 सीम *sim*, 1073.
 सीरक *sirak*, 731.
 सीरग *sirag*, 731.
 सीरा *sira*, 1015, 1465.
 सील *sil*, 581, 626, 1451.
 सीस *sis*, 958, 986.
 सीसा *sisā*, 383, 561, 958.
 सीसा डरेवाला *sisā dharewāla*, 561.
 सुवरा *suara*, 1183.
 सुवा *sua*, 957.
 सुवा बावे है *sua baive hai*, 957.
 सुवाप्र *suāeb*, 987.
 सुवासिन *suāsin*, 1295.
 सुवारल *suiāl*, 1004.
 सुवा *suiya*, 957, 987.
 सुवा गेल *suiya gail*, 957.
 सुवा *suiā*, 657.
 सुई *sui*, 499, 503.
 सुकरवांत *sukarvānt*, 1173.
 सुकल *sukl*, 1081.
 सुकल पख *sukl pakh*, 1081.
 सुकला *sukla*, 1087.
 सुख *sukh*, 1090.
 सुखठा *sukhtha*, 1074.
 सुखड़ा *sukhra* 1074, 1453.

- सुखभाजी *sukhhāmi*, 1173.
 सुखराती *sukhrāti*, 1090, 1423.
 सुखले *sukhle*, 1088.
 सुखवन *sukhvan*, 1030.
 सुख सुख *sukh sukh*, 990.
 सुखार *sukhār*, 1077.
 सुखैनी *sukhaini*, 1458.
 सुगन्ध *sugand*, 468.
 सुगन्ध कोविडा *sugand kokila*, 468.
 सुगन्ध वाडा *sugand wāla*, 468.
 सुगन्दा *sugra*, 789.
 सुगन्दा *sugra*, 1000.
 सुगही *sugāhi*, 411.
 सुंगार *sungār*, 1006.
 सुग्गी *suggi*, 856.
 सुजनी *sujni*, 637.
 सुडा *sunda*, 1074.
 सुतरिवाप्रह *sutariyaeI*, 1076.
 सुतरी *sutri*, 123, 243, 362.
 सुतली *sutli*, 123.
 सुतवान *sutwān*, 503.
 सुतारी *sutāri*, 482, 589.
 सुताली *sutāli*, 482.
 सुतिहार *sutihār*, 1244.
 सुतुहा *sutuha*, 319e.
 सुतेमान *sutemān*, 503.
 सुतिहा *suttiha*, 923.
 सुती *sutti*, 922.
 सुथनी *suthni*, 1060.
 सुथरी *suthri*, 123.
 सुंदरी *sundri*, 1074.
 सुध *sudh*, 1289, 1486.
 सुधाबधा *sudhabadha*, 1286.
 सुधाबधा करब *sudhabadha karab*, 1286.
 सुन *sun*, 29, 1451.
 सुनु *sunu*, 1084, 1085, 1087, 1088.
 सुने *sune*, 1486.
 सुन्न *sunm*, 408, 922.
 सुन्नत *sunnat*, 386, 1415.
 सुपतिवा *supatiya*, 1262.
 सुपही *supahi*, 912.
 सुपारी *supāri*, 1056.
 सुपौवा *supaua*, 414.
 सुपेद *suphed*, 1016, 1138.
 सुपेद बगन्हा *suphed bagchhalla*,
 1138.
 सुमन्ही *sumkatti*, 388.
 सुमङ्गी *sumangli*, 1328.
 सुमन्तरास *sumtarās*, 388.
 सुमरनी *sumarni*, 781.
 सुमिरनी *sumirni*, 781.
 सुमुत *sumut*, 877.
 सुमेर *sumer*, 781.
 सुम्बा *sumba*, 582.
 सुम्बा *sumbha*, 413.
 सुम्मा *summa*, 412.
 सुम्मी *summi*, 413.
 सुम्हा *sumha*, 582.
 सुतंन्निवाँ *surtwaniyān*, 238.
 सुरका *surka*, 126, 1074, 1272.
 सुरका चूरा *surka chūra*, 1272.
 सुरकी *surki*, 571.
 सुरकी *surkhi*, 431, 1267.
 सुरती *surti*, 1023.
 सुरपुर *surpur*, 1025.
 सुरफा *surpha*, 1217.
 सुरफान *surphān*, 1217, 1226.
 सुरवरिवा *surbariya*, 1183.
 सुरवार *surbār*, 1183.
 सुरमई *surmai*, 1043.
 सुरमा *surma*, 747.
 सुरवारी *surwāri*, 1183.
 सुरवाड *surwāl*, 727, 746.
 सुरसा *sursa*, 414.
 सुराकी *surāki*, 589.
 सुराही *surāhi*, 697, 713.
 सुरख *surukh*, 1043.
 सुरजकोँहड़ा *surujkohra*, 1071.
 सुरज-मुखी *surujmukhi*, 1263.
 सुरैतिन *suraitin*, 1280.

- सुतन्वनिर्घा *surtcaniyān*, 238.
 सुल्तान *sultān*, 478, 748.
 सुल्तान लोही *sultān lorhi*, 748.
 सुलभ *sulabh*, 1454.
 सुलभ सगुन *sulabh sagun*, 1454.
 सुलाखी *sulākhi*, 589.
 सुसुवा *suswa*, 545.
 सुहारी *suhāri*, 1272.
 सुहाली *suhāli*, 1378.
 सुहर *sūar*, 1125.
 सुहा *sūa*, 494, 499, 503, 589, 987.
 सुई *sūi*, 24, 589, 644, 1004, 1383.
 सुई फेंकलकैक *sūi phenkalkaik*, 1004.
 सुक *sūk*, 1008.
 सुंग *sūng*, 958, 961.
 सुगर *sūgar*, 1125.
 सुगा *sūga*, 975.
 सुगा पक्षी *sūga pankhi*, 975.
 सुंग *sūng*, 958, 961.
 सुज *sūj*, 494.
 सुजी *sūji*, 1272.
 सुंद *sūnr*, 958.
 सुंदा *sūnda*, 1074.
 सुंरी *sūnri*, 1074.
 सुंद *sūnr*, 961, 1074.
 सुंदा *sūnrha*, 961.
 सुत *sūt*, 123, 238, 425, 1489.
 सुत सिखा *sut sikha*, 736.
 सुता *sūta*, 123.
 सुति *suti*, 765.
 सुती *sūti*, 1234.
 सुते *sūte*, 572.
 सुद *sūd*, 1475, 1478, 1482.
 सुद पर रुपैया काढ़ब *sūd par rupaiya kārhab*, 1478.
 सुद भरना *sūd bharna*, 1482.
 सुदी *sūdi*, 1475, 1485.
 सुदी रुपैया *sūdi rupaiya*, 1475, 1485.
 सुप *sūp*, 47, 440, 603, 604.
 सुते *sūrt*, 238.
 सुर *sūr*, 1087.
 सुंसा *sūnsa*, 545.
 सुंजत *seūt*, 789.
 सुंजिया *sejiya*, 636.
 सुंफाली *sephāli*, 713.
 सुंदरा *sedra*, 1236.
 सुंबारा *sebāra*, 373.
 सुंमार *semār*, 319.
 सुंरंगा *seranga*, 494.
 सुंरहा *serha*, 713.
 सुंरही *serhi*, 912, 194.
 सुंराजब *serāeb*, 1422.
 सुंवर *semwai*, 1272.
 सुंवटा *sewta*, 860.
 सुंवठा *sewtha*, 860.
 सुंवता *sewta*, 237.
 सुंवती *sewti*, 716.
 सुंवराहा *sewrāha*, 1264.
 सुंवत *sewāt*, 835.
 सुंवार *sewār*, 319.
 सुंवार *semwār*, 319.
 सुंसना *sesnāg*, 1445.
 सेहुना *sehuna*, 516.
 सेहुनी *sehuni*, 516, 539.
 सेहोरना *sehorna*, 319e.
 से *se*, 235, 1026, 1485.
 सें *señ*, 414, 867, 1183.
 सेंकी *señki*, 1317.
 सेथन *sethan*, 53, 55.
 सेहा *serha*, 966g.
 सेही *serhi*, 1183.
 सेंदुर *sendur*, 747.
 सेनी *seni*, 467, 711.
 सेनुर *senur*, 747, 1308, 1334, 1385, 1435, 1483.
 सेनुर दान *senur dān*, 1334.
 सेब *seb*, 26.
 सेम *sem*, 1073.
 सेमल *semal*, 194.
 सेमा *sema*, 1073.

शेर *ser*, 1502, 1503.
 शेरङ्ग *serang*, 494.
 शेरी *seri*, 906, 1198.
 शेरी नौसना *seri nausatta*, 906.
 सेह *sel*, 109.
 सेली *seli*, 109.
 सेह *selh*, 1119.
 सेहह *selhal*, 1119.
 सेहा *selha*, 975, 976, 977, 978.
 सेही *selhi*, 1119.
 सेव *seo*, 26, 1272.
 सेवर *sewar*, 1264.
 सेकन्दा *saikra*, 1479.
 सेनार *sainār*, 949.
 सेरन्वाह *sairwah*, 949.
 सेई *saiñeñ*, 1274.
 सेक *saiḱ*, 305.
 सेका *saika*, 305.
 सेडा *saindha*, 1272.
 सेन *sain*, 711, 949.
 सेन बराण्ड *sain bardēb*, 949.
 सेयद *saiyad*, 763.
 सेयन *saiyan*, 1073, 1183.
 सेर *sair*, 949.
 सेर (चाँड़ or डोस) चहाण्ड *sair (chānr
 or dhos) chaldēb*, 949.
 सेरा *saira*, 48.
 सेला *saila*, 15, 236, 938.
 सेररी *soiri*, 1398, 1402.
 सेररी लिपार *soiri lipāi*, 1402.
 सेरवा *soiya*, 923.
 सेकन्ना *sokna*, 965.
 सेगिला *sogila*, 661.
 सेजनी *sojni*, 637.
 सेजौचा *sojhaua*, 828.
 सेजौचा जोन *sojhaua jot*, 828.
 सेठौरा *sothaura*, 1399.
 सेठौरा *sonthaura*, 1399.
 सेतही *sothi*, 923.
 सेन *son*, 1047.

सोमन्दुचा *songarhua*, 514.
 सोमन्दुचा सोनार *songarhua sonr*,
 514.
 सोमड्डा *sonahula*, 1043.
 सोनार *sonār*, 514, 914.
 सोनारी *sonāri*, Appendix, 14.
 सोपारी *sopāri*, 1056.
 सोबरना *sobarna*, 888, 1456.
 सोबरा *sobra*, 965o.
 सोमनी *somni*, 1125.
 सोमरा *somra*, 819.
 सोमता *somāta*, 839.
 सोरहा *sorha*, 882.
 सोरही *sorhi*, 882, 883, 885, 936.
 सोरारी *sorāri*, 1400.
 सोराही *sorāhi*, 697, 711, 713, 749.
 सोलकन्ह *solkanh*, 1217.
 सोहजन *sohjan*, 1073.
 सोहनी *sothhi*, 852.
 सोहना *sohna*, 516.
 सोहनी *sohni*, 516, 867.
 सोहरना *soharna*, 319e.
 सोहार *sohāi*, 869.
 सोहाग *sohāg*, 1381, 1384.
 सोहाग के अतर *sohag ke atar*, 1381.
 सोहाग पुरा *sohāg pura*, 1381, 1384.
 सोहागा *sohāga*, 553, 1383.
 सोहागिन *sohāgin*, 1277, 1378.
 सोहागिनि *sohāgini*, 1369, 1383.
 सोहारी *sohāri*, 1272.
 सोहिजन *sohijan*, 1073.
 सोचा *soa*, 922.
 सोर *soi*, 922.
 सोर *soer*, 1398, 1413.
 सोर लिपार *soer lipāi*, 1413.
 सोक *sok*, 639.
 सोकन *sokan*, 1134.
 सोखा *sokha*, 1453.
 सोग *sog*, 639.
 सोडा *sota*, 654.

सोंटा *sonta*, 103, 377, 390, 654.
 सोंठ *sonth*, 184.
 सोन *sot*, 922.
 सोना *sota*, 237, 922.
 सोतिन *sofin*, 1276.
 सोन *son*, 1272.
 सोना *sona*, 753, 1090, 1173.
 सोना सोला *sona hola*, 1173.
 सोनी *soni*, 514.
 सोने *sone*, 1383.
 सोरा *sora*, 370; Appendix, 14.
 सोहन *sohan*, 403, 591.
 सोहब *sohab*, 867.
 सोहने *sohen*, 403.
 सोदागन्री *saudāgri*, 1488.
 सोदागन्री के माल *saudāgri ke mal*,
 1488.
 सौ *sau*, 823.

सौंगी *saungi*, 208, 212, 213, 224.
 सौंगी के गारी *saungi ke gāri*, 224.
 सौंगी गारी *saungi gāri*, 148.
 सौन *saut*, 765.
 सौतिन *sautin*, 765, 1276.
 सौथी *sauthi*, 716.
 सौंदर *saundar*, 1263.
 सौंप *saumph*, 1073.
 सौंपी *saumphī*, 373.
 सौर *saur*, 1398.
 सौर लिपार *saur lipāi*, 1402.
 सौरा *saunra*, 1134.
 सौरी *sauri*, 1398, 1409.
 सौसन *sausan*, 585.
 सौसन के टट्टी *sausan ke tattī*, 585.
 सामी *swāti*, 1084, 1090.
 सामी *swāmi*, 1274.
 सौष *srautra*, 1356.

॥ ह ॥

ह० *ha*, 1116, 1275.
 हंकवा *hankwa*, 294, 942.
 हंकनिहार *hanknihār*, 942.
 हकमैती *hakmaiti*, 1201.
 हकाक *hakkāk*, 538.
 हजाम *hajām*, 383, 1326.
 हजार *hajār*, 585.
 हजार बिन *hajār bin*, 585.
 हजरिया *hajuriya*, 733.
 हटका *hatka*, 1256.
 हटवई *hatvāi*, 914.
 हटवा *hatwa*, 914.
 हटवार *hatwāi*, 914.
 हटवे *hatwe*, 914.
 हठा *hatthā*, 838, 841.
 हठा बरद *hattha barad*, 841.
 हठीला *hatthīla*, 1456.
 हड्डा *hadda*, 1074, 1075, 1183.
 हड्डी *haddi*, 984.

हडका *harka*, 68.
 हडवर *harvar*, 842.
 हडवाय *hanrōāy*, 131.
 हडहरा *harhara*, 956.
 हडहा *harha*, 956.
 हरा *hara*, 1183.
 हरिदा *harira*, 726.
 हरिया *hanriya*, 69, 83, 139, 368,
 432, 465, 713.
 हंडोलवा *hanrolwa*, 268.
 हंडोला *hanrola*, 713.
 हराुरी *harauri*, 844.
 हतयारवा *hateyarwa*, 1177.
 हथा *handā*, 251, 268, 669.
 हथा *handha*, 268.
 हथा *hattha*, 64, 307, 363, 416, 510,
 597, 915, 1129.
 हथा चरक *hattha charak*, 597.
 हथी *hatthi*, 510, 613.

- हथू *hatthu*, 510.
 हथ *hath*, 564.
 हथ अकुरी *hath akuri*, 564.
 ह उकुरी *hath ukri*, 564.
 हथकड़ *hathkar*, 335g.
 हथकड़ा *hathkara*, 335g.
 हथकर *hathkar*, 335g.
 हथकरा *hathkara*, 416.
 हथकल *hathkal*, 416.
 हथकुटा *hathkutta*, 431.
 हथगर *hathgar*, 335g.
 हथघिसेट *hathghiset*, 801.
 हथरा *hathra*, 443, 621.
 हथनी *hathni*, 1129.
 हथपानी *hathpāni*, 579.
 हथपेर *hathpher*, 1476.
 हथबरही *hathbarhi*, 116, 930.
 हथबै *hathbai*, 1183.
 हथरा *hathra*, 335g, 416, 443, 621.
 हथवानी *hathwāni*, 579.
 हथवासा *hanthwāsa*, 185.
 हथवांसा *hathwānsa*, 223.
 हथवाधा *hathwāha*, 915.
 हथहर *hathhar*, 335g, 688.
 हथा *hatha*, 64, 307, 335g, 363, 490.
 हथिनी *hathini*, 1129.
 हथिया *hathiya*, 1074, 1082, 1089.
 हथिया सुन्दा *hathiya sunda*, 1074.
 हथुनी *hathuni*, 1005.
 हथैला *hathaila*, 284.
 हथौषा *hathaua*, 831.
 हथौड़ा *hathaura*, 523.
 हथौना *hathaua*, 378, 713.
 हथौर *hathaur*, 410.
 हथौरा *hathaura*, 397, 410, 523, 552.
 हथौरी *hathauri*, 397, 512, 539, 560,
 410, 589, 552, 624.
 हनुषा *hanua*, 1173.
 हन्ध उधार *hanth udhār*, 1476.
 हन्ना *hanna*, 409.
 हफनी *haphni*, 1181.
 हबसाप्रह *habsāēl*, 957.
 हबेली *habeli*, 1234, 1254, 1275.
 हम *ham*, 1087, 1092.
 हमचा *hamcha*, 978.
 हमार *hamar*, 859.
 हमार बिहनार मारल गेल *hamar bihnāi, māral gel*, 859.
 हमहूँ *hamhūñ*, 1084.
 हमाम *hamām*, 706.
 हमाम दिखा *hamām dista*, 706.
 हमार *hamār*, 1116.
 हमार *hammar*, 864.
 हमार बनुसार गेल *hammar banusār bhel*, 864.
 हकैति *harkati*, 363.
 हर *har*, 1, 6, 328, 817, 846, 1006, 1087.
 हरका *harka*, 68.
 हरकाह *harkāh*, 1098.
 हरकाधा *harkāha*, 1098.
 हरकी *harkhi*, 867.
 हरखुगानी *harkhugāni*, 840.
 हरखुली *harkhuli*, 840.
 हरखुजल *harkhūjal*, 840.
 हरखोलानी *harkholāni*, 840.
 हरखोलिया *harkholiya*, 840.
 हरखोली *harkholi*, 840.
 हर चलाप्रब *har chaldēb*, 817.
 हर चाँड़ी *har chāñri*, 24.
 हरजा *harja*, 1488.
 हरजिन्सा *harjinsa*, 806.
 हरजोषार *harjoār*, 840.
 हर जोतब *har jotab*, 817.
 हरकुटाब *harchhutāo*, 840.
 हरकुट्टन *harchhuttan*, 840.
 हरदा *harda*, 1074.
 हरदी *hardi*, 1073, 1308, 1404, 1409.
 हरदी गूड़ *hardi gūr*, 1404, 1409.

हरदी चहाप्रब *hardi charhāeb*, 1308,
1311.

हरना *harna*, 956.

हर नाथ *har nādh*, 817.

हर नाथा *har nādha*, 17.

हर पहाडा *har pahṭa*, 846.

हरफोरवा *harphorwa*, 959.

हरफोरवा केराब *harphorwa kerāb*,
959.

हर बहब *har bahab*, 817.

हरबिनार *har binār*, 840.

हर भक्षा *harbhaxja*, 846.

हरमनचकर *harmahan'ar*, 839.

हरमजुतर *harmahutar*, 839.

हरमभूरत *harma'ūrat*, 1433.

हरमोहनतर *harmoni'tar*, 839.

हरमोतर *harmoni'tar*, 1433.

हरंहरवा *har'rahwa*, 956.

हरनरा *harra*, 996.

हर रबी *har radī*, 17.

हरवत *harvat*, 839

हरवार *harwar*, 1186.

हरवा *harwa*, 765.

हरवाच *harvāc*, 842, 1184.

हरवाच *ha. wāc*, 842.

हरवाची *harvācī*, 833, 842, 1186.

हरवाची *harvācī*, 833.

हर सज्जा *har sajjā*, 846.

हर समत *har samat*, 839.

हर समौच *har samaudh*, 818, 839.

हरसा *harṣa*, 178, 274.

हर सांगत *har sāngat*, 8.

हरसोदन *harsoodhan*, 1434.

हरनरा *har'nara*, 758.

हरदी *harāḍī*, 833, 843, 1201.

हराठा *harāṭha*, 838.

हराठी *harāṭhī*, 1096.

हराम *harām*, 1125.

हराही *harāhī*, 1201.

हरि *hari*, 414.

हरिचर *hariar*, 996.

हरिवन्ध *haribans*, 1451.

हरिरान वरम *harirānī barm*, 1456.

हरिघार *harīyār*, 197.

हरिस *haris*, 5, 1308, 1349.

हरिजा *harisa*, 275.

हरिहर *harihar*, 1201.

हरिहर नाथ *harihar nāth*, 1456.

हरिहरा *hariha. a*, 1201.

हरिहरी *ha. ihari*, 1201.

हरिजा *harina*, 1156.

हरी *hari*, 1201.

हरीत *ha. īt*, 5.

हरीया *harīya*, 841.

हरीया बैल *harīya bail*, 841.

हरीया *ha. eha*, 994.

हरीया *harīya*, 1183.

हरीया *ha. auri*, 1186.

हरीया *ha. auri*, 842, 1186.

हल *hal*, 1.

हलका *halka*, 784.

हलखा *halxha*, 388.

हलदी *halḍī*, 1070.

हलमचनी *halmacnāni*, 233.

हलवार *halwāḍī*, 454.

हलवाचारी *halwācīchāi*, 987.

हलवी *hal'vī*, 801.

हलाही *halāhī*, 1139.

हलुवा *halua*, 1272.

हलुवार *halu'vāḍī*, 296, 454, 463.

हलुक *haluk*, 799, 800.

हवा *hawāḍī*, 335.

हवेही *havēhī*, 1234.

हसतना *hasatnā*, 451.

हसर *hasar*, 1451.

हसर करब *hasar karab*, 1451.

हंसुवा *hansua*, 73, 328, 377.

हंसुही *hansuli*, 74, 377, 765, 1439.

बल *hast*, 1082, 1085.
 बलौ *hasti*, 568.
 बलबूदी *hastbūdi*, 1222.
 बाँ *hān*, 1085.
 बाऊ *hāü*, 1458.
 बाँकब *hānkab*, 870.
 बाकिम *hākim*, 1184.
 बाकिम उक्कमी *hākim hukmi*, 1184.
 बाकिमी *hākimi*, 1470.
 बाकिमी हिस्सा *hākimi hissa*, 1470.
 बाँकी *hānki*, 870.
 बाँको *hānko*, 1087.
 बाँगी *hāngi*, 607.
 बाट *hāt*, 1070.
 बाड़ा *hāra*, 956, 1183.
 बाँड़ा *hānra*, 268.
 बादिम *hārin*, 1197.
 बाड़ी *hāri*, 1197.
 बाँड़ी *hānri*, 69, 139, 430, 432,
 506, 713.
 बाँड़ा *hānrha*, 669.
 बाता *hāta*, 832, 1234.
 बाता बाला *hāta wāla*, 832.
 बातुल *hātul*, 416.
 बाथ *hāth*, 356, 655, 1490.
 बाँथ *hānth*, 867, 1451, 1490.
 बाथक *hāthak*, 1070.
 बाँथकल *hānthkal*, 4116.
 बाथरु *hāthar*, 621.
 बाथर *hāthar*, 443.
 बाँथसें निकारुब *hānth señ nikāeb*, 867.
 बाथी *hāthi*, 1084, 1129.
 बाथे *hāthe*, 478.
 बाँथ *hāmph*, 1181.
 बाबुस *hābus*, 990, 1272.
 बाँभर *hāmmar*, 487.
 बार *hār*, 233, 765, 1391.
 बारवाला *hār wāla*, 1156.
 हाल *hāl*, 163, 222, 802, 827,
 964, 1215, 1223.

हाल उपारजित *hāl upārjit*, 1215.
 हाल बासिली *hāl hāsili*, 1223.
 बाबन *hāwan*,
 बाबन दस्ता *hāwan dasta*, 706.
 बाशो *hāsho*, 1465.
 बासिल *shāül*, 1076, 1077.
 बासिली *hāsili*, 1223.
 बाँसु *hānsu*, 328.
 हिक्का *hikka*, 302.
 हिंगोरी *hingori*, 662.
 हिच्छा *hichchha*, 447.
 हिनुवाना *hinuāna*, 1064.
 हिवा *hiya*, 1070.
 हिराबोल *hiraöl*, 851.
 हिरात *hirāt*, 1153.
 हिरांत *hirānt*, 1148.
 हिवाब *hisāb*, 1468a, 1470, 1472.
 हिवाब बिकरी गला *hisāb bikri
galla*, 1468a, 1470, 1472 ;
 Appendix, 7.
 हिस्सा *hissa*, 1214, 1470 ; Appen-
 dix, 14.
 हिस्सा बास *hissa khās*, Appendix, 14.
 हिस्सा पटिदारौ *hissa patidāri*, 1214.
 हिस्सेदार *hissedār*, 1208, 1214.
 ही *hi*, 1446.
 हीक *hink*, 302.
 हीन *hin*, 1084.
 उक्कमी *hukmi*, 1184.
 उक्कमत *hukumat*, 1201.
 उक्का *hukka*, 472, 1026, 1452.
 उक्का (or उक्का तामाकु) बन्ध करव *hukka
(or hukka tamāku) band karab*,
 1452.
 ऊज्जाना *hujtāna*, 1198.
 ऊँडियाना *hundiyanā*, 1474.
 ऊँडियावन *hundiyanāwan*, 1474.
 उण्डा *hunda*, 903, 1221, 1483.
 उण्डा भारा *hunda bhāra*, 1483.
 उण्डी *hundi*, 1474, 1487.

उषी पत्री *hundi patri*, 1487.
 उत्था *huttha*, 653.
 उमना *humna*, 12.
 उमेख *humel*, 765.
 उमा *humma*, 1458.
 उरका *hurka*, 1250.
 उर पटेख *hur petal*, 1098.
 उररा *hurra*, 653.
 उरसा *hursa*, 778.
 उलुक *huluk*, 585.
 उसुमन्दान *husundān*, 711.
 हूर *hūr*, 29, 89, 471.
 हूरा *hūra*, 29, 653, 848, 868.
 हूल *hūl*, 748.
 हंगरहा *hengaiha*, 829.
 हंगही *hengahi*, 33, 118.
 हंगप्रब *hengāëb*, 830.
 हंगती *hengti*, 808, 1016, 1019.
 हंगा *henga*, 30, 36, 830.
 हंगा चलाप्रब *henga chalāëb*, 830.
 हंगी *hengi*, 31.
 हेर *her*, 1124.
 हेर *her*, 1113.
 हेरा *hera*, 1132.
 हेरा जाप्रब *hera jāëb*, 1132.
 हे *hai*, 655, 957, 964, 987, 1001,
 1004.

है *hain*, 568.
 हैकल *haikal*, 765.
 हैलक *hailak*, 765.
 होरसा *horsa*, 778.
 होरसा *horha*, 877, 957, 984, 990,
 1272.
 होलसा *holha*, 877, 957, 990.
 होहि *hoñhi*, 1087.
 हो *ho*, 1486.
 होप्रत *hoet*, 363.
 होप्रब *hoëb*, 1158.
 होप्र ला *hoe la*, 851.
 होप्र *hoe*, 1088.
 होखे *hokhe*, 965, 1090.
 हो गैल *ho gail*, 1485.
 होत *hot*, 1089.
 होबो *hoboñ*, 1092.
 होम *hom*, 1332.
 होय *hoy*, 548.
 होला *hola*, 1088, 1173.
 होली *holi*, 1198.
 होली खेला *holi khetāi*, 1198.
 होदरी *haudri*, 323.
 होज *hauj*, 321.
 होद *haud*, 316, 321.
 होदी *haudi*, 314.

